



MOTION CONTROLLER

What is the newest in a motion wave ?

QSERIES



Mitsubishi Electric Corporation Nagoya Works is a factory certified for ISO14001 (standards for environmental management systems) and ISO9001 (standards for quality assurance management systems)



The Evolution Has Begun-The Motion Controller The answer to all of your needs!

MOTION CONTROLLER Q SERIES

Introducing the Motion Controller Q Series, meeting the needs for higher performance and smaller size to satisfy high-speed motion control applications! Compatible with the Q Series PLC (Platform), which incorporates Multiple CPU technology, the Motion CPU and PLC CPU are selectable and work in parallel to provide greater flexibility and unmatched performance. A large-scale control system (Up to 96 axes per system) can be created using an extremely compact package as Q Series PLC.

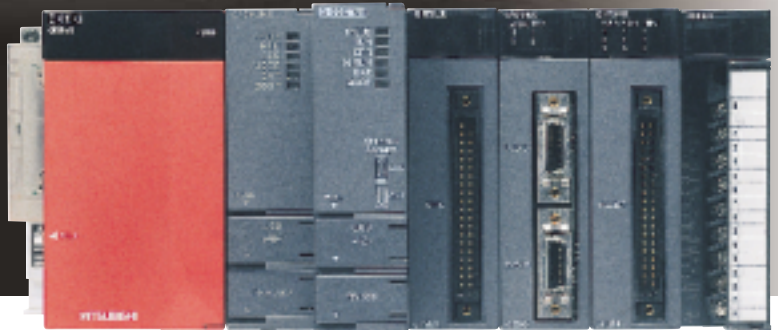

High-Speed Motion Control

- Cam speed has increased and operation tact time is shortened with a motion operation cycle of 0.88ms (4 times the conventional cycle). (When using the SV13 and 8-axes control.)
- Accuracy for the synchronous and speed/position control is improved by reducing the command communication cycle to the servo amplifier to 0.88ms (4 times the conventional cycle).
- Motion CPU module contains a 64-bit RISC processor for motion control and event processing. Large volumes of data can be communicated with a personal computer without affecting motion control performance.
- Compatible with the high-speed sequence processing of the MELSEC-Q Series PLC CPU (Platform). (Basic command scan time of 34ns using the Q25HCPU)
- Various motion functions are included, such as multi-axis interpolation functions, speed control, software Cam profiles and locus control.
- Control with suppressed variation in response time is realized using the Motion SFC programming method as a flowchart.

CONTENTS

Main Features	1
System Configuration	3
Products Line-up	5
Multiple CPU System	7
Motion SFC Program	9
SV13 (Conveyor Assembly Use)	19
SV22 (Automatic Machinery Use)	23
Overview of CPU Performance	27
Device Configuration	29
Combinations of Servo Amplifiers and Servomotors	31
Exterior Dimensions	33

Realizing Compact Size and Savings in Space

- The industry minimum level of mounting area and volume is realized by using the same hardware architecture as the MELSEC-Q Series PLC CPU. (Volume: 1/3, Area: 60%)
- Additional savings in space and cost may be realized using a 12-slot base.

Q Series Multiple CPU System

- The power supply module, base unit, and I/O modules of the MELSEC-Q Series PLC can be shared.
 - Control processing is distributed to each CPU module among the Multiple CPU system, and it also corresponds to the intelligent control system.
 - Personal computer technology is utilized using a PC (Personal Computer) CPU module.
- ※ A personal computer CPU is the product of CONTEC, Ltd.

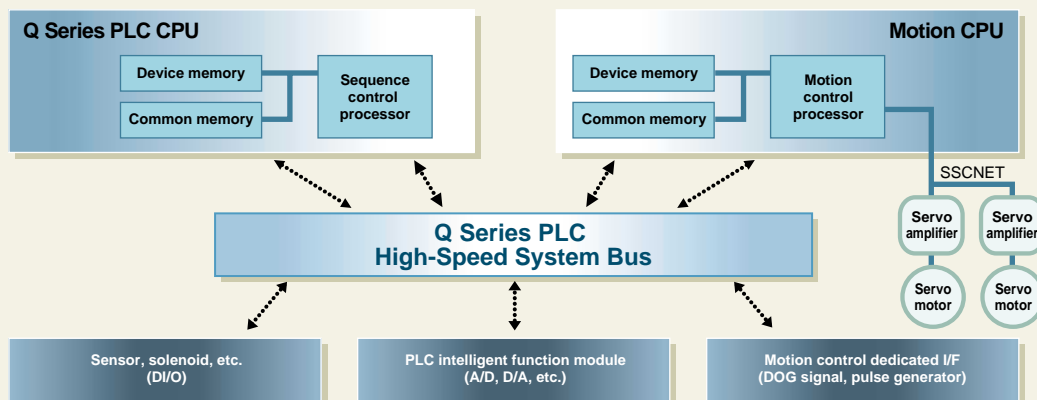

Greater Flexibility

- Individual CPU modules for PLC control and motion control allow for the economical selection of optimized CPU's for the system.
- Up to 4 CPU modules can be freely selected in the Multiple CPU system. (1 PLC CPU must be used.)
- Up to 96 axes can be controlled per 1 system in the Multiple CPU system. (When using 3 modules of Q173CPUN.)

Controlling via Mitsubishi SSCNET

- A synchronous and absolute system for the servomotor can be easily composed using the high-speed serial communication method.
- Simple wiring by quick release connection using connectors between the Motion controller and servo amplifiers.
- Servo amplifiers for up to 32 axes can be batch controlled with 1 CPU.
- Servomotor of various capacities from 10W to 55kW can be controlled.
- Motor information such as torque, speed, and position can be batch monitored with the controller using the digital oscilloscope function.

※ SSCNET: Servo System Controller NETWORK

System Configuration

Flexible High-Speed Motion Control System Achieved with Multiple CPU.

- Compatible with the Q Series PLC (Platform) in the Multiple CPU system.
- The appropriate CPU modules for PLC control and motion control can be selected to meet the application requirements.
- The Multiple CPU configuration allows up to 4 CPU modules to be selected. (1 PLC CPU must be used.)
- Up to 96 axes of servomotors per system can be controlled by using 3 modules of Q173CPUN.

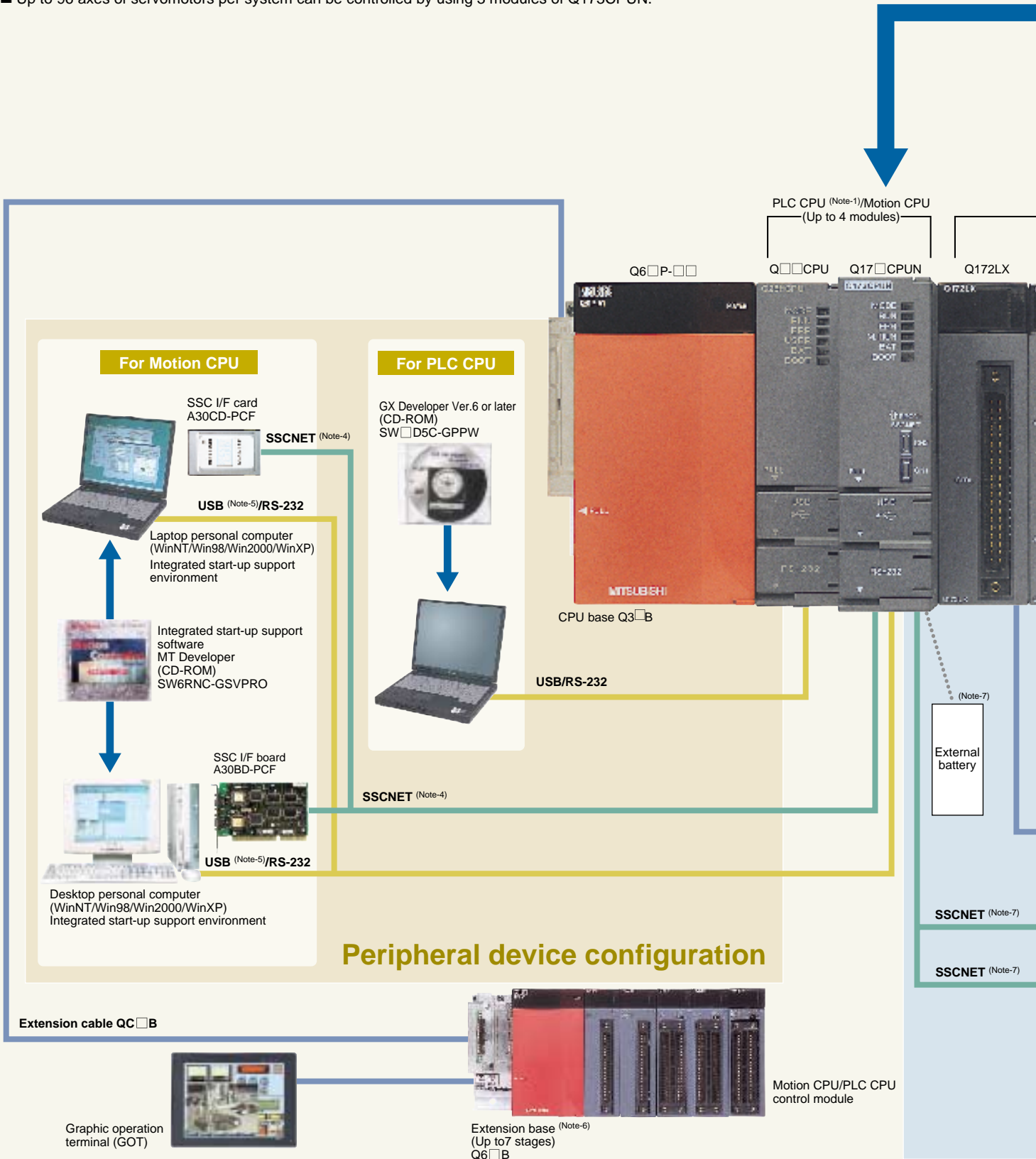

Operating system software line-up

OS software(FD)
SW6RN-SV □□□□

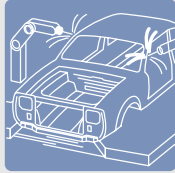

Conveyor Assembly Use Motion SFC **SV13**

Provides constant-speed control, speed control, 1 to 4-axes linear interpolation and 2-axes circular interpolation, etc. Ideal for use in conveyors and assembly machines.

- Electronic component assembly
- Inserter
- Feeder
- Molder
- Loader/Unloader
- Bonding machine
- X-Y table
- Conveying equipment
- Paint applicator
- Chip mounter
- Wafer slicer

Dedicated language

- Linear interpolation (1 to 4-axes)
- Circular interpolation
- Helical interpolation
- Constant-speed control
- Fixed-pitch feed
- Speed control
- Speed switching control
- Speed-position switching



Automatic Machinery Use Motion SFC **SV22**

Provides simultaneous control of the multiple servomotors and software Cam control. Ideal for use in automatic machinery.

- Press feeder
- Food processing
- Food packaging
- Winding machine
- Spinning machine
- Spinning machine
- Textile machine
- Printing machine
- Book binder
- Paper-making machine
- Tire molder
- Knitting machine

Mechanical support language

- Synchronous control
- Electronic shaft
- Electronic Cam
- Electronic clutch
- Draw control

Motion CPU control (Note-2)
modules

PLC CPU control (Note-3)
modules

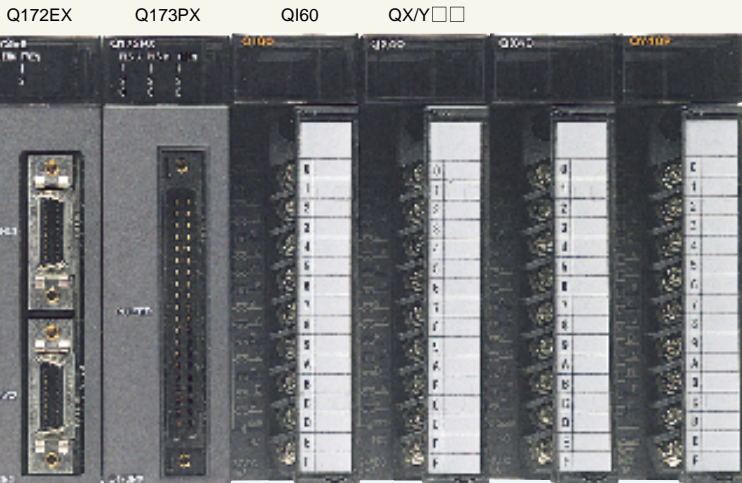

(Note-1) : The PLC CPU for Multiple CPU can be used in Q-mode.

(Note-2) : The Motion CPU control module which can be accessed from the PLC CPU is only input module.

(Note-3) : The other CPU control module cannot be accessed from the Motion CPU.

(Note-4) : Only 1 personal computer can be connected via SSCNET.

(Note-5) : USB cannot be used in Windows NT® 4.0.

(Note-6) : The module installed in the QA1S6□□B cannot be controlled in the Motion CPU.

(Note-7) : The external battery for backup of the parameter/program is required at the continuously power off for 1000 hours or more. Refer to "SSCNET connecting method" (Page 30) for connection between the Motion CPU module and servo amplifier/external battery.

(Note-8) : The operation cycle is 1.77ms or more using the MR-H□BN.

(Note-9) : When selecting an absolute position system in the MR-J2M-B, connect the battery unit "MR-J2M-BT".

(Note-10) : Coming soon!

Device configuration

Motion CPU input/output
(Up to 256 points)

External interrupt input (16 points)



Manual pulse generator (3 units per module)
MR-HDP01



Serial absolute synchronous encoder
(2 units per module)
MR-HENC

Servo external signal
(FLS, RLS, STOP, DOG/CHANGE) X 8 axes

Servo amplifier MR-J2M-P8B



Terminal connector
MR-A-TM

Battery unit
MR-J2M-BT (Note-9)

Servo amplifier
MR-H□BN (Note-8)
MR-J2S-□B
MR-J2-□B
MR-J2-03B5
Vector inverter (Note-10)
FR-V5□0-□

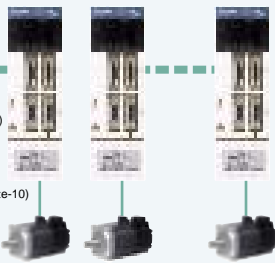

Terminal connector
MR-TM
MR-A-TM

Servomotor
/Motor for inverter (Note-10)

Number of servo amplifier/vector inverter (Note-10) SSCNET systems (8 axes per system)
• Q173CPUN: 4 systems (Up to 32 axes) • Q172CPUN: 1 system (Up to 8 axes)

Product-Line-up

■ Motion CPU module

Q173CPUN (Up to 32 axes control)



Items		Specifications
Number of control axes		Up to 32 axes
Operation cycle (default)	SV13	0.88ms : 1 to 8 axes 1.77ms : 9 to 16 axes 3.55ms : 17 to 32 axes
	SV22	0.88ms : 1 to 4 axes 1.77ms : 5 to 12 axes 3.55ms : 13 to 24 axes 7.11ms : 25 to 32 axes
Servo amplifier		External servo amplifiers are connected via SSCNET
Peripheral I/F		USB/RS-232/SSCNET
Manual pulse generator operation function		Possible to connect 3 modules
Synchronous encoder operation function		Possible to connect 12 modules ^(Note-1) (SV22 use)
SSCNET I/F		5CH
Controllable modules	Q172LX	Up to 4 modules per CPU
	Q172EX	Up to 6 modules per CPU (SV22 use)
	Q173PX	Up to 4 modules per CPU (Incremental synchronous encoder use in SV22) Up to 1 module per CPU (Only manual pulse generator use)
	QX <input type="checkbox"/>	Total : Up to 256 points per CPU
	QY <input type="checkbox"/>	
	QH <input type="checkbox"/>	
	QX <input type="checkbox"/> Y <input type="checkbox"/>	
Q64AD/Q68ADV/Q68ADI/ Q62DA/Q64DA/Q68DAV/ Q68DAI	Up to 1 module per CPU	
Q160		
PLC extensions		Up to 7 base units
5VDC current consumption [A]		1.25
Exterior dimensions [mm(inch)]		H 98(3.86) X W 27.4(1.08) X D 114.3(4.50)
Weight [kg]		0.23

(Note-1) : Up to 12 modules can be used in the sum total with the manual pulse generator.

■ Motion CPU module

Q172CPUN (Up to 8 axes control)



Items		Specifications
Number of control axes		Up to 8 axes
Operation cycle (default)	SV13	0.88ms : 1 to 8 axes
	SV22	0.88ms : 1 to 4 axes 1.77ms : 5 to 8 axes
Servo amplifier		External servo amplifiers are connected via SSCNET
Peripheral I/F		USB/RS-232/SSCNET
Manual pulse generator operation function		Possible to connect 3 modules
Synchronous encoder operation function		Possible to connect 8 modules ^(Note-1) (SV22 use)
SSCNET I/F		2CH
Controllable modules	Q172LX	Up to 1 module per CPU
	Q172EX	Up to 4 modules per CPU (SV22 use)
	Q173PX	Up to 3 modules per CPU (Incremental synchronous encoder use in SV22) Up to 1 module per CPU (Only manual pulse generator use)
	QX <input type="checkbox"/>	Total : Up to 256 points per CPU
	QY <input type="checkbox"/>	
	QH <input type="checkbox"/>	
	QX <input type="checkbox"/> Y <input type="checkbox"/>	
Q64AD/Q68ADV/Q68ADI/ Q62DA/Q64DA/Q68DAV/ Q68DAI	Up to 1 module per CPU	
Q160		
PLC extensions		Up to 7 base units
5VDC current consumption [A]		1.14
Exterior dimensions [mm(inch)]		H98(3.86) X W27.4(1.08) X D114.3(4.50)
Weight [kg]		0.22

(Note-1) : Up to 8 modules can be used in the sum total with the manual pulse generator.

■ Servo external signals interface module

Q172LX



Items		Specifications
Upper stroke limit input, Lower stroke limit input, Stop signal input, Proximity dog/ speed-position switching input	Number of input points	Servo external control signals : 32 points, 8 axes
	Input method	Sink/Source type (Photocoupler)
	Rated input voltage/current	12VDC 2mA, 24VDC 4mA
	Operating voltage range	10.2 to 26.4VDC (Ripple ratio 5% or less)
	ON voltage/current	10VDC or more/2.0mA or more
	OFF voltage/current	1.8VDC or less/0.18mA or less
Response time	Upper/lower stroke limit and STOP signal	1ms (OFF → ON, ON → OFF)
	Proximity dog/speed-position switching signal	0.4ms/0.6ms/1ms (OFF → ON, ON → OFF) ※CPU parameter setting, default 0.4ms
Number of I/O occupying points		32 points (I/O allocation: Intelligent, 32 points)
5VDC current consumption [A]		0.05
Exterior dimensions [mm(inch)]		H98(3.86) X W27.4(1.08) X D90(3.54)
Weight [kg]		0.15

■ Synchronous encoder interface module

Q172EX



Items		Specifications
Serial absolute synchronous encoder input	Number of modules	2 per module
	Applicable encoder	MR-HENC
	Position detection method	Absolute (ABS) data method
	Transmission method	Serial communications (2.5Mbps)
	Back up battery	A6BAT/MR-BAT
Tracking enable input	Number of input points	2 points
	Input method	Sink/Source type (Photocoupler)
	Rated input voltage/current	12VDC 2mA, 24VDC 4mA
	Operating voltage range	10.2 to 26.4VDC (Ripple ratio 5% or less)
	ON voltage/current	10VDC or more/2.0mA or more
	OFF voltage/current	1.8VDC or less/0.18mA or less
Response time		0.4ms/0.6ms/1ms (OFF → ON, ON → OFF) ※CPU parameter setting, default 0.4ms
Number of I/O occupying points		32 points (I/O allocation: Intelligent, 32 points)
5VDC current consumption [A]		0.07
Exterior dimensions [mm(inch)]		H98(3.86) X W27.4(1.08) X D90(3.54)
Weight [kg]		0.15

■ Manual pulse generator interface module

Q173PX



Items		Specifications	
Manual pulse generator/ incremental synchronous encoder input	Number of modules	3 per module	
	Voltage-output/ Open-collector type	High-voltage	3.0 to 5.25VDC
		Low-voltage	0 to 1.0VDC
	Differential-output type	High-voltage	2.0 to 5.25VDC
		Low-voltage	0 to 0.8VDC
	Input frequency	Up to 200kpps (After magnification by 4)	
	Applicable types	Voltage-output/Open-collector type (5VDC), (Recommended product: MR-HDP01) Differential-output type (26LS31 or equivalent)	
	Cable length	Voltage-output/Open-collector type: 10m(32.79ft.) Differential-output type: 30m(98.36ft.)	
Tracking enable input	Number of input points	3 points	
	Input method	Sink/Source type (Photocoupler)	
	Rated input voltage/current	12VDC 2mA, 24VDC 4mA	
	Operating voltage range	10.2 to 26.4VDC (Ripple ratio 5% or less)	
	ON voltage/current	10VDC or more/2.0mA or more	
	OFF voltage/current	1.8VDC or less/0.18mA or less	
Response time		0.4ms/0.6ms/1ms (OFF → ON, ON → OFF) ※CPU parameter setting, default 0.4ms	
Number of I/O occupying points		32 points (I/O allocation: Intelligent, 32 points)	
5VDC current consumption [A]		0.11	
Exterior dimensions [mm(inch)]		H98(3.86) X W27.4(1.08) X D90(3.54)	
Weight [kg]		0.15	

Multiple CPU System

An Innovative Multiple CPU System Providing Advanced Performance and Control.

■ Distribution of control processing

- By distributing such tasks as machine control, communication control, servo control, and information control among multiple processors, CPU load is dramatically reduced, allowing extremely fast and efficient processing of complex applications.
- Various I/O modules are assigned to their respective CPU module and can be used on the same base unit simultaneously.

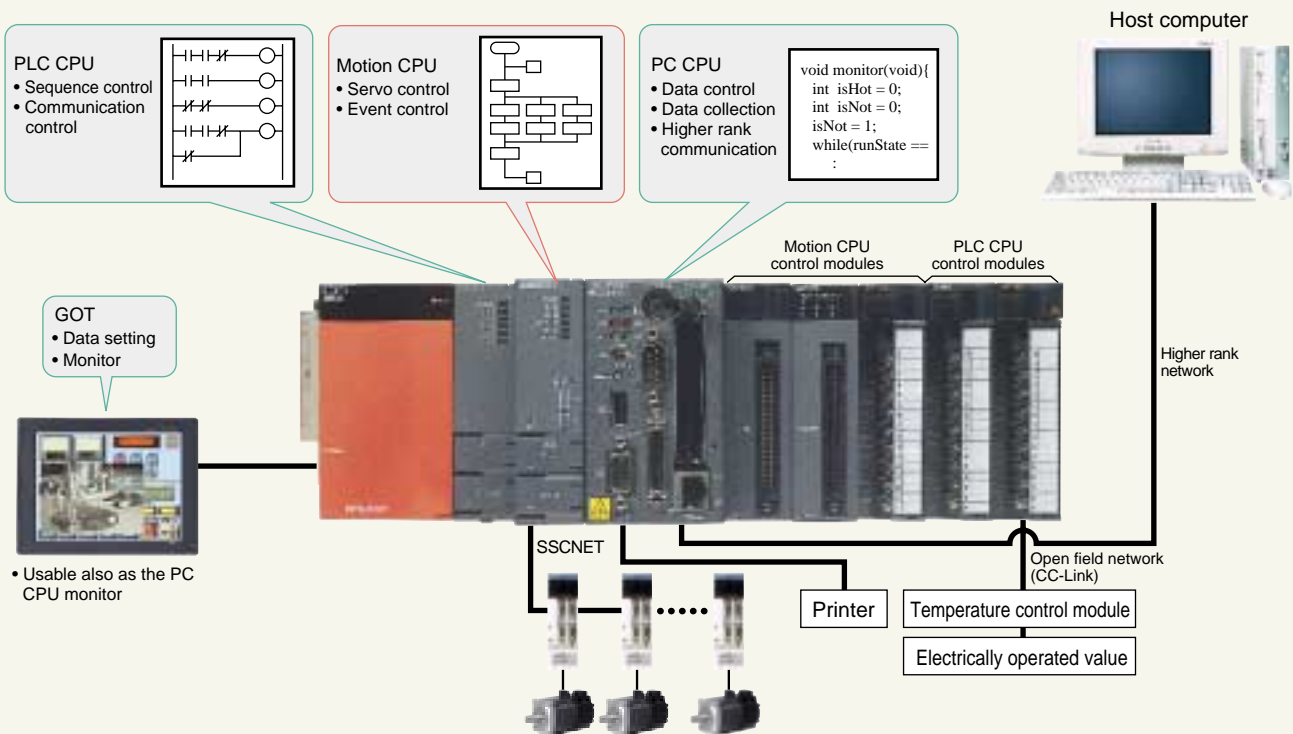

■ Flexible Multiple CPU system configuration

- Multiple CPU configuration allows up to 4 CPU modules to be selected for the systems and control axes.

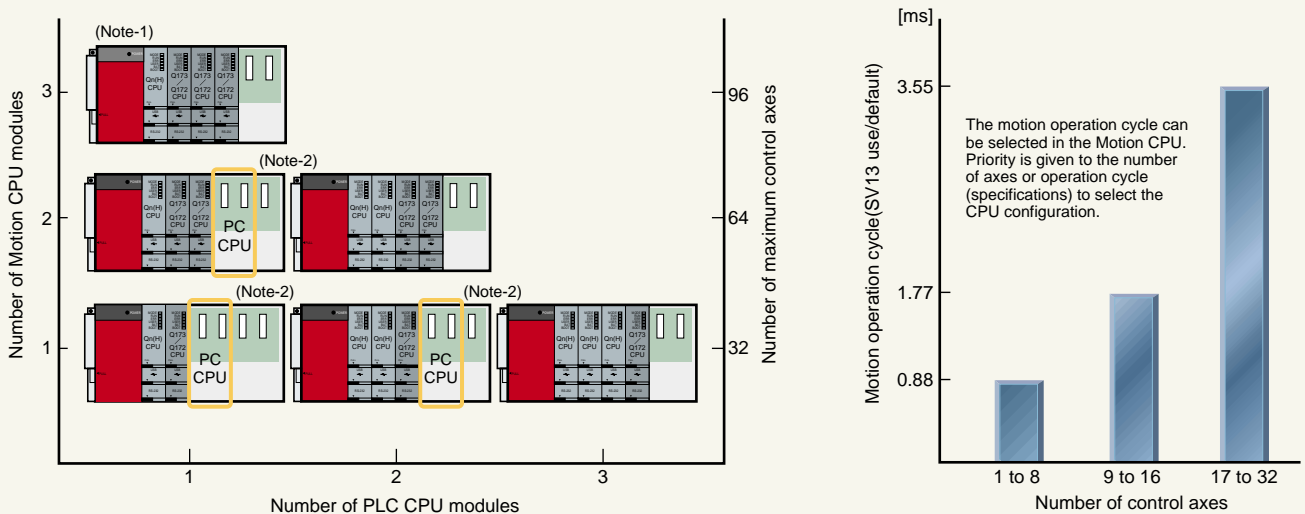

(Note-1) : Be careful of a 5VDC power supply capacity. Select the Q64P (5VDC 8.5A) as required.
 (Note-2) : The PC CPU can be installed to the right-hand side of Motion CPU.

Communication between the Motion CPU and PLC CPU

The optimum functions for your application needs are provided to exchange data between CPU modules.

Communication method	Communication processing timing	Data amount	Function	Application
Automatic refresh	Scan processing	Several hundred words to several kilo words	Data exchange (Area-fixed) (Parameter-fixed)	<p>Regular communication for control device data</p>
Motion dedicated PLC instruction (S(P).DDR, S(P).DDWR)	Direct processing (At the command execution) ※ Interrupt request to the Motion CPU	1 to 16 words	Data exchange (Random access)	<p>Re-writing of the position follow-up control data, etc.</p>
PLC instruction (FROM S(P).TO) Motion SFC instruction (MULTR, MULTW)	Direct processing (At the command execution)	1 to 256 words	Data exchange (Shared memory batch)	<p>Batch data communication</p>
Motion dedicated PLC instruction (S(P).SFCS, S(P).GINT, S(P).SVST, S(P).CHGA, S(P).CHGV, S(P).CHGT)	Direct processing (At the command execution) ※ Interrupt request to the Motion CPU	-	Execution of Motion SFC program/ Event task/ Servo program/ Current value change/ Speed change/ Torque limit value change/	<p>Program start, event execute control</p>

Access to the other CPU via USB/RS-232 connecting

Access to the Motion CPU and PLC CPU on the same base unit is possible using one personal computer.

The programming/monitor of other CPU modules on the same base unit is possible, by only connecting a personal computer installed the programming software to one CPU module. A personal computer can also be connected with each CPU module.

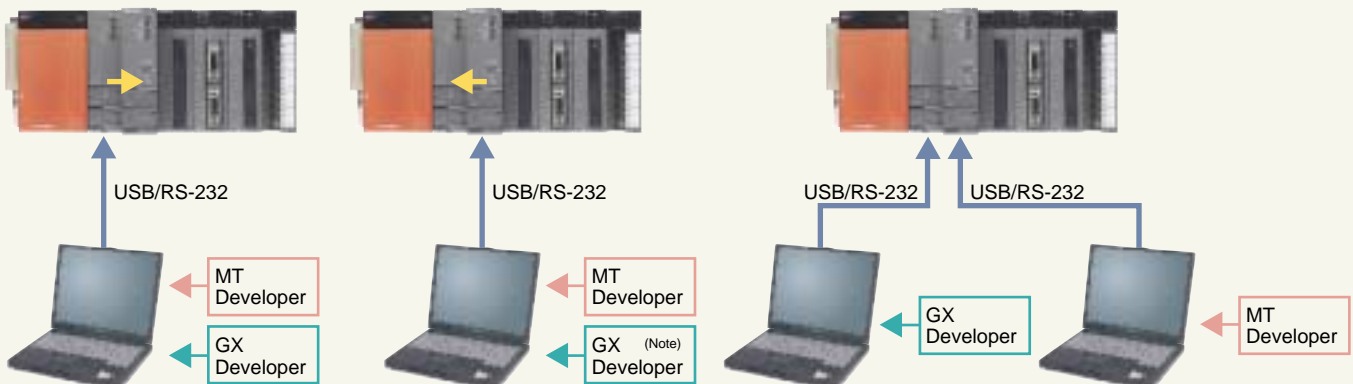

(Note) Use the Version 6.05F or later.

Motion SFC Program

Powerful Programming Environment with Event Processing.

- The Motion control program is described in flowchart form using the Motion SFC (Sequential Function Chart) format. By describing the Motion CPU program using the suitable Motion SFC function blocks, the Motion CPU can control the machine operation and aid in the event processing.
- Easy programming for the entire system operation is possible by using the available icons such as **[F]** (Arithmetic Operation, I/O Control), **[G]** (Transition Conditional Judgement) and **[K]** (Motion Control) arranged in a sequential process.

■ Motion SFC description

Flowchart description are easy to read and understand

- The machine operation procedure can be visualized in the program by using the flowchart descriptions.
- A process control program can be created easily, and control details can be visualized.

A logical layered structure program

- Operation commands are easily described by creating comments.
- Operation commands are detailed in a step by step format in a layered structure program.

Controlling sequential machine operation using the Motion CPU

- Servo control, I/O control, and operation commands can be combined in the Motion SFC program.
- Servo control can be accomplished without the need for a PLC program.

Enhanced operation functions

- Commands can be described with arithmetic and logic operation expressions.
- Compatible with 64-bit floating-point operations.
- Arithmetic functions include trigonometric functions, square root, natural logarithm, etc.

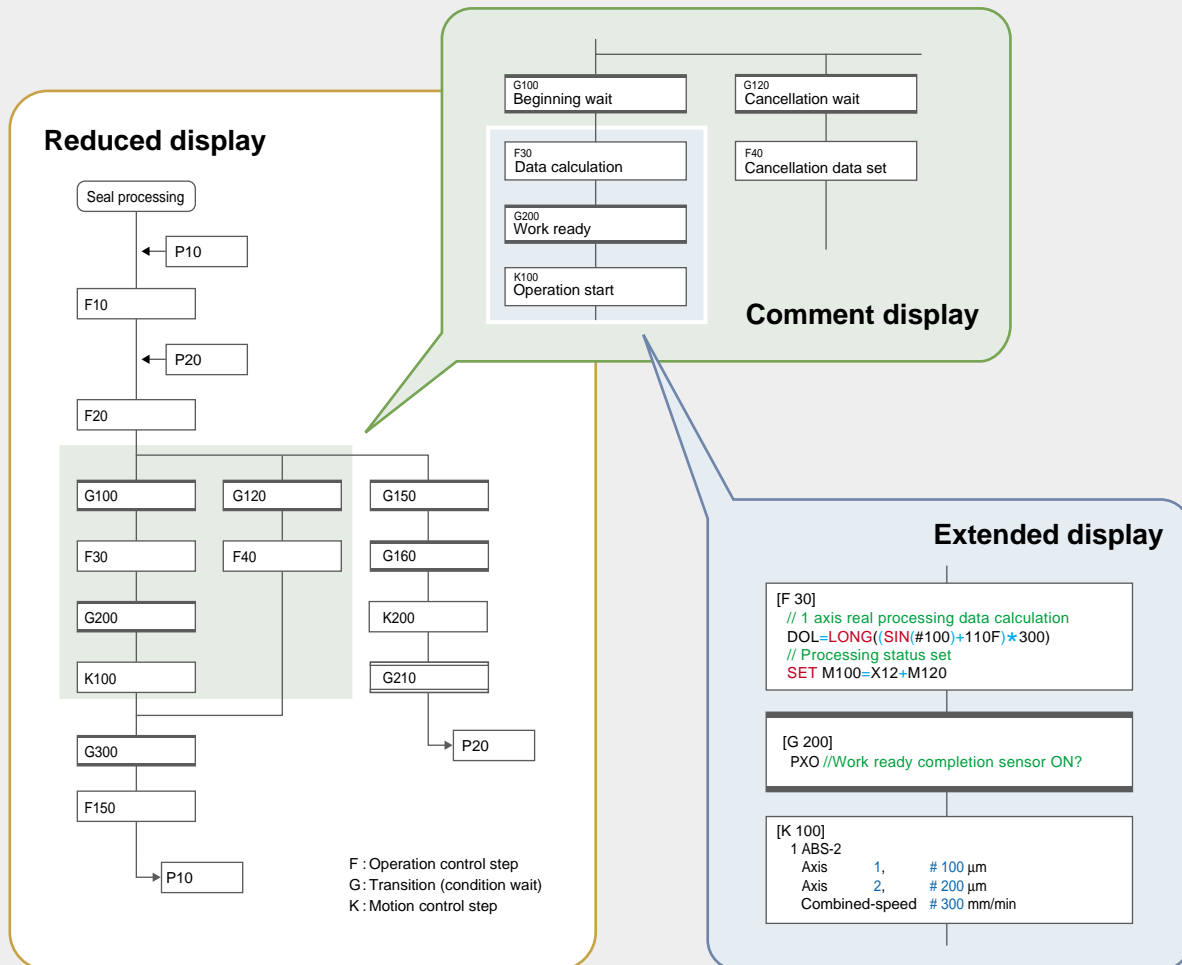

Multiple CPU control using PLC CPU and Motion CPU

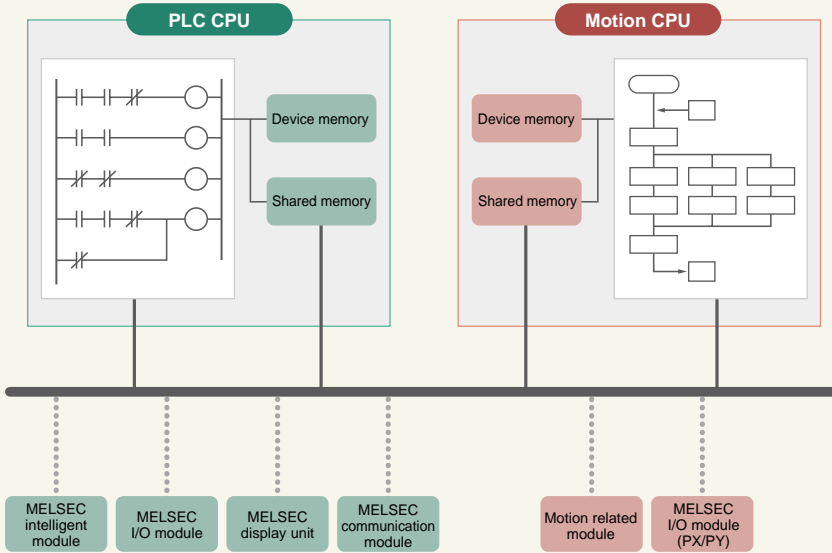

By distributing such tasks as servo control, machine control, and information control among multiple processors, the flexible system configuration can be realized. The program of Motion CPU is described in the Motion SFC program.

Event processing

The high-speed response (control for the signal output, servomotor start, speed change, etc.) is executed by waiting for the condition completion (event occurrence) according to the change of input signal state and device value change in this processing.

- Event examples**
- Input signal turned on
 - Operation results reached constant-value
 - Constant-time passed
 - Positioning completed

Ladder description suitable for scan process
(Importance laid on condition control)

- Sequence control (Compatible with multiple I/O points, multiple operations)
- System stop processing at error detection

Motion SFC description suitable for event process
(Importance laid on sequential control, pursuit of event responsiveness)

- Servo high-speed response (Start)
- Positioning address, speed data operation, speed change
- High functionality with multitasking and branching

Control flow

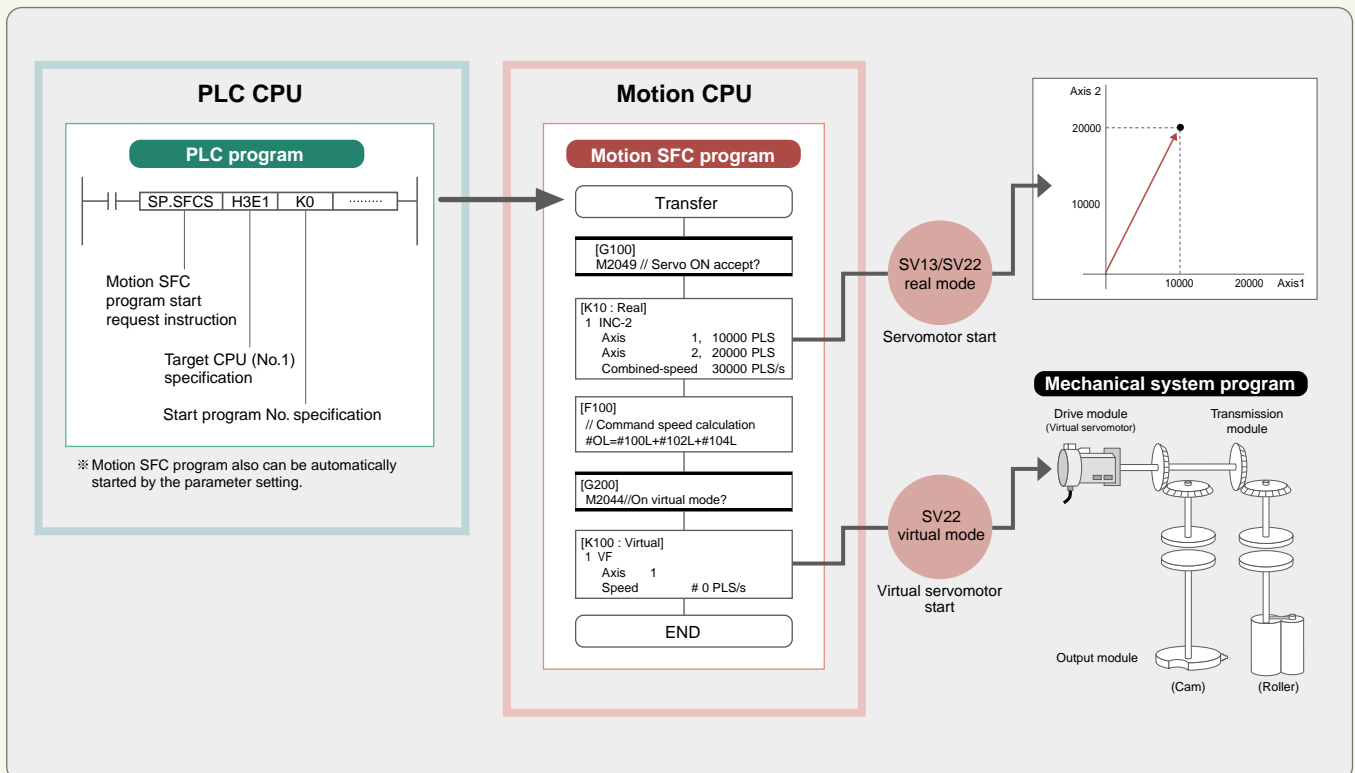

Motion SFC Program

Motion SFC operation

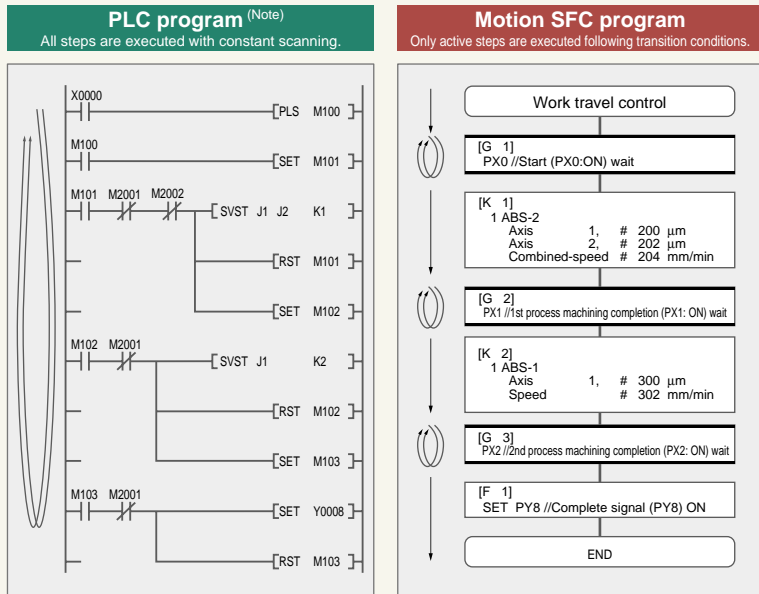

High-speed response using step execute method

■ The PLC program uses a scan execute method to execute all steps with constant scanning. However, since the step execute method which executes only the active steps following the transition conditions is used in the Motion SFC program, the operation processing can be reduced, and processing or response control can be realized.

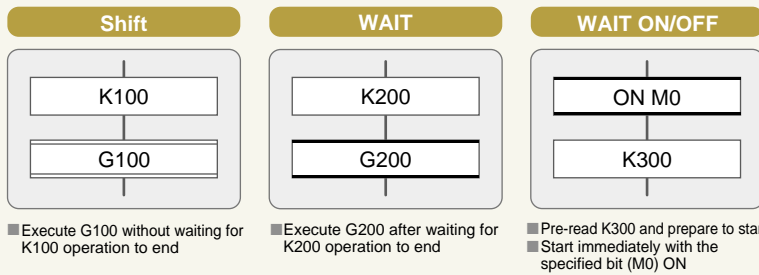

Dedicated description unique to motion control

- If shift is executed immediately after the motion control step, the shift is executed without waiting for the motion control operation to end.
- If WAIT is executed immediately after the motion control step, WAIT will be executed after waiting for the motion control operation to end.
- If WAIT ON/WAIT OFF is executed just before the motion control step, the details of the motion control will be pre-read, and preparations for start are made. The operation starts immediately with the specified bit device ON/OFF.

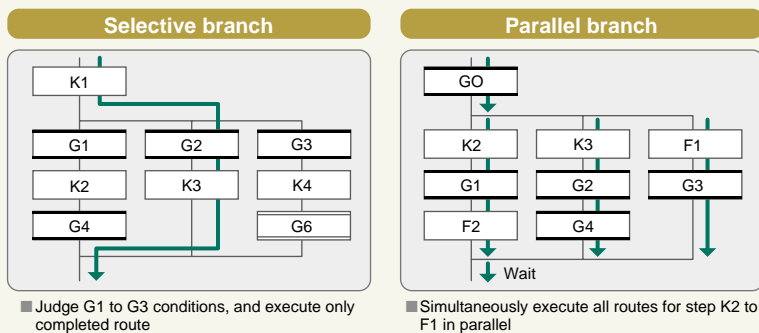

Selective branch and parallel branch

- When all routes after branch are shift or WAIT, selective branch is used. Parallel branch is used in all other cases.
- The route for which the transition conditions are completed first are executed in the selective branch.
- The routes connected in parallel are executed simultaneously, the processing waits at the connection point, and shifts to the next process after execution of all routes is completed in the parallel branch.

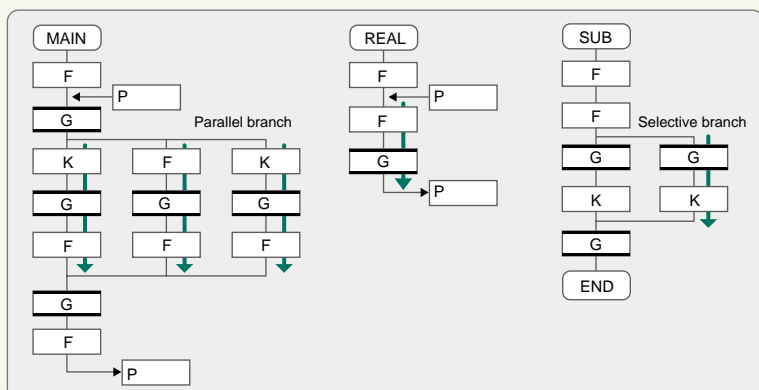

Multi-task processing

- When the multiple programs are started, the processing is executed with multi-task operation in the Motion SFC program.
- Multiple steps can be simultaneously executed with parallel branching even in one program.
- A program that executes the multiple processing simultaneously or makes the independent movement by grouping the control axes can be created easily.
- A highly independent programming is possible according to the processing details, so a simple program can be created.

Task operation examples of Motion SFC program

Normal task

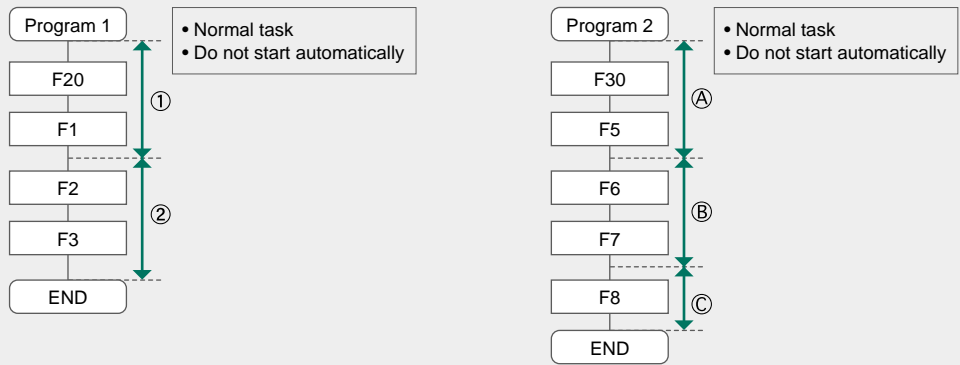

Timing chart

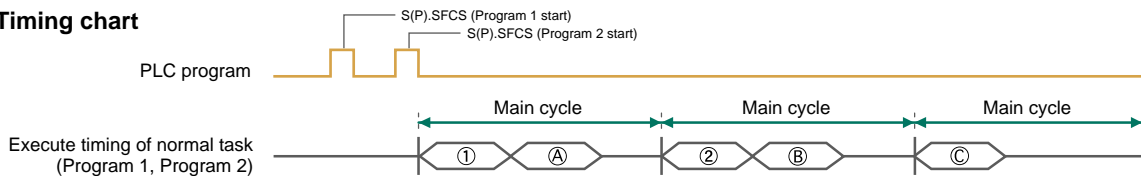

Event task/NMI task

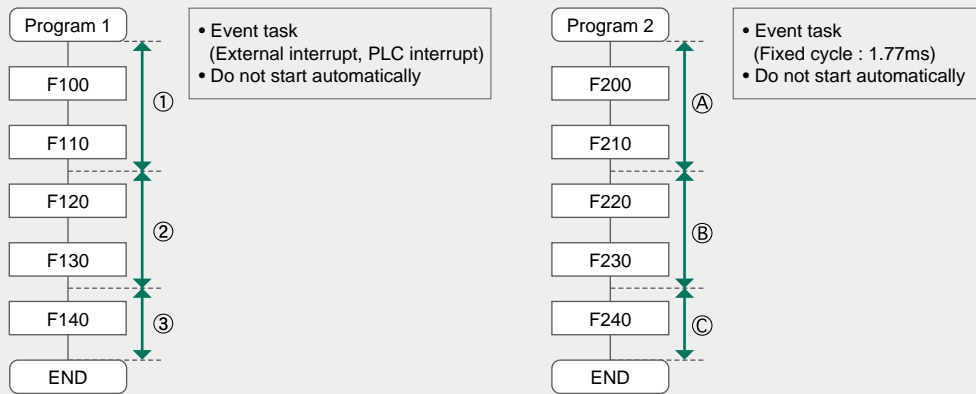

Timing chart

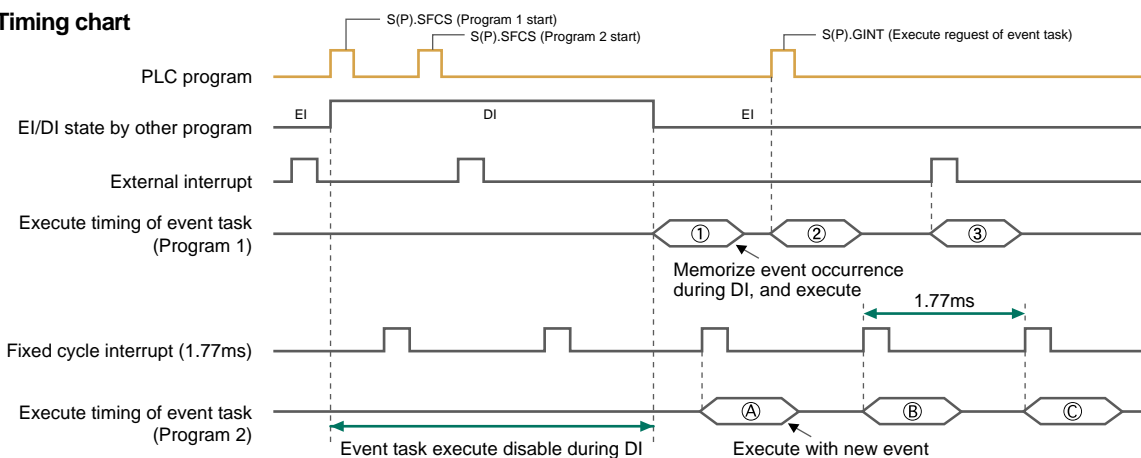

(Note): Number of steps executed in 1 time of processing cycle are set in the parameters.

Motion SFC Program

■ Various programming tools in a effective background on Windows



Integrated start-up support software MT Developer

System design

System setting

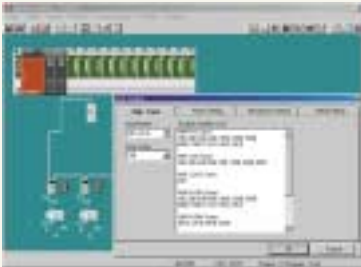

- Set the system configuration (Motion module, servo amplifier, servomotor) with menu selection

Servo data setting



- Set the servo parameter or fixed parameter, etc.
- Display explanations of parameters with one-point help

Programming

Motion SFC program editing



- Describe machine operation procedures with flow chart format
- Lay out graphic symbols by clicking mouse and connect by dragging

Program editing

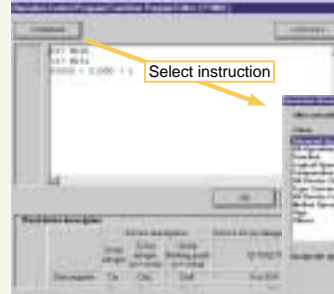

Select instruction

Instruction wizard

- Program for each step and transition
- Selection with menu is also possible using command wizard

Motion SFC monitor



- Color display of executing step on flow chart
- Device monitor and test of execution/specification

Motion SFC debugging mode

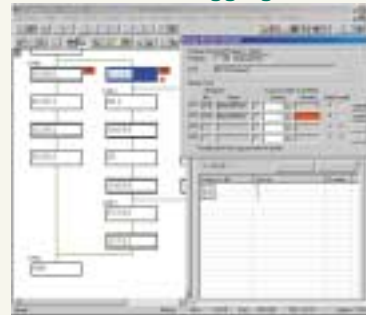

- Greatly reduced debugging time with powerful debug function (One-step execution/Forced shift/Brake/Forced end)

Start-up adjustment

Monitor • Test

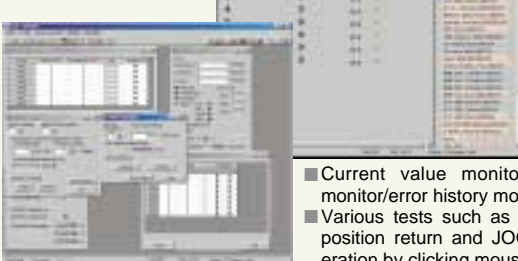

- Current value monitor/axis monitor/error history monitor
- Various tests such as home position return and JOG operation by clicking mouse

Digital oscilloscope

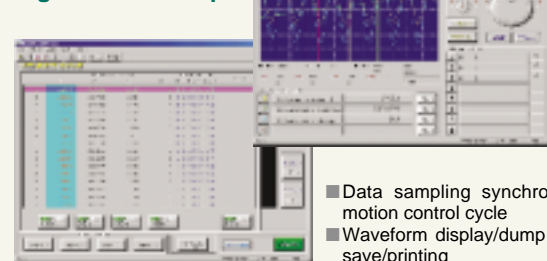

- Data sampling synchronized with motion control cycle
- Waveform display/dump display/file save/printing

Integrated start-up support software MT Developer

Software	Function	
Conveyor assembly software SW6RN-GSV13P Automatic machinery software SW6RN-GSV22P	Installation	<ul style="list-style-type: none"> • Installation of operating system (OS) • Comparison of operating system (OS)
	Project management	<ul style="list-style-type: none"> • New creation, setting and reading of projects • Batch management of user files in project units
	System setting	<ul style="list-style-type: none"> • Setting of system configuration (Motion module, servo amplifier or servomotor, etc.) • Setting of high-speed reading data
	Servo data setting	<ul style="list-style-type: none"> • Setting of servo parameters or fixed parameters, etc. (Display explanation with one-point help) • Setting of limit switch output data (Output pattern display with waveform display function)
	Program editing	<ul style="list-style-type: none"> • Editing of Motion SFC program/Setting of Motion SFC parameters • Reduced display, comment display and extended display of Motion SFC chart • Motion SFC monitor/Motion SFC debug
	Mechanical system editing (GSV22P only)	<ul style="list-style-type: none"> • Editing of mechanical system program • Monitoring of mechanical system program execute state
	Communication	<ul style="list-style-type: none"> • Setting of SSCNET communication CH/Communication setting between USB and RS-232 • Writing, reading and comparison of programs and parameters for Motion controller
	Monitoring	<ul style="list-style-type: none"> • Current value monitor/Axis monitor/Error history monitor • Servo monitor/Limit switch output monitor
	Test	<ul style="list-style-type: none"> • Servo startup/Servo diagnosis • Jog operation/Manual pulser operation/Home position return test/Program operation • Teaching/Error reset/Current value change
	Backup	<ul style="list-style-type: none"> • Backup of Motion controller programs and parameters in file • Batch writing of backed up files to Motion CPU
Cam data creation software SW3RN-CAMP	Cam data creation	<ul style="list-style-type: none"> • Cam data creation with Cam pattern selection and free curve settings • Graphic display of Cam control state
Digital oscilloscope software SW6RN-DOSCP	Digital oscilloscope	<ul style="list-style-type: none"> • Data sampling synchronized to operation cycle • Waveform display, dump display and file saving of collected data
Communication system software SW6RN-SNETP	Communication system Communication API	<ul style="list-style-type: none"> • Communication task/Communication manager/Common memory server/SSCNET communication driver • Support of cyclic communication, transient communication, high-speed refresh communication • Communication API functions compatible with VC++/VB
Document printing software SW3RN-DOCPRNP (Note-1) SW20RN-DOCPRNP (Note-2)	Printing	<ul style="list-style-type: none"> • Printing of programs, parameters and system settings (Convert into Word 97, Excel 97 or Word 2000 and Excel 2000 document format, and print)

(Note-1) : Word 97 and Excel 97 are required.
 (Note-2) : Word 2000 and Excel 2000 are required.

Operating environment

IBM PC/AT with which WindowsNT4.0/98/2000/XP English version operated normally.

Item	WindowsNT [®] 4.0 (Service Pack 2 or later) or Windows [®] 98	Windows [®] 2000	Windows [®] XP
CPU	Recommended Pentium [®] 133MHz or more	Recommended Pentium [®] II 233MHz or more	Recommended Pentium [®] II 450MHz or more
Memory capacity	Recommended 32MB or more	Recommended 64MB or more	Recommended 192MB or more
Hard disk free space	SW6RNC-GSVE: 160MB + SW6RNC-GSVHELPE: 85MB (Possible to select installation)		
Display	SVGA (Resolution 800 X 600 pixels, 256 colors) or more		
Application software	Word 97, Excel 97 or Word 2000, Excel 2000 (For document printing) Visual C++ 4.0 or more, Visual Basic 4.03 (32 bit) or more (For communication API function)		

(Note) • When using the A30CD-PCF, the PC card driver for WindowsNT[®] provided by the personal computer manufacturer must be used.
 • WindowsNT[®], Windows[®], Word, Excel, Visual C++ and Visual Basic are either registered trademarks or trademarks of Microsoft Corporation in the United States and/or other countries.
 • Pentium[®] is trademarks or registered trademarks of Intel Corporation or its subsidiaries in the United States and other countries.

Motion SFC Program

■ Motion SFC high-speed response control

High-speed response to external inputs

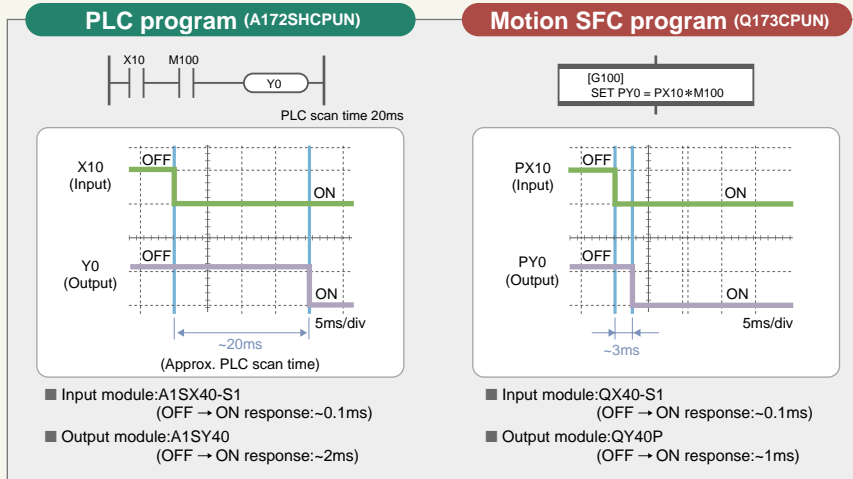

I/O output

- The response time of output signal for the input signal from an external source is measured in this program.
- The response time and dispersion affected by the scan time are approx. 20ms in the PLC program of A172SHCPUN.
- The response time and dispersion are approx. 3ms in the Motion SFC program.

Powerful reduction in servo program start time

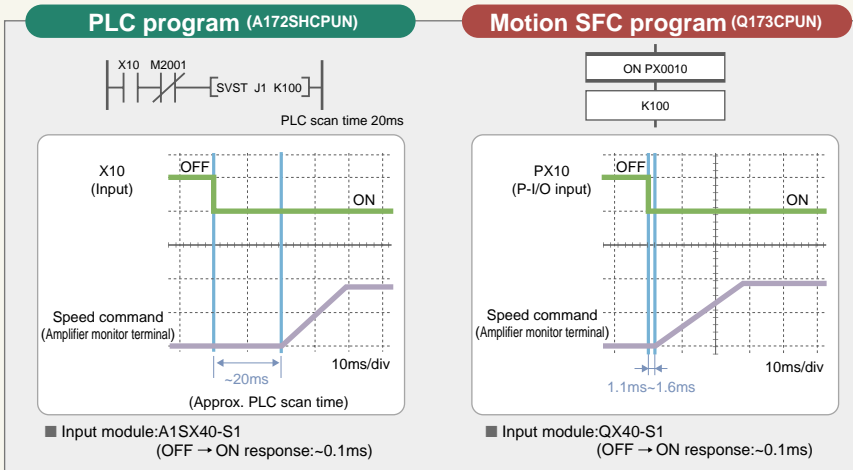

Servo program start

- The servo program is started using the input signal from an external source as a trigger in this example.
- The response time and dispersion are affected by the scan time from the external signal input to starting of speed command is approx. 20ms in the start using the PLC program of A172SHCPUN.
- The speed command is started with the response time "2 ms or less" and dispersion "approx. 0.5ms" in the Motion SFC program.

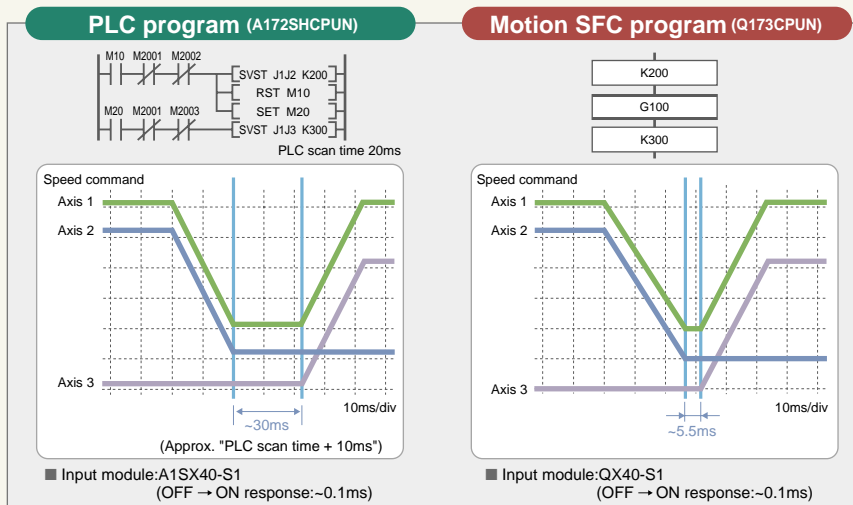

Servo program continuous start

- 1 axis, 3 axes linear interpolation program "K200" is started following 1 axis, 2 axes linear interpolation program "K300" in this example.
- The response time and dispersion are approx. 30ms in the servo program continuous start using the PLC program of A172SHCPUN. This is because the PLC scan time is 20ms, and the refresh cycle of start accept flag M2000 used as the interlock is 10ms.
- An interlock is not required and the start delay is approx. 5.5 in the Motion SFC program.

Motion SFC specifications

Motion SFC chart symbols

Class	Name	Symbol	Function
Program start/end	START		Indicates the program start (entrance) .
	END		Indicates the program end (exit) .
Step	Motion control step		Starts the servo program Kn. (Refer to page 20 for the servo instructions.)
	Once execution type operation control step		Executes the operation control program Fn once.
	Scan execution type operation control step		Repeats an operation control program FSn until the completion of next transition condition.
	Subroutine call/start step		Calls or starts a subroutine.
	Clear step		Cancels and ends the execution of specified program.
Transition	Shift (Pre-read transition)		Shifts to the next step with the completion of condition without waiting for the previous motion control step or subroutine to end.
	WAIT		Shifts to the next step with the completion of condition after the previous motion control step or subroutine end.
	WAIT ON		Prepares to start the next motion control step, and immediately commands the completion of condition.
	WAIT OFF		
Jump	Jump		Jumps to the specified pointer Pn of the self program.
Pointer	Pointer		Indicates the jump destination pointer (label).

Motion SFC program parameters

The Motion SFC program start method and execute timing are set with the program parameters.

Item	Setting range	Details	
Start setting	Start automatically	• Starts at the turning PLC ready (M2000) off to on.	
	Do not start automatically	• Starts with the Motion SFC program start instruction $[S(P).SFCS]$. • Starts with the "Subroutine call/start" $[GSUB]$ from the Motion SFC program.	
Execute task	Normal task	• Executes in the motion main cycle (free time).	
	Event task	Fixed cycle	• Executes in the fixed cycle (0.88ms, 1.77ms, 3.55ms, 7.11ms, 14.2ms).
		External interrupt	• Executes when input ON is set among the interrupt module (QI60 16 points).
		PLC interrupt	• Executes with interrupt from PLC (PLC dedicated instruction $[S(P).GINT]$ is executed.).
NMI task	• Executes when input ON is set among the interrupt module (QI60 : 16 points).		

Operation control steps and transition commands

Class	Symbol	Function
Binary operation	=	Substitution
	+	Addition
	-	Subtraction
	*	Multiplication
	/	Division
	%	Remainder
Bit operation	~	Bit inversion (complement)
	&	Bit logical AND
		Bit logical OR
	^	Bit exclusive OR
	>>	Bit right shift
	<<	Bit left shift
Sign	-	Sign inversion (complement of 2)
Type conversion	SHORT	Convert into 16-bit integer type (signed)
	USHORT	Convert into 16-bit integer type (unsigned)
	LONG	Convert into 32-bit integer type (signed)
	ULONG	Convert into 32-bit integer type (unsigned)
	FLOAT	Regarded as signed data, and convert into 64-bit floating point type
	UFLOAT	Regarded as unsigned data, and convert into 64-bit floating point type

Class	Symbol	Function
Standard function	SIN	Sine
	COS	Cosine
	TAN	Tangent
	ASIN	Arcsine
	ACOS	Arccosine
	ATAN	Arctangent
	SQRT	Square root
	LN	Natural logarithm
	EXP	Exponential operation
	ABS	Absolute value
	RND	Round off
	FIX	Round down
	FUP	Round up
	BIN	BCD → BIN conversion
	BCD	BIN → BCD conversion
	Bit device status	(none)
!		OFF (normally closed contact)
Bit device control	SET	Device set
	RST	Device reset
	DOUT	Device output
	DIN	Device input
OUT	Bit device output	

Class	Symbol	Function
Logical operation	(none)	Logical acknowledgement
	!	Logical negation
	*	Logical AND
Comparison operation	+	Logical OR
	==	Equal to
	!=	Not equal to
	<	Less than
	<=	Less than or equal to
Motion dedicated function	>	More than
	>=	More than or equal to
	CHGV	Speed change request
	CHGT	Torque limit value change request
Others	EI	Event task enable
	DI	Event task disable
	NOP	No operation
	BMOV	Block move
	TIME	Time to wait
	MULTW	Write device data to shared CPU memory
	MULTR	Read device data from shared CPU memory of the other CPU
	TO	Write device data to intelligent/special function module
	FROM	Read device data from intelligent/special function module

Motion dedicated PLC instructions

Instructions	Control details
S(P).SFCS	Requests to start the specified Motion SFC program.
S(P).GINT	Requests to start the event task of Motion SFC program.
S(P).SVST	Requests to start the specified servo program.
S(P).CHGA	Amends the current value of specified axes.
S(P).CHGV	Amends the speed of specified axes.
S(P).CHGT	Amends the torque control value of specified axes.
S(P).DDRW	Writes the PLC CPU device data to the Motion CPU devices.
S(P).DDRDR	Reads the PLC CPU device data to the Motion CPU devices.

Motion SFC Program

Example of Motion SFC program

This is a control example of assortment equipment which judges 3 types work and performs assortment conveyance on 3 lines.

Machine composition

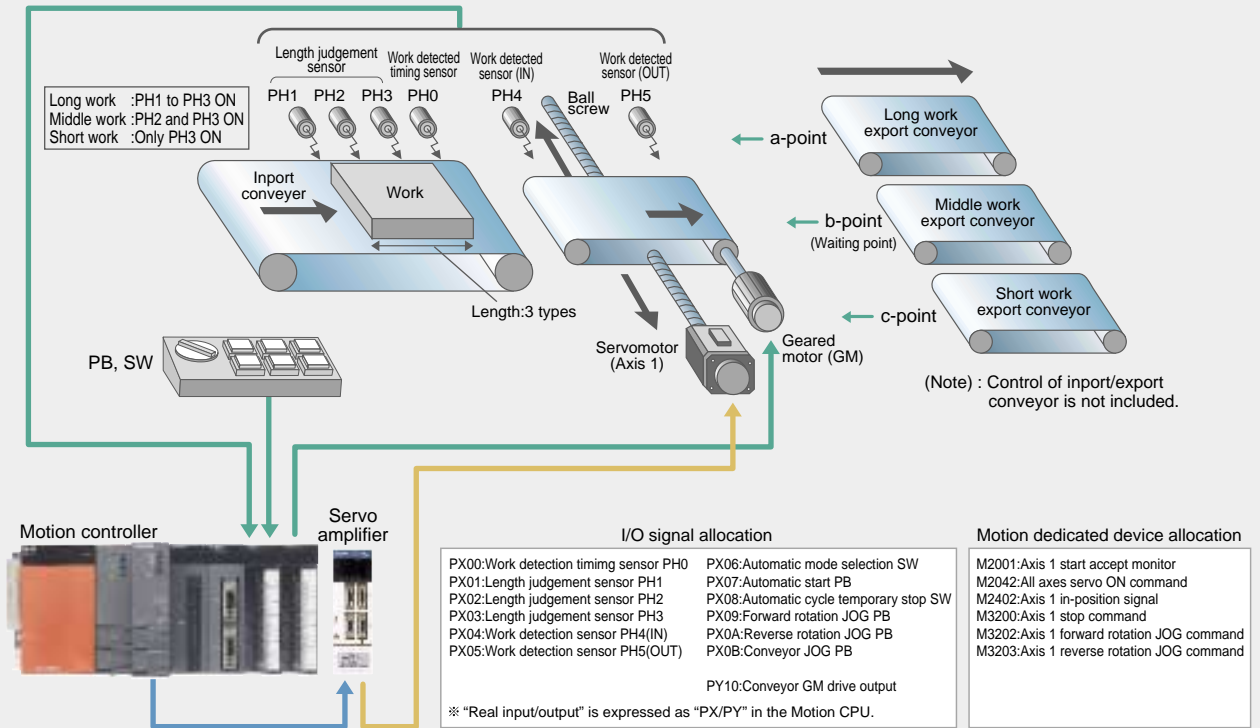

Timing chart of automatic operation

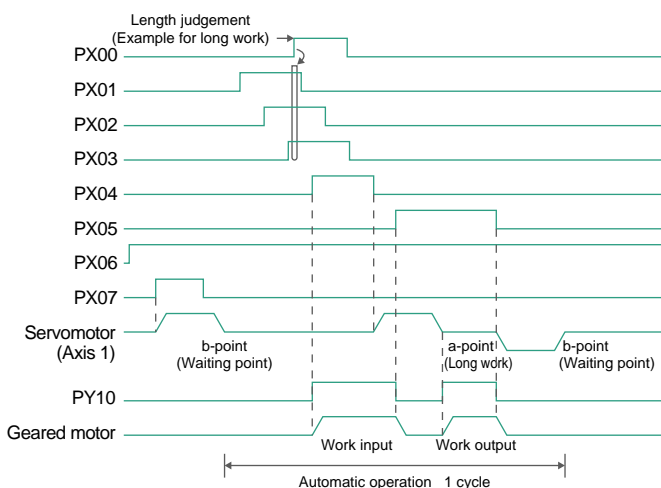

Operation specifications

- Automatic operation mode is set by turning the automatic mode selection SW (PX06) ON, and manual operation mode is set by OFF.
- Manual operation mode
 - JOG operation of servomotor is executed with the forward rotation JOG (PX09)/reverse rotation JOG (PX0A).
 - JOG operation (export direction only) of geared motor is executed with the conveyor JOG PB (PX0B).
- Manual operation mode
 - Automatic operation cycle (assortment conveyance) shown in a chart is started by turning the automatic start PB (PX07) ON.
 - Automatic operation cycle is stopped temporarily by turning the automatic cycle temporary stop SW (PX08) ON, and it is resumed by OFF.
 - Automatic operation cycle is stopped by turning the automatic mode selection SW (PX06) OFF, and it shifts to the manual operation mode.

Main Motion SFC program

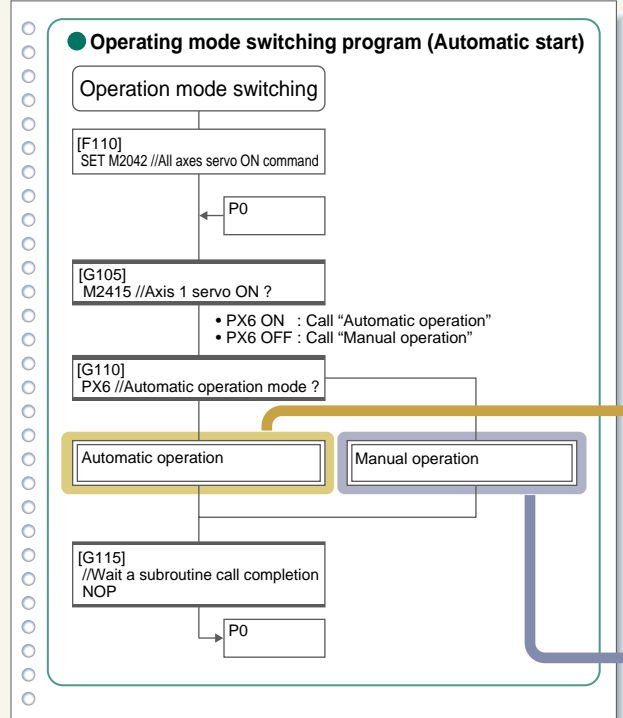

Sub Motion SFC program

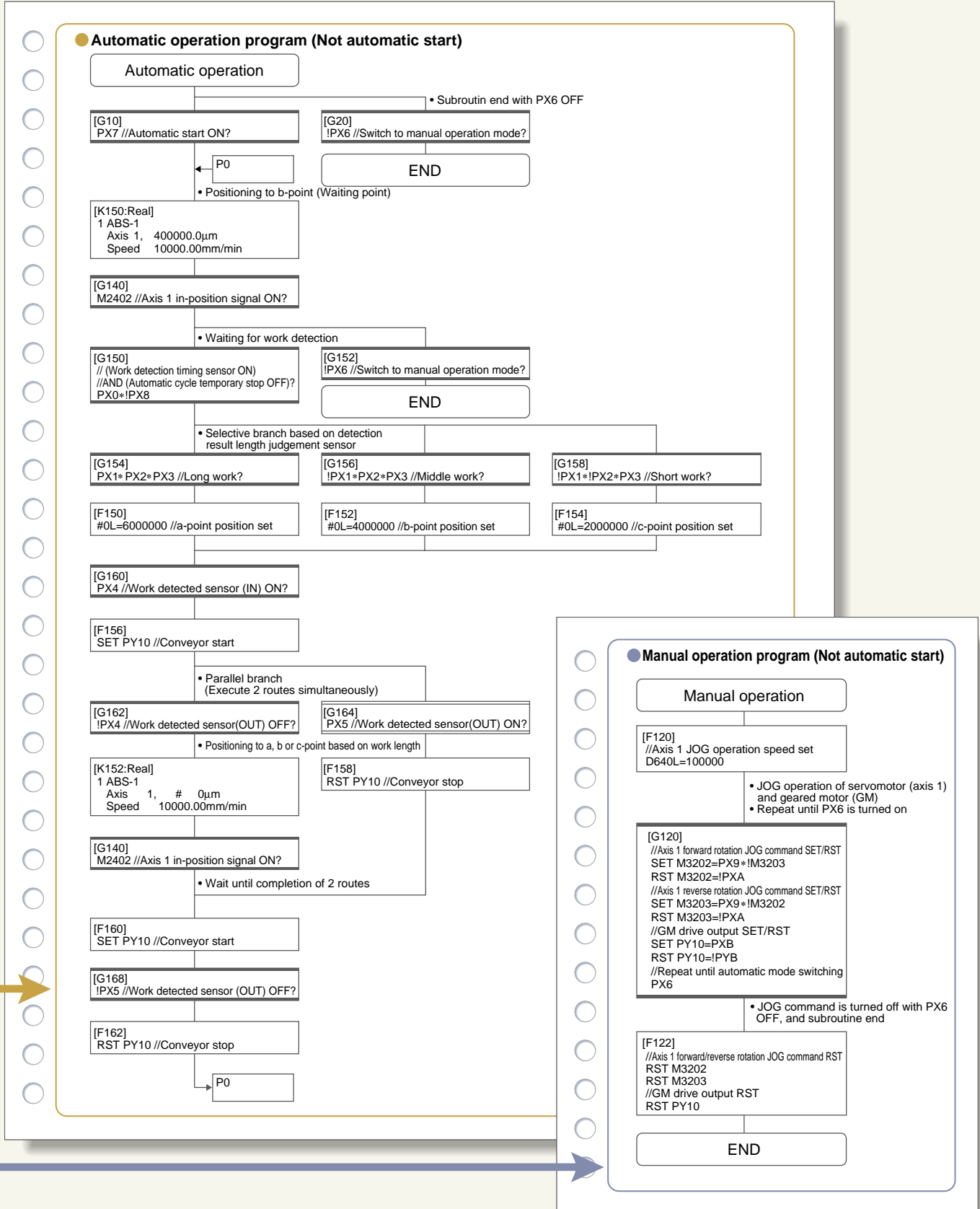

SV13 (Conveyor Assembly Use)







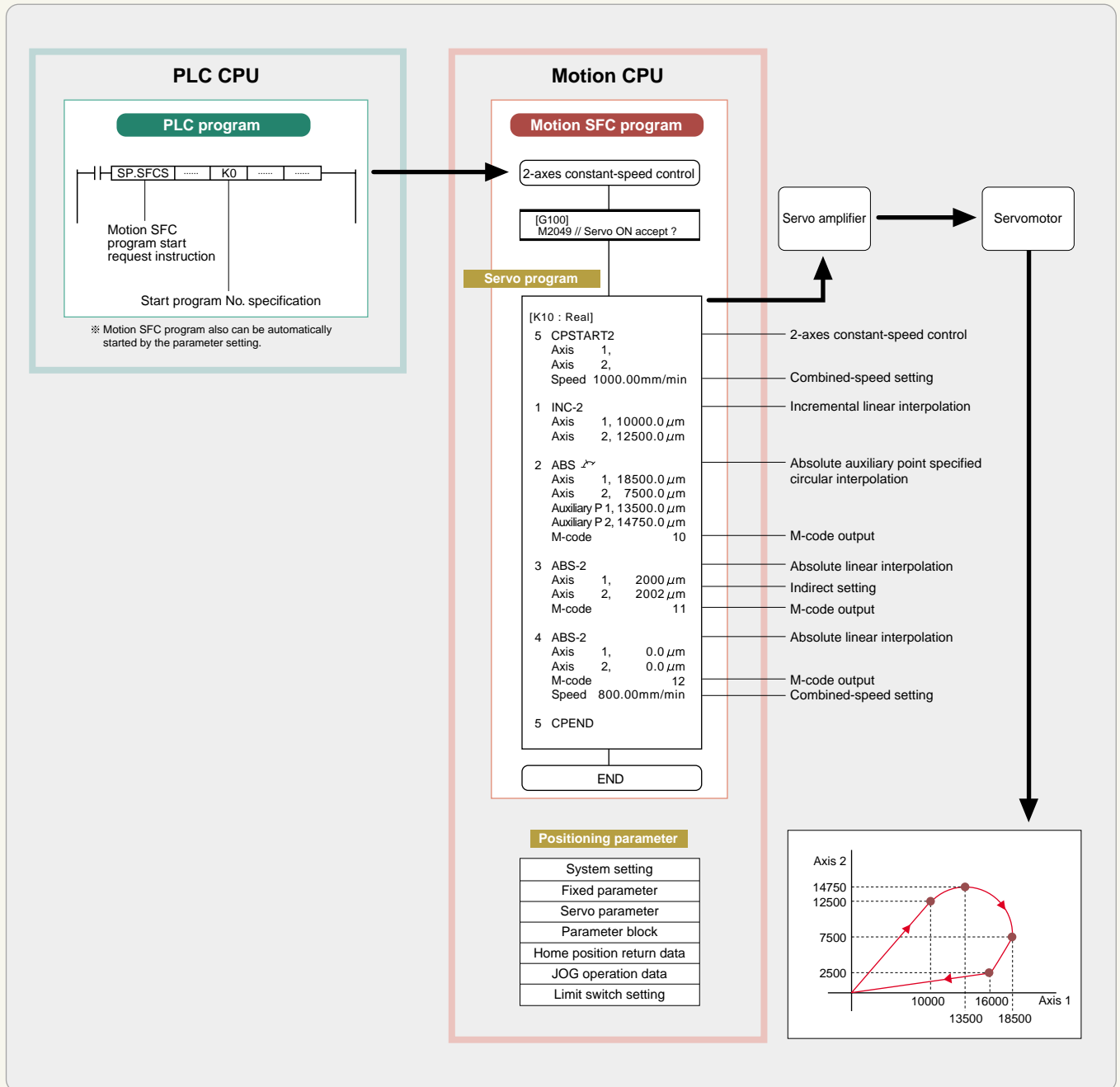







Simple Programming Using Dedicated Instructions.















■ Colorful positioning controls and locus controls such as “1 to 4 axes linear interpolation, 2 axes circular interpolation, helical interpolation, positioning control, speed control or constant-speed control” are supported. Particularly simple programming for positioning systems is attained by using dedicated servo and PLC instructions. A variety of enhanced functions allow easy programming of conventionally complex systems.

Control flow



Servo instructions

Positioning control	Instruction symbol	Processing	
Linear interpolation control	1 axis	ABS-1 Absolute 1-axis positioning	
		INC-1 Incremental 1-axis positioning	
	2 axes	ABS-2 Absolute 2-axes linear interpolation	
		INC-2 Incremental 2-axes linear interpolation	
	3 axes	ABS-3 Absolute 3-axes linear interpolation	
		INC-3 Incremental 3-axes linear interpolation	
	4 axes	ABS-4 Absolute 4-axes linear interpolation	
		INC-4 Incremental 4-axes linear interpolation	
Circular interpolation control	Auxiliary point-specified	ABS  Absolute auxiliary point-specified circular interpolation	
		INC  Incremental auxiliary point-specified circular interpolation	
	Radius-specified	ABS  Absolute radius-specified circular interpolation less than CW 180°	
		ABS  Absolute radius-specified circular interpolation CW 180° or more	
		ABS  Absolute radius-specified circular interpolation less than CCW 180°	
		ABS  Absolute radius-specified circular interpolation CCW 180° or more	
		INC  Incremental radius-specified circular interpolation less than CW 180°	
		INC  Incremental radius-specified circular interpolation CW 180° or more	
		INC  Incremental radius-specified circular interpolation less than CCW 180°	
		INC  Incremental radius-specified circular interpolation CCW 180° or more	
		Central point-specified	ABS  Absolute central point-specified circular interpolation CW
			ABS  Absolute central point-specified circular interpolation CCW
	INC  Incremental central point-specified circular interpolation CW		
	INC  Incremental central point-specified circular interpolation CCW		

Positioning control	Instruction symbol	Processing	
Helical interpolation control	Auxiliary point-specified	ABH  Absolute auxiliary point-specified helical interpolation	
		INH  Incremental auxiliary point-specified helical interpolation	
	Radius-specified	ABH  Absolute radius-specified helical interpolation less than CW 180°	
		ABH  Absolute radius-specified helical interpolation CW 180° or more	
		ABH  Absolute radius-specified helical interpolation less than CCW 180°	
		ABH  Absolute radius-specified helical interpolation CCW 180° or more	
		INH  Incremental radius-specified helical interpolation less than CW 180°	
		INH  Incremental radius-specified helical interpolation CW 180° or more	
		INH  Incremental radius-specified helical interpolation less than CCW 180°	
		INH  Incremental radius-specified helical interpolation CCW 180° or more	
		Central point-specified	ABH  Absolute central point-specified helical interpolation CW
			ABH  Absolute central point-specified helical interpolation CCW
	INH  Incremental central point-specified helical interpolation CW		
	INH  Incremental central point-specified helical interpolation CCW		

Positioning control	Instruction symbol	Processing
Fixed-pitch feed	FEED-1 1 axis	1-axis fixed-pitch feed start
	FEED-2 2 axes	2-axes linear interpolation fixed-pitch feed start
	FEED-3 3 axes	3-axes linear interpolation fixed-pitch feed start
Speed control (I)	VF	Speed control (I) forward rotation start
	VR	Speed control (I) reverse rotation start
Speed control (II)	VVF	Speed control (II) forward rotation start
	VVR	Speed control (II) reverse rotation start
Speed-position control	VPF	Speed-position control forward rotation start
	VPR	Speed-position control reverse rotation start
Reset	VPSTART	Speed-position control restart
	Speed switching control	VSTART
VEND		Speed switching control end
VABS		Speed switching point absolute specification
VINC		Speed switching point incremental specification
Position follow-up control	PFSTART	Position follow-up control start
Constant-speed control	CPSTART1	1-axis constant-speed control start
	CPSTART2	2-axes constant-speed control start
	CPSTART3	3-axes constant-speed control start
	CPSTART4	4-axes constant-speed control start
	CPEND	Constant-speed control end
Repetition of same control (used in speed switching control, constant-speed control)	FOR-TIMES	Repeat range start setting
	FOR-ON	
	FOR-OFF	Repeat range end setting
Simultaneous start	START	Simultaneous start
Home position return	ZERO	Home position return start
High-speed oscillation	OSC	High-speed oscillation start
Current value change	Servo	CHGA Servo/virtual servo current value change
	Encoder	CHGA-E Encoder current value change
	CAM	CHGA-C CAM shaft current value change

SV13 (Conveyor Assembly Use)

Application examples

X-Y table

- 2-axes linear interpolation
- 3-axes linear interpolation
- 2-axes circular interpolation
- Constant-speed locus control

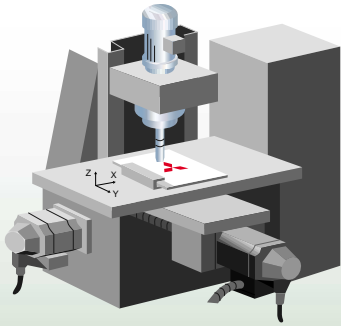

Sealing

- Constant-speed locus control
- Linear, circular interpolation
- High speed, high-precision locus operation

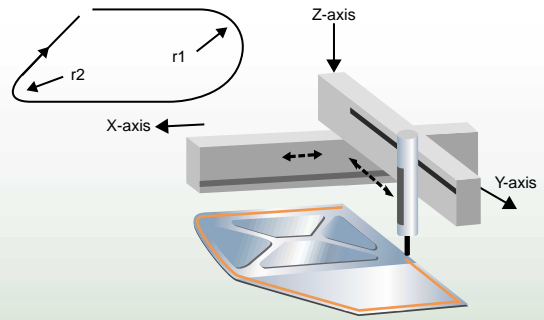

Drilling machine

- Speed-switching control

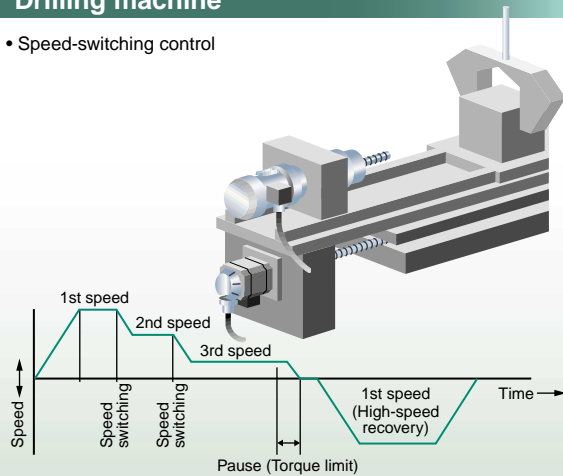

(Note) : There is not limit of number of speed-switching points.

Fixed-pitch hole drilling

- Speed/position switching control

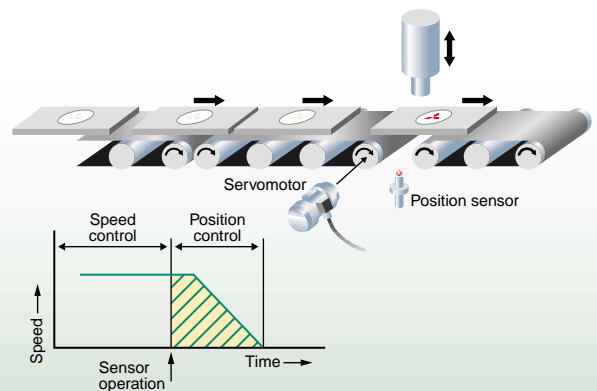

Roll feeder

- Fixed-pitch feed
- High speed, high frequency positioning
- High speed response

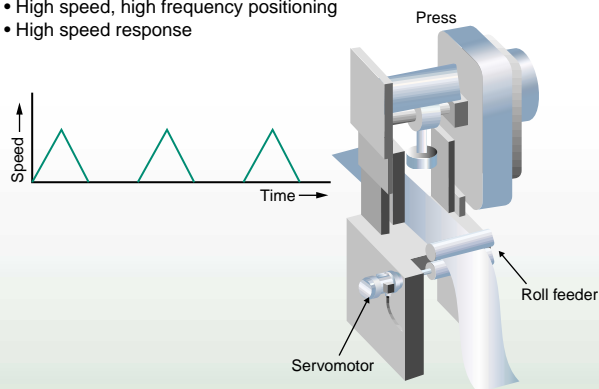

Spinner

- Rotary shaft specified position stop
- Speed control
- Speed, acceleration/deceleration time change during operation

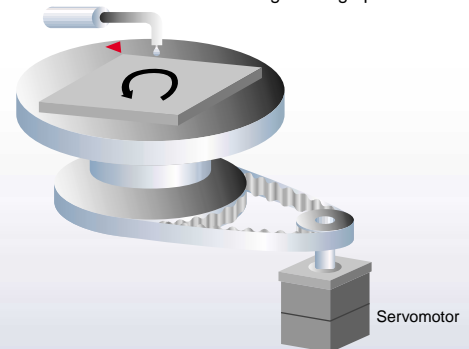

(Note) : Consult individually about the case applied to a spinner.
(It is necessary to use the operating system software with special specification according to the system.)

Functions

✓ Skip function

Positioning to the next positioning point by invalidating the positioning point during constant-speed control.

Uses : Handling positioning, etc.

✓ High speed reading function

Up to 11 data among 16 types (feed current value, deviation counter value, etc.) can be read simultaneously to the specified device using a signal from input module as a trigger.

Uses : Measured length, synchronized correction

✓ Negative speed change

Return to the reverse direction by using speed change during position control. The each axis retraces one's followed locus by setting the negative speed by the Motion dedicated instruction CHGV in the speed change.

Uses : Return operations

✓ Cancel function

The program processing during operation can be interrupted compulsorily.

✓ M-code FIN waiting function

Positioning start to the next point during constant-speed control can be executed at high speed than usual.

Uses : High response positioning start

✓ S-curve acceleration/deceleration

The acceleration/deceleration characteristics can be set with the optional ratio S-curve.

✓ Position follow-up control

By starting once, the setting value of positioning point is detected in real time, and the position control is executed by following the changing setting value.

✓ Speed change/pause/re-start

Positioning, speed change during JOG operation and pause/re-start can be executed simply using the Motion dedicated instruction CHGV.

✓ M-code output

M-codes between 0 and 255 can be outputted at each positioning point during positioning operation.

✓ 2 types of speed control

Two types of speed control are available using the position loops or speed loops.

✓ Dwell time free setting

Dwell time can be set for any value between 0 and 5000ms.

✓ Limit switch output

Up to 32 points ON/OFF output signal for the real current value, motor current and word device data, etc. during operation can be outputted at high-speed regardless of the Motion SFC program.

✓ Parameter block setting

Common setting items in positioning control can be set as parameter blocks up to 64 types, and freely selected.

✓ Teaching setting

The positioning points can be set with teaching in the test mode of MT Developer.

✓ Torque limit value change

Torque limit value change can be simply executed during positioning and JOG operation using the Motion dedicated instruction CHGT.

SV22 (Automatic Machinery Use)

Easy On-Screen Programming Using the Mechanical Support Language.

- Incorporating a mechanical support language that allows easy programming of the mechanical system. By combining a variety of software mechanical modules and Cam patterns, complex synchronized control and coordinated control can be achieved easily and at low costs. Ideal for controlling automatic machinery such as food processing and packaging.

■ Control flow

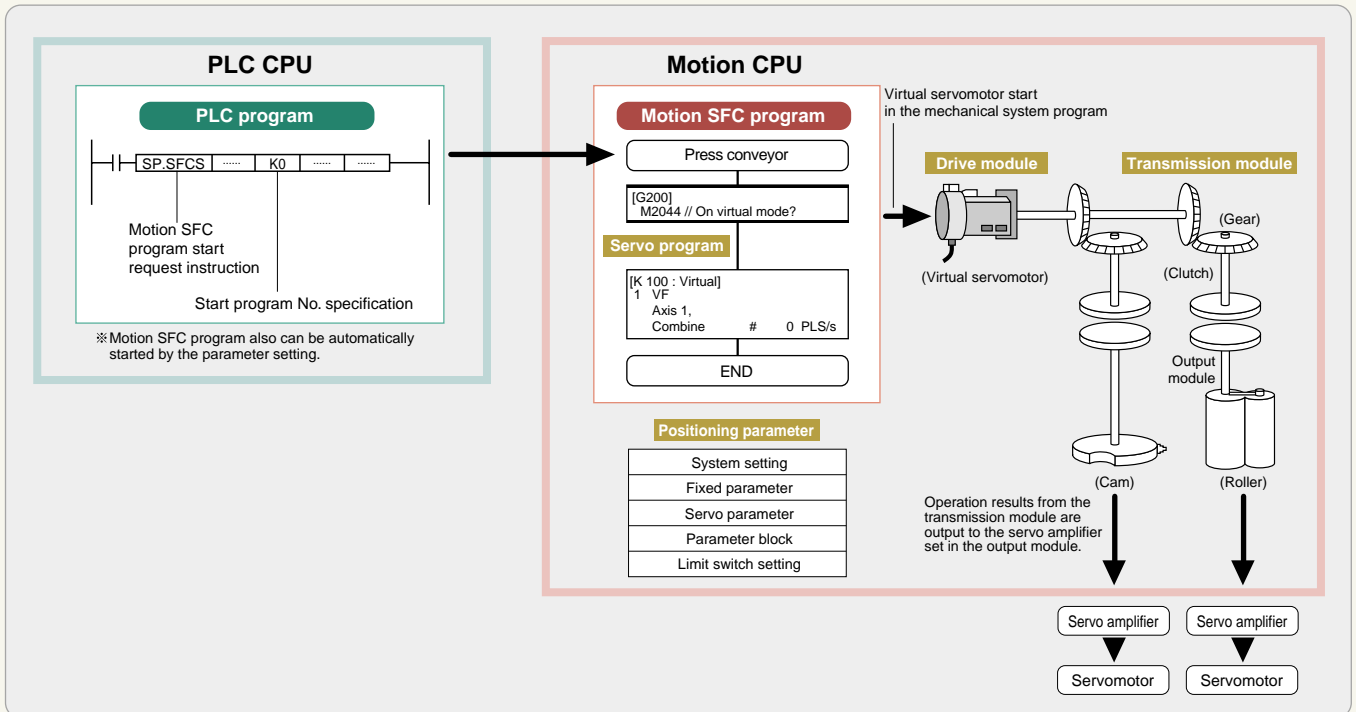

■ Mechanical modules

Class	Mechanical Module		Function Description
	Name	Appearance	
Drive module	Virtual servomotor		• It is used to drive the virtual axis of mechanical system program by the servo program or JOG operation.
	Synchronous encoder		• It is used to drive the virtual axis by the input pulses from the external synchronous encoder.
Virtual axis	Virtual main shaft	—	• This is a virtual "link shaft". • Drive module rotation is transferred to the transmission module.
	Virtual auxiliary input axis	—	• This is the auxiliary input axis for input to the differential gear of transmission module. • It is automatically displayed when a differential gear and gear are connected.
Transmission module	Gear		• The drive module rotation is transmitted to the output axis. • A setting gear ratio is applied to the travel value (pulse) input from the drive module, and then transmits to the output axis that it becomes in the setting rotation direction.
	Direct clutch		• Transmit or separate the drive module rotation to the output module. • There are a direct clutch transmitted directly and the smoothing clutch which performs the acceleration/deceleration and transmission by the smoothing time constant setting at the switching ON/OFF of the clutch.
	Smoothing clutch		• It can be selected the ON/OFF mode, address mode or the external input mode depending on the application. • Time constant specified method or amount of slip specified method can be selected as a smoothing method.

Class	Mechanical Module		Function Description
	Name	Appearance	
Transmission module	Speed change gear		• It is used to change speed of output module (roller). • The setting speed change ratio is applied to input axis speed, and transmits to the output axis.
	Differential gear		• Auxiliary input axis rotation is subtracted from virtual main shaft rotation and the result is transmitted to the output axis.
		• Auxiliary input axis rotation is subtracted from virtual main shaft rotation, and the result is transmitted to the output axis.	
Output module	Roller		• It is used to perform the speed control at the final output.
	Ball screw		• It is used to perform the linear positioning control at the final output.
	Rotary table		• It is used to perform the angle control at the final output.
	Cam		• It is used to control except the above. Position control is executed based on the Cam pattern setting data. • There are 2 Cam control modes: the two-way Cam and feed Cam.

■ Mechanical support language

Realizing mechanical operation using software

By replacing the mechanical system of main shafts, gears, clutches, and Cams with the software mechanical modules, the following merits can be realized.

- Machine is more compact and costs are lower.
- There are no worries over friction and service life for the main shaft, gear and clutch.
- Changing initial setup is simple.
- There is no error caused by mechanical precision, and system performance improves.

Advanced control using software Cam

Ideal Cam pattern control was achieved without problems, such as an error produced in the conventional Cam control, by processing the Cam control by software. The Cam control for the nozzle lowering control in contact with liquid surfaces, amount of filler control or smooth conveyance control, etc. can be realized simply. Exchanging of Cam for product type change is also possible easily by changing the Cam pattern only.

Easy programming on screen using a mouse



Programming monitor by mechanical support language

■ Software package for creating Cam curves SW3RN-CAMP

This package sets the Cam pattern when using software Cam control by mechanical support language. Flexible and highly precise Cam patterns can be created to match the required control. Complex Cam patterns are easy to program.

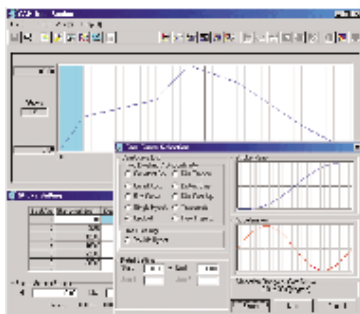

Creating Cam pattern

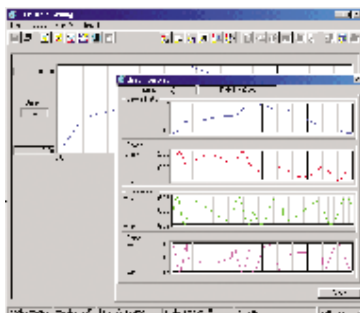

Graphic display of control state

11 types of Cam patterns

Whatever Cam curve you need can be created, by selecting and combining Cam patterns suited to your application among 11 types.

<Cam patterns>

- Constant-speed
- Cycloid
- Distorted constant-speed
- Single hypotenuse
- Constant-acceleration
- Distorted trapezoid
- Trapeclloid
- Double hypotenuse
- 5th curve
- Distorted sine
- Reverse trapeclloid

Can be set by free-form curves

Cam curves can be set by free curves using spline interpolation.

Selectable cam precision to match application

The resolution per cycle of Cam can be set in the following four stages.

• 256 • 512 • 1024 • 2048

Graphic display of control status

Control status information such as stroke ratio, speed and acceleration can be displayed in simple graphics.

SV22 (Automatic Machinery Use)

Application examples

Filling machine

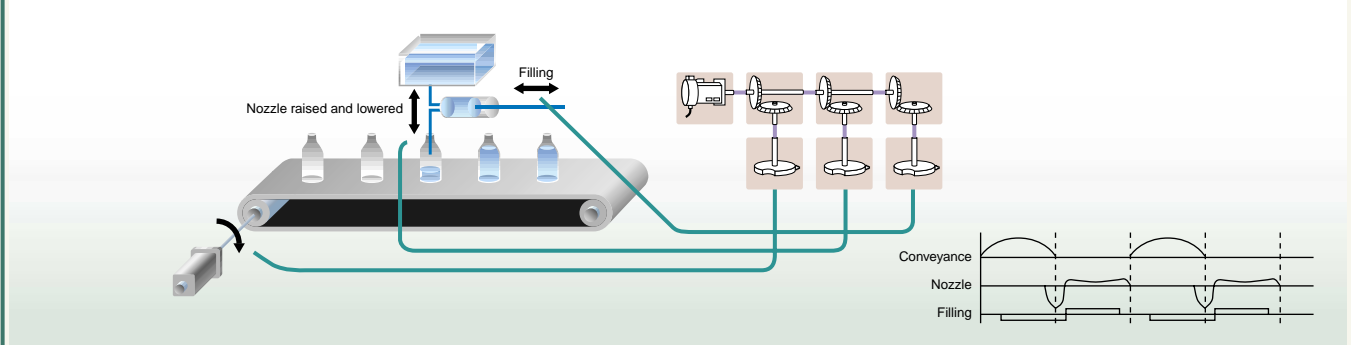

Draw control

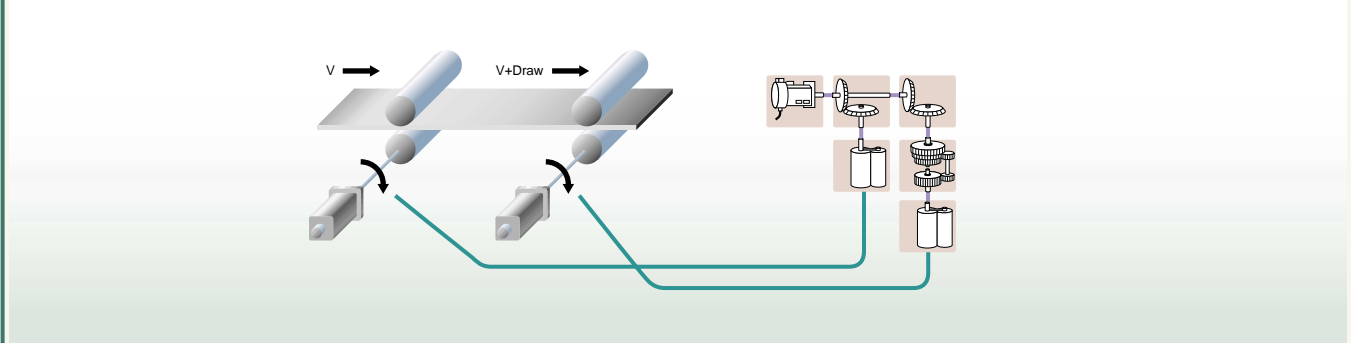

Press conveyance

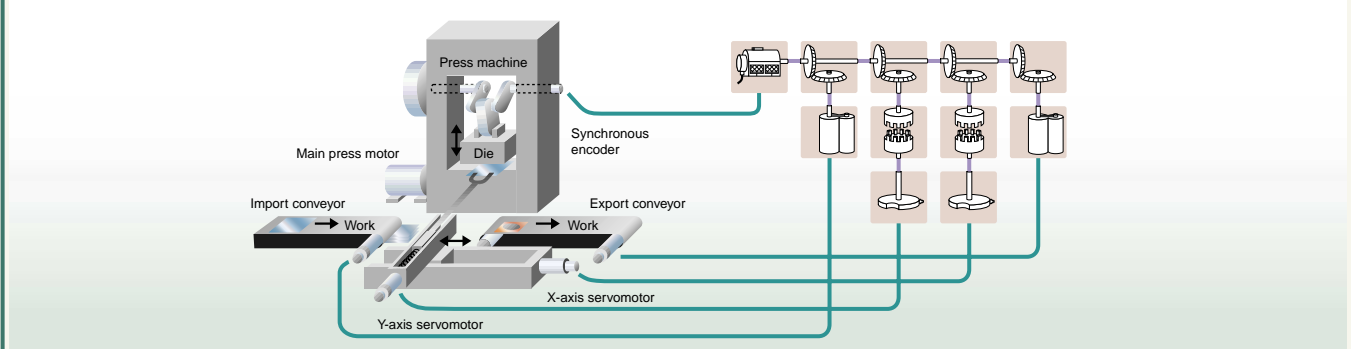

Three dimensional transfer

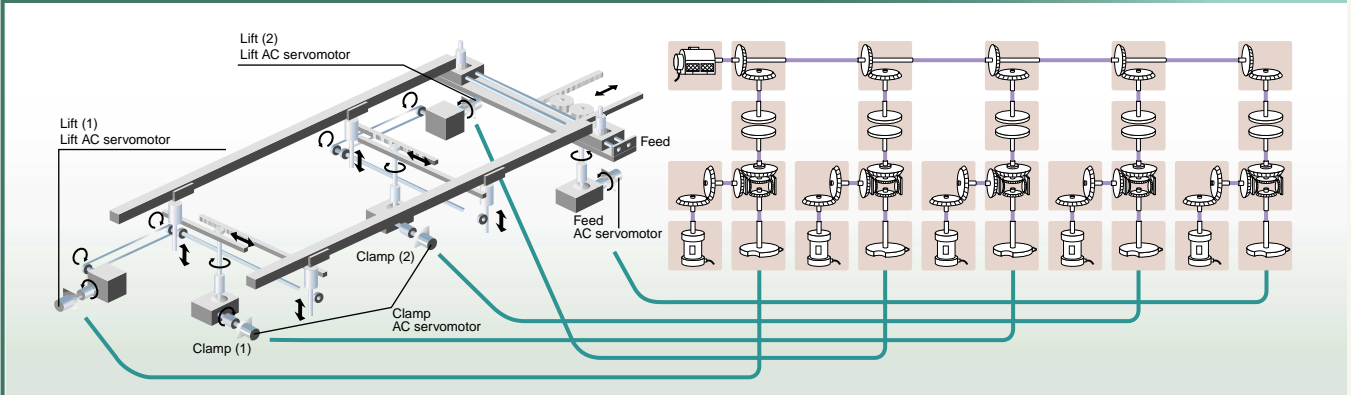

Printing machine

- Mark detection function
- Synchronous operation between axes
- Tandem operation
- Torque control

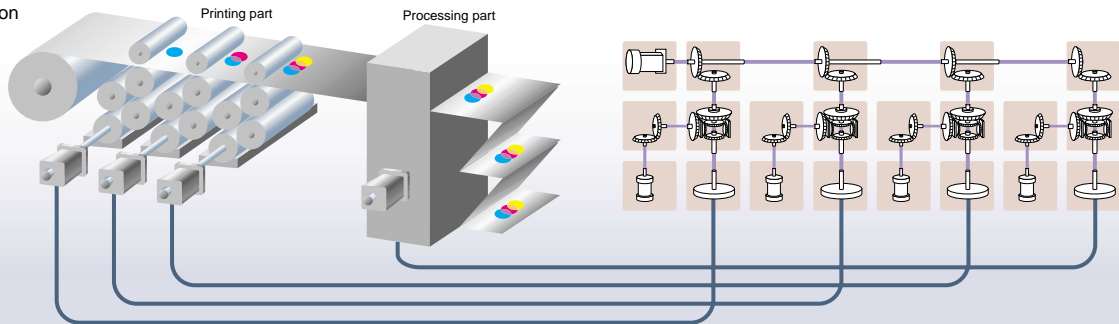

(Note) : Consult individually about the case applied to a printing machine.
 (It is necessary to use the operating system software, servo amplifiers and servomotors with special specification according to the system.)

Synchronous control

The servomotor can be operated by making it synchronous with other motor control conditions. Synchronous operation with simple setting for synchronous control and little tracking delay can be realized by a mechanical support language.

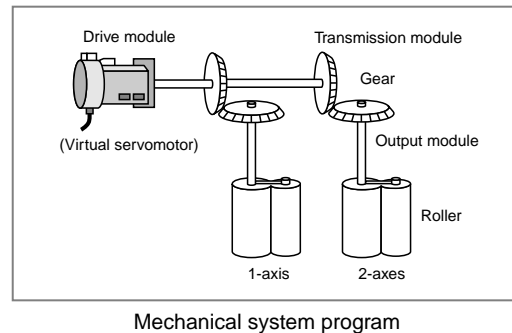
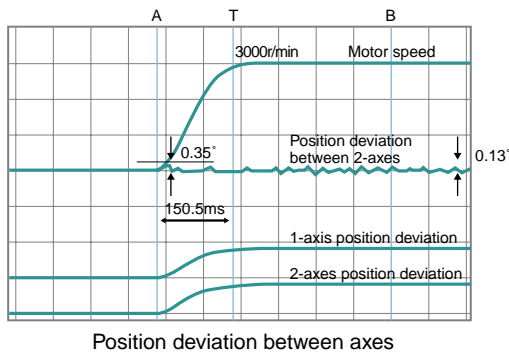

Cam pattern switching control

The multiple Cam patterns can be operated by switching for every work product type. Changing initial work time can be shortened sharply at the work product type change. Cam pattern can be also switched per one cycle, and it is applicable also to individual production of multiple product types.

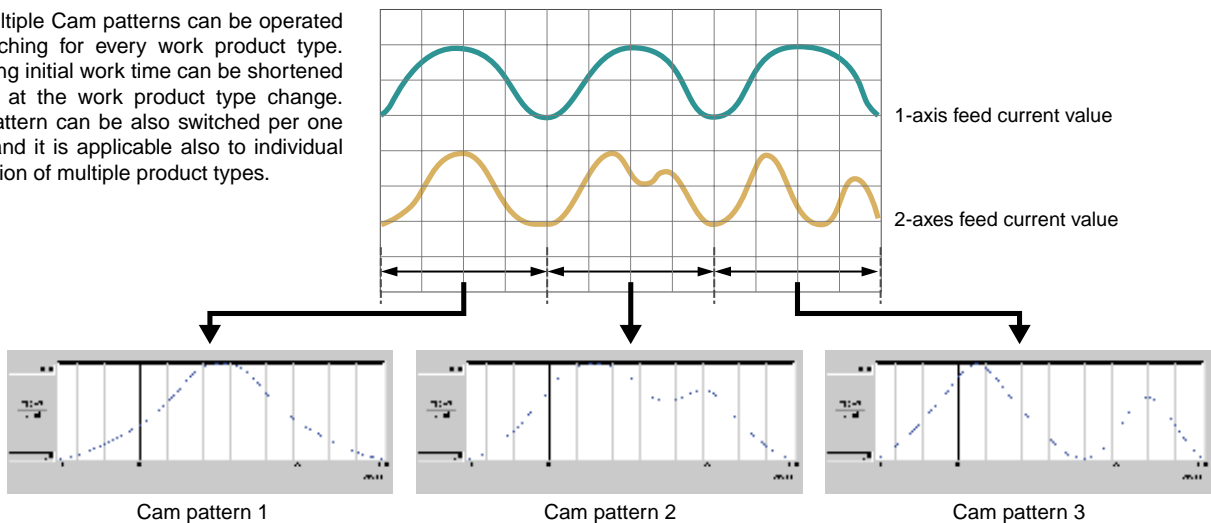

Overview of CPU Performance

■ Motion control

Item		Q173CPUN	Q172CPUN
Number of control axes		32 axes	8 axes
Operation cycle ^(Note-1) (default)	SV13	0.88ms : 1 to 8 axes 1.77ms : 9 to 16 axes 3.55ms : 17 to 32 axes	0.88ms : 1 to 8 axes
	SV22	0.88ms : 1 to 4 axes 1.77ms : 5 to 12 axes 3.55ms : 13 to 24 axes 7.11ms : 25 to 32 axes	0.88ms : 1 to 4 axes 1.77ms : 5 to 8 axes
Interpolation functions		Linear interpolation (Up to 4 axes), Circular interpolation (2 axes), Helical interpolation (3 axes)	
Control modes		PTP (Point to Point), Speed control, Speed/position switching control, Fixed-pitch feed, Constant-speed control, Position follow-up control, Speed switching control, High-speed oscillation control, Synchronous control (SV22)	
Acceleration/deceleration control		Automatic trapezoidal acceleration/deceleration, S-curve acceleration/deceleration	
Compensation function		Backlash compensation, Electronic gear	
Programming language		Motion SFC, Dedicated instruction, Mechanical support language (SV22)	
Servo program (dedicated instruction) capacity		14k steps	
Number of positioning points		3200 points (Positioning data can be set indirectly)	
Programming tool		IBM PC/AT	
Peripheral I/F		USB/RS-232/SSCNET	
Home position return function		Proximity dog type, Count type, Data set type (2 types)	
JOG operation function		Provided	
Manual pulse generator operation function		Possible to connect 3 modules	
Synchronous encoder operation function		Possible to connect 12 modules (SV22 use)	Possible to connect 8 modules (SV22 use)
M-code function		M-code output function provided, M-code completion wait function provided	
Limit switch output function		Number of output points : 32 points Watch data : Motion control data/Word device	
Absolute position system		Made compatible by setting battery to servo amplifier (Possible to select the absolute/incremental data method for each axis)	
Number of Motion related modules		Q172LX : 4 modules Q172EX : 6 modules Q173PX : 4 modules ^(Note-2)	Q172LX : 1 module Q172EX : 4 modules Q173PX : 3 modules ^(Note-2)

(Note-1) : The operation cycle is 1.77ms or more when using the MR-H□BN.

(Note-2) : The incremental synchronous encoder use (SV22). When connecting the manual pulse generator, you can use only one module.

■ Mechanical system program (SV22)

Item			Q173CPUN		Q172CPUN	
Control unit	Drive module	Virtual servomotor	PLS			
		Synchronous encoder				
	Output module	Roller	mm, inch			
		Ball screw				
		Rotary table				
Cam	Fixed as "degree"					
			mm, inch, PLS			
Mechanical system program	Drive module	Virtual servomotor	32	Total 44	8	Total 16
		Synchronous encoder	12		8	
	Virtual axis	Virtual main shaft	32	Total 64	8	Total 16
		Virtual auxiliary input axis	32		8	
	Transmission module	Gear (Note-1)	64		16	
		Clutch (Note-1)	64		16	
		Speed change gear (Note-1)	64		16	
		Differential gear (Note-1)	32		8	
	Differential gear (for the virtual main shaft) (Note-2)	32		8		
	Output module	Roller	32	Total 32	8	Total 8
		Ball screw	32		8	
		Rotary table	32		8	
		Cam	32		8	
Cam	Types		Up to 256			
	Resolution per cycle		256, 512, 1024, 2048			
	Memory capacity		132k bytes			
	Stroke resolution		32767			
	Control mode		Two-way Cam, feed Cam			

(Note-1) : The gear, clutch, speed change gear or differential gear module can be used only one module per one output module.
 (Note-2) : The differential gears connected to the virtual main shaft can be used only one module per one main shaft.

■ Motion SFC performance

Item			Q173CPUN/Q172CPUN		
Program capacity	Code total (Motion SFC chart + Operation control + Transition)		287k bytes		
	Text total (Operation control + Transition)		224k bytes		
Motion SFC program	Number of Motion SFC programs		256 (No.0 to 255)		
	Motion SFC chart size per program		Up to 64k bytes (Included Motion SFC chart comments)		
	Number of Motion SFC steps per program		Up to 4094 steps		
	Number of selective branches per branch		255		
	Number of parallel branches per branch		255		
	Parallel branch nesting		Up to 4 levels		
Operation control program (F/FS) / Transition program (G)	Number of operation control programs		4096 with F(Once execution type) and FS(Scan execution type) combined (F/FS0 to F/FS4095)		
	Number of transition programs		4096 (G0 to G4095)		
	Code size per program		Up to approx. 64k bytes (32766 steps)		
	Number of blocks(line) per program		Up to 8192 blocks (4 steps (minimum) per block)		
	Number of characters per block		Up to 128 (Included comments)		
	Number of operand per block		Up to 64 (Operand: Constants, Word devices, Bit devices)		
	() nesting per block		Up to 32		
Descriptive expression	Operation control program		Calculation expression/Bit conditional expression		
	Transition program		Calculation expression/Bit conditional expression/Comparison conditional expression		
Execute specification	Number of multi executed programs		Up to 256		
	Number of multi active programs		Up to 256 steps per all programs		
	Executed task	Normal task		Executed in motion main cycle	
		Event task (Execution can be masked.)	Fixed cycle	Executed in fixed cycle (0.88ms, 1.77ms, 3.55ms, 7.11ms, 14.2ms)	
			External interrupt	Executed when input ON is set among interrupt module (16 points)	
PLC interrupt			Executed with interrupt from PLC CPU		
NMI task		Executed when input ON is set among interrupt module (16 points)			
Number of I/O (X/Y) points			8192 points		
Number of real I/O (PX/PY) points			256 points		
Number of devices	Internal relays (M)	Total (M + L) 8192 points			
	Latch relays (L)				
	Link relays (B)	8192 points			
	Annunciators (F)	2048 points			
	Special relays (M)	256 points			
	Data registers (D)	8192 points			
	Link registers (W)	8192 points			
	Special registers (D)	256 points			
	Motion registers (#)	8192 points			
Coasting timers (FT)	1 point (888μs)				

Overview of CPU Performance

Software packages

Software	Application	Model name		Note
		Q173CPUN	Q172CPUN	
Operating system software	Conveyor assembly use SV13	SW6RN-SV13QB	SW6RN-SV13QD	—
	Automatic machinery use SV22	SW6RN-SV22QA	SW6RN-SV22QC	
Programming software	Conveyor assembly use SV13	SW6RN-GSV13P		Included in the "Integrated start-up support software".
	Automatic machinery use SV22	SW6RN-GSV22P		
		SW3RN-CAMP		
	Digital oscilloscope use	SW6RN-DOSCP		

Integrated start-up support software packages MT Developer

Model name	Details
SW6RN-GSVPROE	<ul style="list-style-type: none"> Conveyor assembly software : SW6RN-GSV13P Automatic machinery software : SW6RN-GSV22P Cam data creation software : SW3RN-CAMP Digital oscilloscope software : SW6RN-DOSCP Communication system software : SW6RN-SNETP Document print software : SW3RN-DOCPNRP
	SW6RNC-GSVHELPE (Operation manual [1 CD-ROM])
	Installation manual
SW6RNC-GSVSETE	SW6RNC-GSVPROE
	A30CD-PCF (SSC I/F card (PCMCIA TYPE II 1CH/card))
	Q170CDCBL3M (A30CD-PCF cable 3m(9.84ft.))



System component

<Motion dedicated equipments>

Part name	Model name	Description	Standards
Motion CPU module	Q173CPUN	Up to 32 axes control, Operation cycle 0.88ms~	CE, UL
	Q172CPUN	Up to 8 axes control, Operation cycle 0.88ms~	CE, UL
Servo external signals interface module	Q172LX	Servo external signal input 32 points (FLS, RLS, STOP, DOG/CHANGEX8)	CE, UL
Serial absolute synchronous encoder interface module	Q172EX	Serial absolute synchronous encoder MR-HENC interfaceX2, Tracking input 2 points	CE, UL
Manual pulse generator interface module	Q173PX	Manual pulse generator MR-HDP01/synchronous encoder interfaceX3, Tracking input 3 points	CE, UL
Serial absolute synchronous encoder	MR-HENC	Resolution: 16384PLS/rev, Permitted speed: 4300r/min	CE, UL
Serial absolute synchronous encoder cable	MR-JHSCBL□M-H, L	Serial absolute synchronous encoder ↔ Q172EX (When not using the tracking enable signal.)	—
Dividing unit	Q173DV	For dividing SSCNET lines of Q173CPUN (Attachment: Battery holder for IC-RAM memory backup)	—
Battery unit	Q170BAT	For IC-RAM memory backup of Motion CPU module	—
Battery	MR-BAT/A6BAT	For backup of serial absolute synchronous encoder, for backup of external battery of Motion CPU module	—
Manual pulse generator	MR-HDP01	Resolution: 25PLS/rev, Permitted speed: 200r/min, Open collector output	—
SSCNET cable	Q173HB△CBL□M (Note-1)	• Q173CPUN ↔ MR-H□BN	Refer to the "SSCNET cable model" of next page for cable length and details.
	Q173J2B△CBL□M (Note-1)	• Q173CPUN ↔ MR-J2□-B (Note-2)	
	Q173DVCBL□M	• Q173CPUN ↔ Q173DV	
	Q172HBCBL□M	• Q172CPUN ↔ MR-H□BN	
		• MR-H□BN ↔ FR-V5NS (Note-3)	
	Q172HBCBL□M-B	• Q172CPUN ↔ MR-H□BN and Q170BAT	
	Q172J2BCBL□M	• Q172CPUN ↔ MR-J2□-B (Note-2)	
		• MR-J2□-B (Note-2) ↔ FR-V5NS (Note-3)	
		• Q173DV ↔ FR-V5NS (Note-3)	
	Q172J2BCBL□M-B	• Q172CPUN ↔ MR-J2□-B (Note-2) and Q170BAT	
FR-V5NSCBL□	• Q172CPUN ↔ FR-V5NS (Note-3)		
	• FR-V5NS (Note-3) ↔ FR-V5NS (Note-3)		
MR-HBUS□M	• MR-H□BN ↔ MR-H□BN		
MR-J2HBUS□M-A	• MR-H□BN ↔ MR-J2□-B (Note-2)		
	• MR-H□BN ↔ Q173DV		
MR-J2HBUS□M	• MR-J2□-B (Note-2) ↔ MR-J2□-B (Note-2)		
	• MR-J2□-B (Note-2) ↔ Q173DV		
SSC I/F board	A30BD-PCF	ISA bus loading type, 2CH/board	—
SSC I/F card	A30CD-PCF	PCMCIA TYPE II, 1CH/card	—
SSC I/F board cable	Q170BDCBL□M	For A30BD-PCF 3m (9.84ft.), 5m (16.4ft.), 10m (32.8ft.)	—
SSC I/F card cable	Q170CDCBL□M	For A30CD-PCF 3m (9.84ft.), 5m (16.4ft.), 10m (32.8ft.)	—

(Note-1) △=Number of lines (none: 1 Line, 2: 2 Lines, 4: 4 Lines)

(Note-2) MR-J2□-B : MR-J2S□B/MR-J2M-P8B/MR-J2□B/MR-J2-03B5

(Note-3) SSCNET communication option for vector inverter FREQROL-V500 series (Coming soon!)

<PLC common equipments>

Part name	Model name	Description	Standards
PLC CPU module	Q00CPU	Program capacity 8k	CE, UL
	Q01CPU	Program capacity 14k	CE, UL
	Q02CPU	Program capacity 28k	CE, UL
	Q02HCPU	Program capacity 28k	CE, UL
	Q06HCPU	Program capacity 60k	CE, UL
	Q12HCPU	Program capacity 124k	CE, UL
	Q25HCPU	Program capacity 252k	CE, UL
CPU base unit	Q33B	Power supply + CPU + 3 slots I/O modules, For Q series module	CE, UL
	Q35B	Power supply + CPU + 5 slots I/O modules, For Q series module	CE, UL
	Q38B	Power supply + CPU + 8 slots I/O modules, For Q series module	CE, UL
	Q312B	Power supply + CPU + 12 slots I/O modules, For Q series module	CE, UL
Extension base unit	Q63B	Power supply + 3 slots I/O modules, For Q series module	CE, UL
	Q65B	Power supply + 5 slots I/O modules, For Q series module	CE, UL
	Q68B	Power supply + 8 slots I/O modules, For Q series module	CE, UL
Extension cable	Q612B	Power supply + 12 slots I/O modules, For Q series module	CE, UL
	QC□B	Length 0.45m(1.48ft.), 0.6m(1.97ft.), 1.2m(3.9ft.), 3m(9.8ft.), 5m(16.4ft.), 10m(32.8ft.)	—
Power supply module	Q61P-A1	100 to 120VAC input/5VDC 6A output	CE, UL
	Q61P-A2	200 to 240VAC input/5VDC 6A output	CE, UL
	Q63P	24VDC Input/5VDC 6A output	CE, UL
	Q64P	100 to 120VAC/200 to 240VAC input/5VDC 8.5A output	CE, UL

SSCNET connecting methods

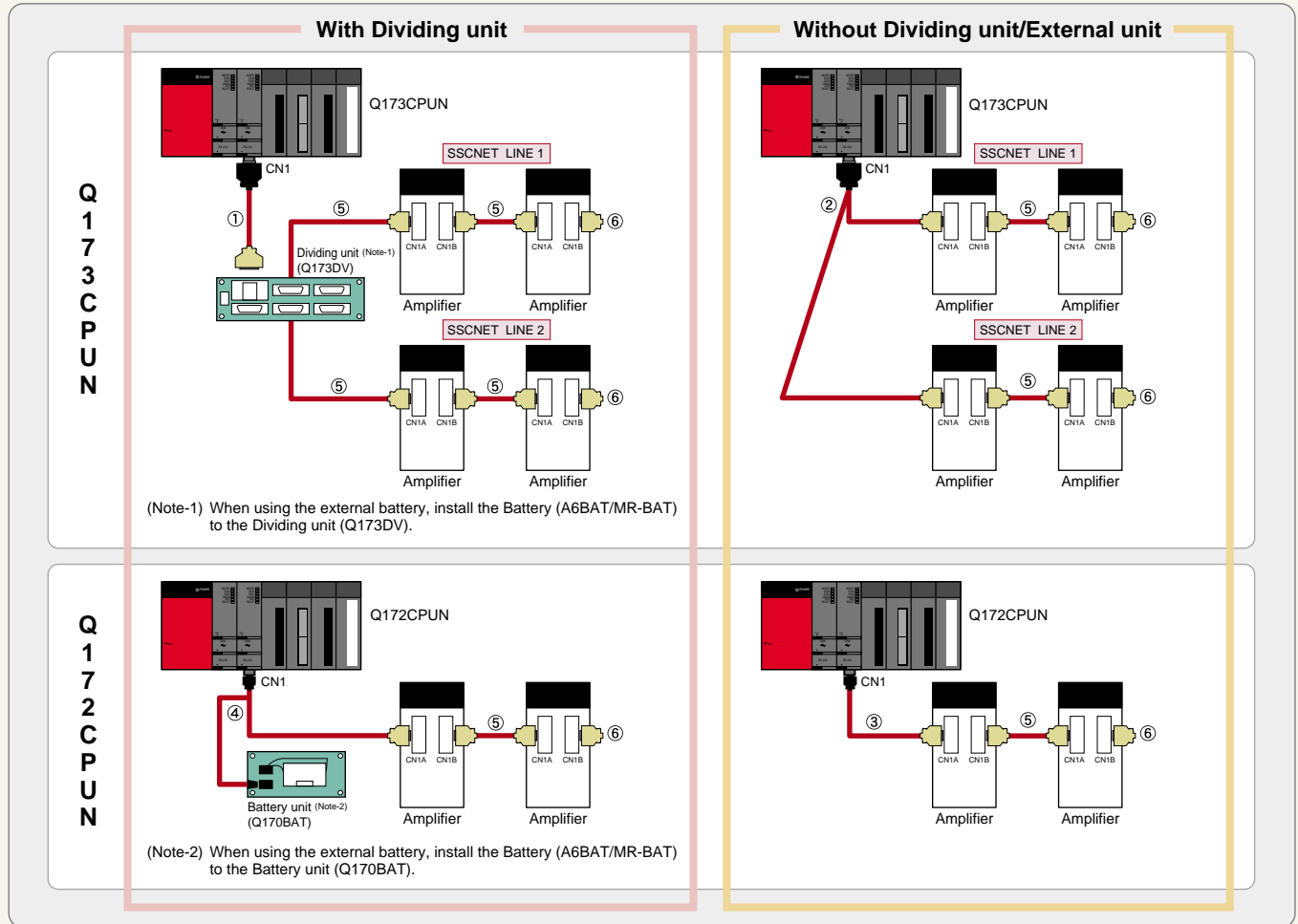

SSCNET cable models

No.	Application	Model name (Note-2)	Cable length	Descriptions
①	Q173CPUN ↔ Dividing unit	Q173DVCBL□M	0.5m(1.64ft.), 1m(3.28ft.)	• Q173CPUN ↔ Dividing unit Q173DV
②	Q173CPUN ↔ Amplifier (Note-1)	Q173J2B△CBL□M (Note-3)	0.5m(1.64ft.), 1m(3.28ft.), 5m(16.4ft.)	• Q173CPUN ↔ Servo amplifier MR-J2□-B (Note-4)
		Q173HB△CBL□M (Note-3)		• Q173CPUN ↔ Servo amplifier MR-H□BN
③	Q172CPUN ↔ Amplifier	Q172J2BCBL□M	0.5m(1.64ft.), 1m(3.28ft.), 5m(16.4ft.)	• Q172CPUN ↔ Servo amplifier MR-J2□-B (Note-4)
		Q172HBCBL□M		• Q172CPUN ↔ Servo amplifier MR-H□BN
		FR-V5NSCBL□	0.5m(1.64ft.), 1m(3.28ft.), 5m(16.4ft.), 10m(32.8ft.), 20m(65.6ft.)	• Q172CPUN ↔ FR-V5NS (Note-5)
④	Q172CPUN ↔ Amplifier ↔ Battery unit	Q172J2BCBL□M-B	0.5m(1.64ft.), 1m(3.28ft.), 5m(16.4ft.)	• Q172CPUN ↔ Servo amplifier MR-J2□-B (Note-4) ↔ Battery unit Q170BAT
		Q172HBCBL□M-B		• Q172CPUN ↔ Servo amplifier MR-H□BN ↔ Battery unit Q170BAT
⑤	Amplifier ↔ Amplifier Dividing unit ↔ Amplifier	MR-J2HBUS□M	0.5m(1.64ft.), 1m(3.28ft.), 5m(16.4ft.)	• Servo amplifier MR-J2□-B (Note-4) ↔ Servo amplifier MR-J2□-B (Note-4)
		MR-J2HBUS□M-A		• Dividing unit Q173DV ↔ Servo amplifier MR-J2□-B (Note-4)
		MR-HBUS□M		• Servo amplifier MR-H□BN ↔ Servo amplifier MR-J2□-B (Note-4)
		Q172J2BCBL□M		• Dividing unit Q173DV ↔ Servo amplifier MR-H□BN
		Q172HBCBL□M		• Servo amplifier MR-H□BN ↔ Servo amplifier MR-H□BN
⑥	Terminal connector	FR-V5NSCBL□	0.5m(1.64ft.), 1m(3.28ft.), 5m(16.4ft.), 10m(32.8ft.), 20m(65.6ft.)	• Servo amplifier MR-J2□-B (Note-4) ↔ FR-V5NS (Note-5)
		FR-V5NS	0.5m(1.64ft.), 1m(3.28ft.), 5m(16.4ft.), 10m(32.8ft.), 20m(65.6ft.)	• Dividing unit Q173DV ↔ FR-V5NS (Note-5)
⑥	Terminal connector	MR-TM	-	• FR-V5NS (Note-5) ↔ FR-V5NS (Note-5)
		MR-A-TM	-	• Connect to the last servo amplifier MR-H□BN via SSCNET
				• Connect to the last servo amplifier MR-J2□-B (Note-4) via SSCNET

(Note-1) : Branch from a connector on the Q173CPUN side according to the number of lines.

(Note-2) : □=cable length 5m(16.4ft.) of cable length is indicated as "05" inside □.

(Note-3) : △=SSCNET LINE No. (none(LINE1), 2(LINE1/2), 4(LINE1,2,3,4))

(Note-4) : MR-J2□-B : MR-J2S□-B/MR-J2M-P8B/MR-J2□-B/MR-J2-03B5

(Note-5) : SSCNET communication option for vector inverter FREQROL-V500 series(Coming soon!)

Combinations of Servo Amplifier and Servomotor



(As of Apr. 2003)

Servo amplifier / Servomotor		MR-J2M series				MR-J2-Super series										Motor capacity (kW)		
		MR-J2M-				MR-J2S-												
		10DU	20DU	40DU	70DU	10B	20B	40B	60B	70B	100B	200B	350B	500B	700B			
	Ultra low inertia, Small capacity HC-MFS 3000r/min series	HC-MFS053	●				●										0.05	
		HC-MFS13	●				●										0.1	
		HC-MFS23		●				●									0.2	
		HC-MFS43			●				●								0.4	
		HC-MFS73				●					●						0.75	
	Low inertia, Small capacity HC-KFS 3000r/min series	HC-KFS053	●				●										0.05	
		HC-KFS13	●				●										0.1	
		HC-KFS23		●				●									0.2	
		HC-KFS43			●				●								0.4	
		HC-KFS73				●					●						0.75	
	Low inertia, Small capacity HC-KFS Ultra high velocity motor series	HC-KFS46								▲							0.4	
		HC-KFS410								▲							0.4	
	Middle inertia, Middle capacity HC-SFS 1000r/min series	HC-SFS81									●						0.85	
		HC-SFS121										●					1.2	
		HC-SFS201										●					2.0	
		HC-SFS301											●				3.0	
		Middle inertia, Middle capacity HC-SFS 2000r/min series	HC-SFS52							●								0.5
			HC-SFS102									●						1.0
			HC-SFS152										●					1.5
			HC-SFS202										●					2.0
			HC-SFS352											●				3.5
		Middle inertia, Middle capacity HC-SFS 3000r/min series	HC-SFS502												●			5.0
		HC-SFS702													●		7.0	
		HC-SFS53							●								0.5	
		HC-SFS103									●						1.0	
		HC-SFS153										●					1.5	
	Ultra low inertia, Middle capacity HC-RFS 3000r/min series	HC-RFS203										●					2.0	
		HC-RFS353											●				3.5	
		HC-RFS503												●			5.0	
		HC-RFS103										●					1.0	
		HC-RFS153										●					1.5	
	Flat, Small capacity HC-UFS 3000r/min series	HC-UFS13	●					●									0.1	
		HC-UFS23		●					●								0.2	
		HC-UFS43			●					●							0.4	
		HC-UFS73				●											0.75	
		HC-UFS72											●				0.75	
		Flat, Middle capacity HC-UFS 2000r/min series	HC-UFS152										●					1.5
			HC-UFS202											●				2.0
		HC-UFS352												●			3.5	
		HC-UFS502													●		5.0	
	Low inertia, Middle capacity HC-LFS 2000r/min series	HC-LFS52							●								0.5	
		HC-LFS102									●						1.0	
		HC-LFS152										●					1.5	
		HC-LFS202											●				2.0	
		HC-LFS302												●			3.0	

▲ : Special amplifier required



(As of Apr. 2003)

Servo amplifier		MR-J2-Super series											Motor capacity (kW)
		MR-J2S-											
Servomotor		500B	700B	11KB	15KB	22KB	30KB	37KB	30KB4	37KB4	45KB4	55KB4	
		Low inertia, Middle/large capacity HA-LFS 1000r/min series	HA-LFS601		●								
HA-LFS801				●									8.0
HA-LFS12K1				●									12.0
HA-LFS15K1					●								15.0
HA-LFS20K1						●							20.0
HA-LFS25K1						●							25.0
HA-LFS30K1							●						30.0
HA-LFS37K1								●					37.0
HA-LFS30K14									●				30.0
HA-LFS37K14									●			37.0	
Low inertia, Middle/large capacity HA-LFS 1500r/min series	HA-LFS701M		●										7.0
	HA-LFS11K1M			●									11.0
	HA-LFS15K1M				●								15.0
	HA-LFS22K1M					●							22.0
	HA-LFS30K1M						●						30.0
	HA-LFS37K1M							●					37.0
	HA-LFS30K1M4								●				30.0
	HA-LFS37K1M4									●			37.0
	HA-LFS45K1M4										●		45.0
HA-LFS50K1M4											●	50.0	
Low inertia, Middle/large capacity HA-LFS 2000r/min series	HA-LFS502	●											5.0
	HA-LFS702		●										7.0
	HA-LFS11K2			●									11.0
	HA-LFS15K2				●								15.0
	HA-LFS22K2					●							22.0
	HA-LFS30K2						●						30.0
	HA-LFS37K2							●					37.0
	HA-LFS30K24								●				30.0
	HA-LFS37K24									●			37.0
HA-LFS45K24										●		45.0	
HA-LFS55K24											●	55.0	



(As of Apr. 2003)

Servo amplifier		MR-J2-	Motor capacity (kW)
		03B5	
Compact size, Small capacity HC-AQ series	HC-AQ0135D	●	0.01
	HC-AQ0235D	●	0.02
	HC-AQ0335D	●	0.03

※ An absolute system is not available for the MR-J2B-03B5.

Exterior Dimensions

CPU module Q173CPUN

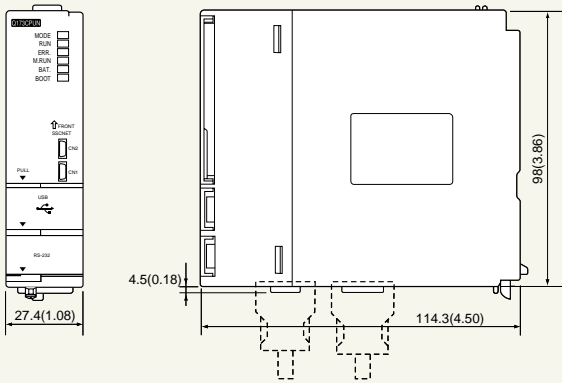

[Unit : mm (inch)]

CPU module Q172CPUN

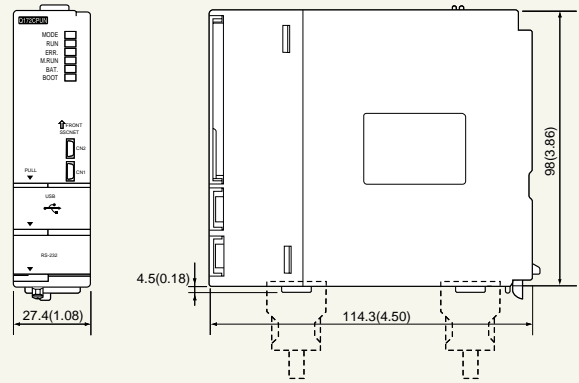

[Unit : mm (inch)]

Servo external signals interface module Q172LX

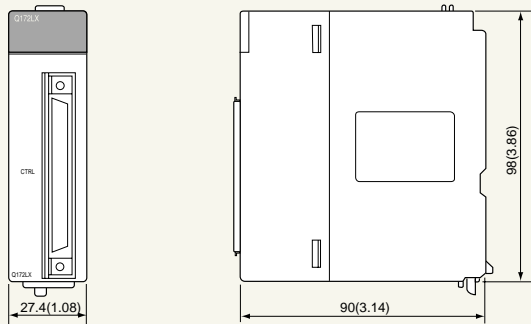

[Unit : mm (inch)]

Serial absolute synchronous encoder interface module Q172EX

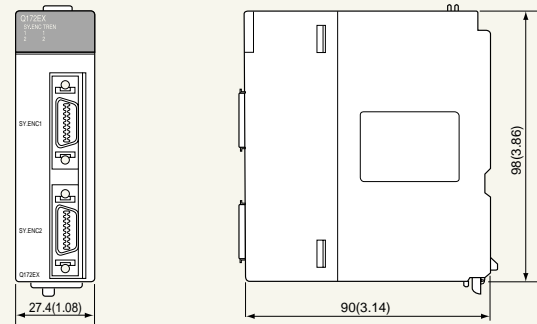

[Unit : mm (inch)]

Manual pulse generator interface module Q173PX

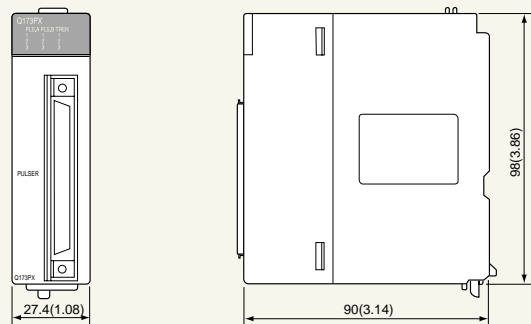

[Unit : mm (inch)]

Mounting

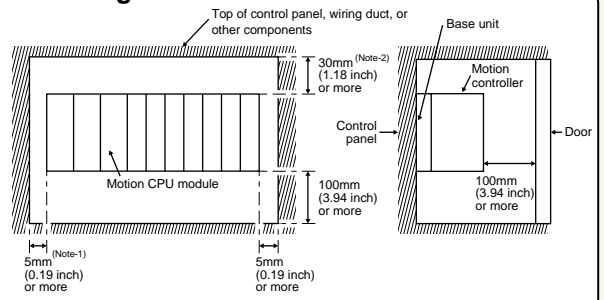

(Note-1) : 20mm(0.79 inch) or more when without removing the adjacent module.
 (Note-2) : 40mm(1.58 inch) or more when the height of a wiring duct is 50mm (1.97 inch) or more.

Base unit Q3 B/Q6 B

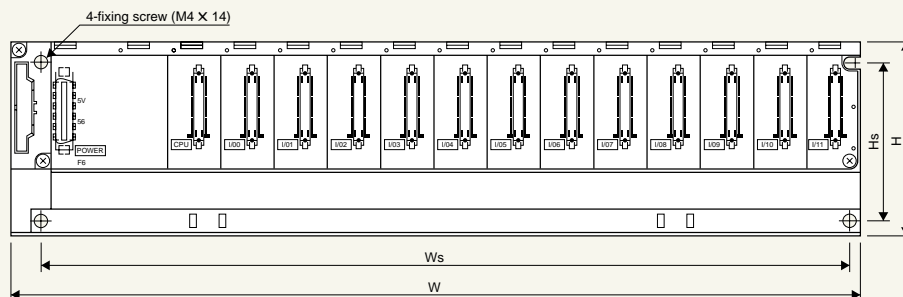

	CPU base			Extension base		
	Q35B	Q38B	Q312B	Q65B	Q68B	Q612B
W	245 (9.65)	328 (12.92)	439 (17.30)	245 (9.65)	328 (12.92)	439 (17.30)
Ws	224.5 (8.85)	308 (12.14)	419 (16.51)	222.5 (8.77)	306 (12.06)	417 (16.43)
H	98(3.86)					
Hs	80(3.16)					

[Unit : mm (inch)]

Serial absolute synchronous encoder MR-HENC

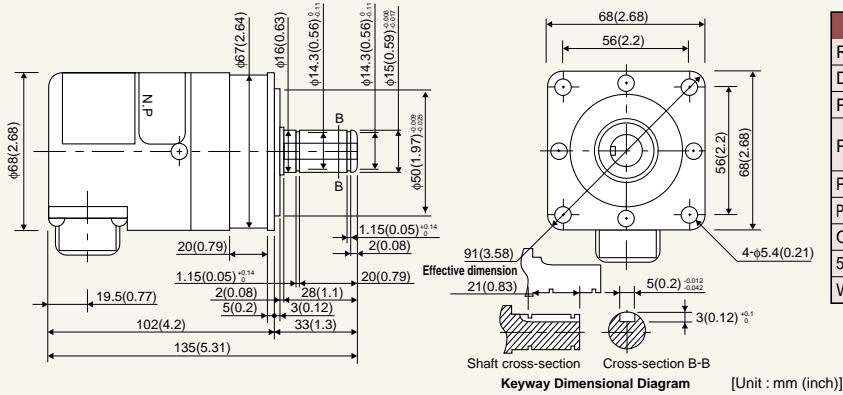

Item	Specifications
Resolution	16384PLS/rev
Direction on increase	Counter clockwise (viewed from end of axis)
Protective construction	IP52
Permitted axis load	Radial : Up to 98N Thrust : Up to 49N
Permissible rotation speed	4300r/min
Permissible angular acceleration	40000rad/s ²
Operating temperature	-5 to 55°C (23 to 131°F)
5VDC consumption current	0.15A
Weight	1.5kg

Manual pulse generator MR-HDP01

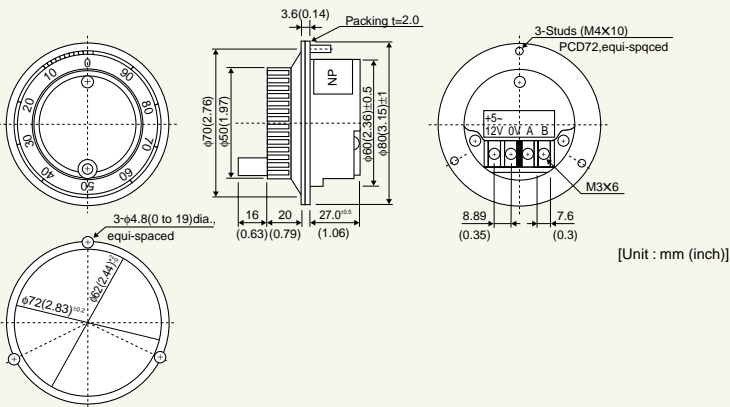

Item	Specifications
Pulse resolution	25PLS/rev (100PLS/rev at magnification of 4)
Output voltage	Input voltage > -1V (Note)
Life	More than 1,000,000 revolutions at 200r/min
Permitted axis load	Radial : Up to 19.6N Thrust : Up to 9.8N
Operating temperature	-10 to 60°C (14 to 140°F)
5VDC consumption current	0.06A
Weight	0.4kg

(Note) : When using an external power supply, necessary to 5V power supply.

Dividing unit Q173DV

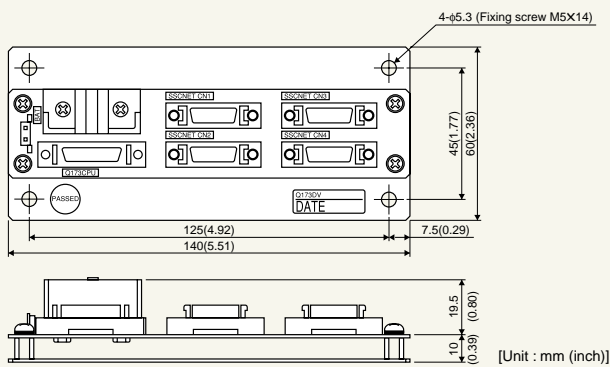

Battery unit Q170BAT

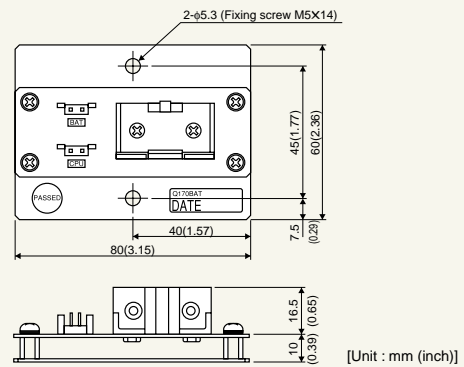

For safe use

- To use the products given in this catalog properly, always read the "manuals" before starting to use them.
- This product has been manufactured as a general-purpose part for general industries, and has not been designed or manufactured to be incorporated in a device or system used in purposes related to human life.
- Before using the product for special purposes such as nuclear power, electric power, aerospace, medicine or passenger movement vehicles, consult with Mitsubishi.
- This product has been manufactured under strict quality control. However, when installing the product where major accidents or losses could occur if the product fails, install appropriate backup or failsafe functions in the system.

Precautions for Choosing the Products

Mitsubishi will not be held liable for damage caused by factors found not to be the cause of Mitsubishi; machine damage or lost profits caused by faults in the Mitsubishi products; damage, secondary damage, accident compensation caused by special factors unpredictable by Mitsubishi; damages to products other than Mitsubishi products; and to other duties.