

## Preface

Thank you for purchasing the Pro-face GP3000 series RGB Input Unit, “GP3000-RGB201” (hereafter referred to as the “RGB unit”).

This unit is intended for use with the expansion unit interface of the Pro-face GP3000 series<sup>\*1</sup> programmable operator interface (hereafter referred to as the “Display unit”), and as a RGB input interface with any of the above mentioned Display units.

Before using the RGB unit, please be sure to read this manual and other related manuals to fully understand all the settings and functions.

<sup>\*1</sup> For the compatible models, please refer to the following.

**SEE→** *Applicable Products (page 5)*

### NOTICE

1. Copying this manual's contents, either in whole or in part, is prohibited without the express permission of Digital Electronics Corporation, Japan.
2. The information contained in this manual is subject to change without notice.
3. If you find any errors or omissions in this document, please contact Digital Electronics Corporation to report your findings.
4. Please be aware that Digital Electronics Corporation shall not be held liable by the user for any damages, losses, or third party claims arising from the uses of this product.

© 2009 Digital Electronics Corporation. All rights reserved.





Product names used in this manual are the trademarks / registered trademarks of their respective owners.

## Essential Safety Precautions

All safety-related procedures stated in this document must be followed to operate the RGB unit correctly and safely. Be sure to read this manual and any related documents thoroughly to understand the correct operation and functions of the RGB unit.



### Safety Icons

Throughout this manual, these icons provide essential safety information for RGB unit operation procedures requiring special attention. These icons indicate the following levels of danger:

 <b>WARNING</b>	Indicates situations where death, severe injury, or major equipment damage can occur.
 <b>CAUTION</b>	Indicates situations where slight injury or minor equipment damage can occur.
	Indicates actions or procedures that should <b>NOT</b> be performed.
	Indicates actions or procedures that <b>MUST</b> be performed to ensure correct unit operation.

---

### **WARNING**

-  Due to the possibility of an electrical shock, be sure to unplug the Display unit's power supply prior to installing the RGB unit.
-  Be sure to design your system so that a communication fault between Display unit and external device (PLC, etc.) will not cause equipment to malfunction. This is to prevent any possibility of injury or equipment damage.
-  Do not modify the RGB unit. Doing so may cause a fire or an electric shock.

---

### **CAUTION**

### General Safety Precautions

-  Do not allow water, liquids, or metal particles to enter into the RGB unit's case, otherwise it can cause a malfunction or electrical shock.

- ⊘ Avoid storing or operating the RGB unit in locations where it will be exposed to direct sunlight, high temperature, excessive dust, or vibration.
- ⊘ Avoid storing or operating the RGB unit in locations where large and sudden temperature changes can occur, possibly causing condensation.
- ⊘ Do not store or operate the RGB unit where chemicals can evaporate, be present in the air and adhere to the unit.
- ⊘ Since the RGB unit is a precision instrument, do not store or operate it in locations where strong physical contact or excessive vibration can occur.
- ⊘ Do not use paint thinner or organic solvents to clean the outside of the RGB unit. Instead, soak a soft cloth in a diluted neutral detergent, wring it tightly and then wipe the unit's outside case.

## Unit Disposal



- ❗ When the RGB unit is disposed of, it should be done so according to your country's regulations for similar types of industrial waste.

## Usage Precautions

- When using RGB signal input, a blue background may appear momentarily while the screen is adjusted or when a PC screen is switched. This phenomenon is normal and the RGB unit is not malfunctioning.
- With some types of RGB signals, the displayed images or RGB output images may contain noise or may blur during the screen adjustment. It is possible that these problems cannot be adjusted completely, given the RGB unit's available range of adjustment.
- When images without the supported resolution or refresh rate are input, a blue background screen will appear.
- Use a RGB cable with a connector of 18 mm (0.71 in.) or less in thickness.
- Use a USB cable with a connector of 8.5 mm (0.33 in.) or less in thickness.
- Turn the PC power off before removing the USB cable. Removal of the USB cable while the electricity is on may result in unstable PC operation. When the USB cable is disconnected, reboot the PC.

## Information Symbols

This manual uses the following icons:

	Indicates that failure to follow the instructions given with this icon may cause the RGB unit to malfunction or data to disappear.
	Contains additional or useful information on operations.
(1) (2)	Indicates procedure steps. Be sure to follow these procedures in the order they are written.
*	Indicates the description of footnote in the text.
	Indicates pages containing related information or related manuals.
GP-Pro EX	Indicates the Screen editor software for the Pro-face GP3000 series.

## Package Contents

RGB unit (1)

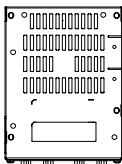

Hardware Manual <This Manual> (1)

Warning/Caution Information (1)

Driver CD (1)

Fixing Screws (4)

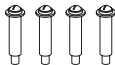

USB Cable Holder (mini-B) 1 set

(USB Holder (2))

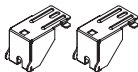

(USB Holder Fixing Screws (2))



This unit has been carefully packed, with special attention to quality. However, should you find anything damaged or missing, please contact your local distributor immediately.

## Applicable Products

### ■Applicable Units

GP3000 Series	AGP-35*0T, AGP-36*0T, AGP-37*0T
---------------	---------------------------------

### ■Applicable Software

GP3000 Series	GP-Pro EX Ver. 2.50 or later * <sup>1</sup>
---------------	---

#### IMPORTANT

- For GP3000 Series, GP-Pro EX Ver. 2.50 or later\*<sup>1</sup> is required to utilize the RGB unit. If you are currently using an earlier version of the above software, you will need to upgrade it. For more information, please contact your local Pro-face distributor.

\*<sup>1</sup>The software version information can be found on the [Help] menu's [Version Information] selection.

## Inquiry

Do you have any questions or comments about this product?  
Please access our website anytime if you need a help for the solution.

**<http://www.pro-face.com/otasuke/>**

When you visit the above website for the first time, please see the "Contact Pro-face" site for inquiry.

## UL/c-UL Approval

The RGB unit "GP3000-RGB201" is a UL/c-UL product, listed on UL File No.E220851 and UL File No.E210412.

The RGB unit "GP3000-RGB201" is a UL/c-UL product, recognized on UL File No.E171486 and UL File No.E231702.

Product Model No.	UL/c-UL Registration Model No.
GP3000-RGB201	3710013-01

The RGB unit "GP3000-RGB201" conforms to the following standards:

- UL508  
Standard for Industrial Control Equipment
- UL60950-1  
Information Technology Equipment - Safety - Part 1:General requirements
- ANSI/ISA-12.12.01-2007  
Nonincendive Electrical Equipment for Use in Class I and II, Division 2 and Class III, Division 1 and 2 Hazardous (classified) Locations.

### <Cautions>

Be aware of the following items when building the Display unit into an end-use product:

- Be sure that the unit is installed so that it is at least 100 mm away from any adjacent structures or devices. If these requirements are not met, the heat generated by the unit's internal components may cause the unit to fail to meet UL standard requirements.
- For use with the following models only: Models 3280024-02, -14; 3280035-41.
- For use with the following models only: Models 3280024-01, -11, -13; 3280035-45, -75; 3581301-01, -03.
- Receivable signals are only from isolated secondary source.
- RGB input interface circuitry is not intended to be directly connected to a source greater than 30 volts and the available current greater than 5 mA.

### <ANSI/ISA-12.12.01-2007 - Compliance and Handling Cautions>

- Suitable for use in Class I, Division 2, Groups A, B, C and D Hazardous Locations, or Non-Hazardous Locations.
- WARNING: Explosion hazard - substitution of components may impair suitability for Class I, Division 2.

- **WARNING:** Explosion hazard - when in hazardous locations, turn off power before replacing or wiring modules.
- **WARNING:** Explosion hazard - do not disconnect equipment unless power has been switched off or the area is known to be non-hazardous.

## **CE Marking**

The RGB unit "GP3000-RGB201" is a CE marked product that conforms to EMC directives, EN55011 Class A and EN61000-6-2.





# Table of Contents

Preface .....	1
Essential Safety Precautions .....	2
Information Symbols .....	4
Package Contents .....	4
Applicable Products .....	5
Inquiry .....	5
UL/c-UL Approval .....	6
CE Marking .....	7
Table of Contents .....	9
<b>Chapter 1 Overview</b>	
1.1 Operating the RGB Unit .....	11
1.2 System Configuration .....	11
1.2.1 Connection Configuration Diagram .....	11
1.3 Part Names and Functions .....	12
1.4 Unbundled Items .....	13
1.5 Software .....	13
<b>Chapter 2 Specifications</b>	
2.1 General Specifications .....	15
2.1.1 Electrical .....	15
2.1.2 Environmental .....	15
2.1.3 Structural .....	16
2.2 Performance Specifications .....	17
2.2.1 Performance Specifications .....	17
2.2.2 Interface Specifications .....	19
2.3 External View and Dimensions .....	21
2.3.1 External View .....	21
2.3.2 GP-3500 Series External View with the RGB Unit .....	22
2.3.3 GP-3600 Series External View with the RGB Unit .....	23
2.3.4 GP-3700 Series External View with the RGB Unit .....	24
<b>Chapter 3 Installation</b>	
3.1 Installing the RGB Unit .....	25
3.2 Wiring for RGB and USB Cable .....	27

3.2.1 RGB Cable Connection .....	27
3.2.2 USB Cable Connection .....	27

## Chapter 4 Setup

4.1 RGB IN0/1 Display Adjustment .....	31
4.2 Setup Mouse Emulation .....	31

## Chapter 1 Overview

### 1.1 Operating the RGB Unit

The RGB unit features the following functions:

- Maximum of 2 screens can be displayed on the Display unit among 2 PC image (RGB) inputs.
- Images on the Display unit are captured and saved on the CF card in JPEG files.

### 1.2 System Configuration

#### 1.2.1 Connection Configuration Diagram

The following diagram illustrates the connection.

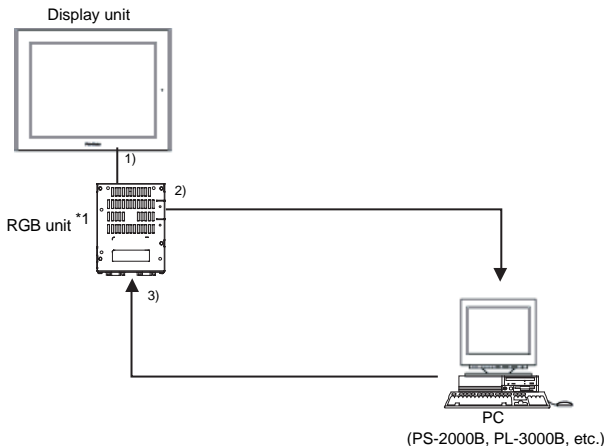

- |                    |   |
|--------------------|---|
| 1) VM BUS          | Connects to the Display unit rear face VM unit I/F            |
| 2) USB (0 to 1)    | Connect with a USB cable (optional or commercially available) |
| 3) RGB IN (0 to 1) | Connect with a RGB cable (optional or commercially available) |

\*1 The expansion unit cannot be installed in the Display unit expansion unit Interface (EXT1) if the RGB unit is installed in AGP-35\*0T.

## 1.3 Part Names and Functions

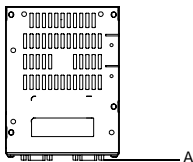

Front

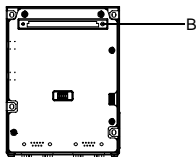

Rear

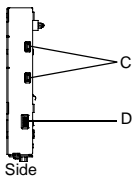

Side

- A. RGB IN (RGB0, RGB1)  
Connectors (2 ports) to input PC images.  
PC images of 2 systems (RGB0 and RGB1) can be input.
- B. Connecting port for Display unit  
Connector for the VM Unit Interface of Display unit.
- C. USB (mini-B type) (USB0, USB1)  
Connectors (2 ports) for mouse emulation.
- D. SW1  
System setting switch (Default ON)



Switch	Description	Setting
1	Reserved (always ON)	-
2	Reserved (always ON)	-
3	Reserved (always ON)	-
4	Reserved (always ON)	-

### IMPORTANT

- When performing mouse emulation, be aware of the following items.
  - Download the mouse emulation software (UPDD) from Pro-face website, "OtasukePro!" and install.  
<http://www.pro-face.com/otasuke/>
  - Connect to PC using USB0 and RGB0 or USB1 and RGB1 combination.

## 1.4 Unbundled Items

### ■ Cable

Product Name	Model No.	Description
RGB Cable	FP-CV02-45	RGB cable for outputting an image signal from the various hosts to the Display unit. (4.5m)
USB Cable	CA9-USBAMB/5M-01	USB cable for mouse emulation (5m)

### ■ Maintenance Items

Product Name	Model No.	Description
USB Cable Holder (mini-B)	CA9-USBATRGB/MB-01	USB cable retaining holder. (1 set)

## 1.5 Software

The RGB unit is compatible with GP-Pro EX Ver. 2.50 or later (GP3000 series).

Depending on your software version, it is necessary to download the latest module and install the additional programs.

For details, please access Pro-face's website "OtasukePro!" for product support.

<http://www.pro-face.com/otasuke/>

Refer to the "GP-Pro EX Reference Manual" for details on display settings for the input image window.



## Chapter 2 Specifications

### 2.1 General Specifications

#### 2.1.1 Electrical

Items		Specifications
Power Supply	Rated Voltage	DC5V $\pm$ 5% (supplied by the Display unit)
	Power Consumption	DC5V 0.8A (max.)
Voltage Endurance		DC type Display unit: AC1000V 20mA for 1 minute (between charging and FG terminals) AC type Display unit: AC1500V 20mA for 1 minute (between charging and FG terminals)
Insulation Resistance		DC500V 10M $\Omega$ (min.) (between charging and FG terminals)

#### 2.1.2 Environmental

Items		Specifications
Physical	Surrounding Air Temperature	0 to 50°C
	Storage Temperature	-20 to +60°C
	Ambient Humidity	10 to 90% RH (Wet bulb temperature: 39°C max. - no condensation.)
	Storage Humidity	10 to 90%RH (Wet bulb temperature: 39°C max. - no condensation.)
	Dust	0.1mg/m <sup>3</sup> and below (non-conductive levels)
	Pollution Degree	For use in Pollution Degree 2 environment
	Atmosphere	Free of corrosive gases
	Air Pressure Vibration Resistance (altitude range)	800 to 1114hPa (2000 meters above sea-level maximum)

Items		Specifications
Mechanical	Vibration Resistance	IEC61131-2 compliant 5 to 9Hz single-amplitude 3.5mm [0.14 in.] 9 to 150Hz constant-accelerated velocity 9.8m/s <sup>2</sup> X, Y, Z directions for 10 cycles (100 minutes)
	Concussion Resistance	IEC61131-2 compliant (147m/s <sup>2</sup> X, Y, Z directions for 3 times)
Electrical	Noise Immunity	Noise Voltage: 1000V <sub>p-p</sub> (Display unit: DC type) 1500V <sub>p-p</sub> (Display unit: AC type) Pulse Duration: 1μs Rise Time: 1ns (via noise simulator)
	Electrostatic Discharge Immunity	Contact Electrical Discharge 6kV (complies with IEC61000-4-2 Level 3)

### 2.1.3 Structural

Items		Specifications
Installation	Installation method	Screw fixing
	Cooling Method	Natural air circulation
	Weight	Approx. 400g [0.9lb] or less
	External Dimensions	W110mm [4.33in.] x H144mm [5.67in.] x D27mm [1.06in.] (excluding projection and connector part)



## 2.2 Performance Specifications

### 2.2.1 Performance Specifications

#### ■ RGB Input (RGB IN0/1)

Items	Specifications	Remarks
Signal System	VESA standard Analog RGB, separated	-
Maximum Transmission Distance	5m or less is recommended	Varies depending on the performance of the PC connected.
Display Colors	262,144 Colors	-
Resolution	See PC Signal input Screen Mode. <b>(SEE→)</b> ■ PC Signal Input Screen Mode (page18)	-
Color Signal	0.7V <sub>p-p</sub> , Positive polarity (TYP) Input range: 0.5 to 1.0V <sub>p-p</sub> , Positive polarity	75Ω termination resistor
Horizontal Sync.	TTL level, positive true / negative true	Signal polarity is determined automatically.
Vertical Sync.	TTL level, positive true / negative true	Signal polarity is determined automatically.
No. of Interface	2	-
Connector (Main Unit)	D-sub 15 pin (Socket)	-

## ◆ PC Signal Input Screen Mode

Mode	Horizontal Resolution	Vertical Resolution	H. Sync. (kHz)	V. Sync. (Hz)	Dot Clock (MHz)
VGA	640	480	31.469	59.940	25.175
	640	480	37.861	72.809	31.500
	640	480	37.500	75.000	31.500
	640	480	43.269	85.008	36.000
SVGA	800	600	35.156	56.250	36.000
	800	600	37.879	60.317	40.000
	800	600	48.077	72.188	50.000
	800	600	46.875	75.000	49.500
	800	600	53.674	85.061	56.250
XGA	1024	768	48.363	60.004	65.000
	1024	768	56.476	70.069	75.000
	1024	768	60.023	75.029	78.750

**NOTE**

Inputting the signal, the frequency of which deviates by more than  $\pm 5\%$  from the frequency listed above, may result in distortion of pictures.

## ■ USB

The PC recognizes the USB port as a virtual Com port.

Items	Specifications	Remarks
Communication baud rate	9600bps	
Data length	8 bit	
Parity bit	None	
Stop bit	1 bit	
Flow control	None	

## 2.2.2 Interface Specifications

### ■ RGB Input Interface

D-sub 15 pin connector for RGB Input

<Cable Side>

Recommended Cables	FP-CV02-45 (made by Pro-face)
--------------------	-------------------------------

### ◆ RGB connector Pin Assignments

Pin No.	Signal Name	I/O	Condition	Pin Assignment
1	RIN	I	Analog R	<p>The diagram shows a D-sub 15 pin connector with two locking screws at the top and bottom. The pins are arranged in a 3x5 grid. Pin 1 is at the bottom right, pin 5 is at the top right, pin 11 is at the bottom left, and pin 15 is at the top left.</p>
2	GIN	I	Analog G	
3	BIN	I	Analog B	
4	VGA_ID0	-	No connection	
5	AGND	-	Analog Ground	
6	RGND	-	Analog Ground	
7	GGND	-	Analog Ground	
8	BGND	-	Analog Ground	
9	PLUG	-	+5V	
10	GND	-	Ground	
11	VGA_ID2	-	No connection	
12	DDCSDA	I/O	DDC Data	
13	HSYNC	I	Analog Hsync	
14	VSYSNC	I	Analog Vsync	
15	DDCSCL	I	DDC Clock	

#### IMPORTANT

- Connect the cables before starting up the PC and the Display unit. To prevent possible equipment malfunction, do not disconnect the cable while the equipment is turned ON.
- If a cable other than the specified Pro-face RGB cable is used, the product performance cannot be guaranteed against possible noise or signal degradation.

## ■ USB Interface

USB connector for Mouse Emulation (mini-B)

<Cable Side>

Recommended Cables	CA9-USBAMB/5M-01 (made by Pro-face)
--------------------	-------------------------------------

### ◆USB connector Pin Assignments

Pin No.	Signal Name	I/O	Condition	Pin Assignment
1	Vbus	I	5V Detection	
2	-Data (D-)	I/O	USB Differential Signaling -	
3	+Data (D+)	I/O	USB Differential Signaling +	
4	ID	-	No connection	
5	GND	-	Ground	

#### IMPORTANT

- Connect the cables before starting up the PC and the Display unit. To prevent possible equipment malfunction, do not disconnect the cable while the equipment is turned ON.
- If a cable other than the specified Pro-face USB cable is used, the product performance cannot be guaranteed against possible noise or signal degradation.

## 2.3 External View and Dimensions

### 2.3.1 External View

Unit: mm [in.]

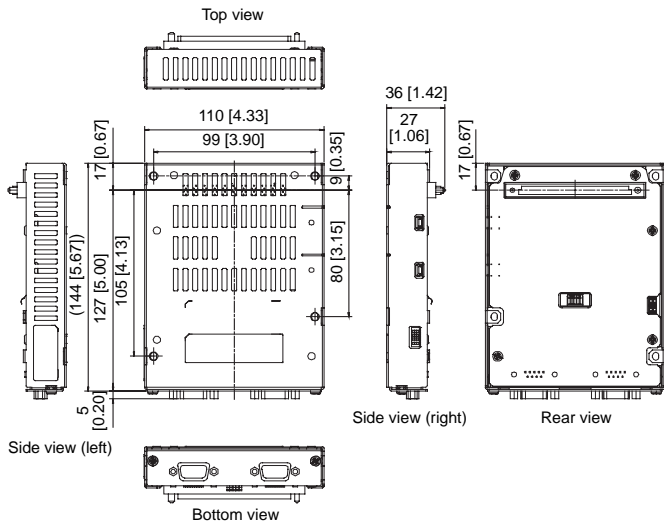

## 2.3.2 GP-3500 Series External View with the RGB Unit

Unit: mm [in.]

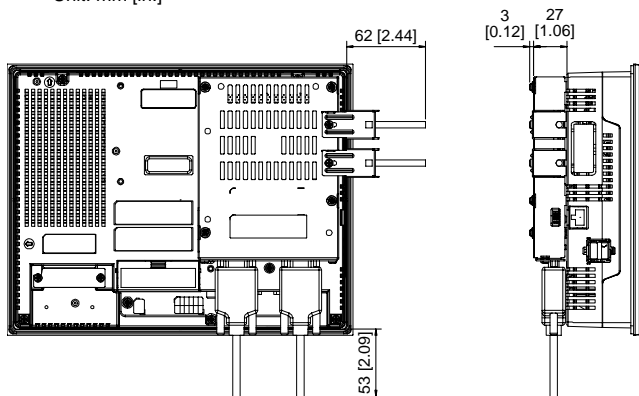
**NOTE**

- When you design the system, be sure to consider the cable material and the lead-out direction so that no excessive force is applied to the connector.

**IMPORTANT**

- All the above values are designed in case of cable bending. The dimensions given here are representative values depending on the type of connection cable used. Therefore, they are all intended for reference only.
- Be sure to design your system so that after the Display unit is installed there is sufficient space for the RGB unit's connectors and cable routing.
- When installing or removing the Display unit while its connectors attached, be sure not to damage any of the connectors.
- The Expansion Unit Interface 1 (EXT1) cannot be installed in the expansion unit when the RGB unit is installed in the AGP-35\*0T.

### 2.3.3 GP-3600 Series External View with the RGB Unit

Unit: mm [in.]

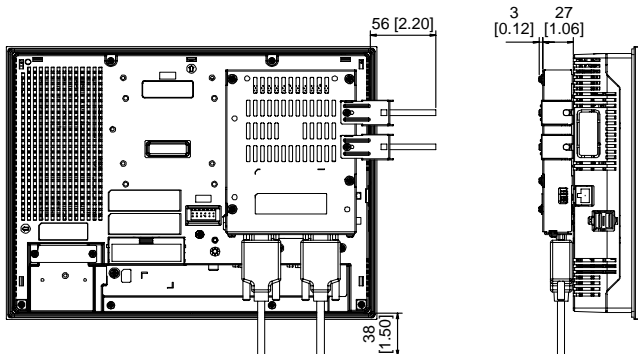

#### NOTE

- When you design the system, be sure to consider the cable material and the lead-out direction so that no excessive force is applied to the connector.

#### IMPORTANT

- All the above values are designed in case of cable bending. The dimensions given here are representative values depending on the type of connection cable used. Therefore, they are all intended for reference only.
- Be sure to design your system so that after the Display unit is installed there is sufficient space for the RGB unit's connectors and cable routing.
- When installing or removing the Display unit while its connectors attached, be sure not to damage any of the connectors.

## 2.3.4 GP-3700 Series External View with the RGB Unit

Unit: mm [in.]

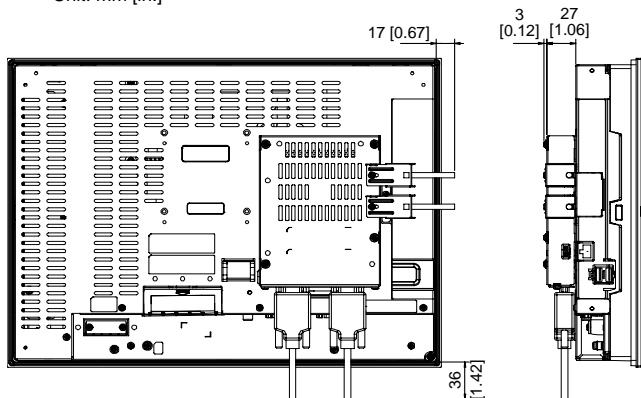
**NOTE**

- When you design the system, be sure to consider the cable material and the lead-out direction so that no excessive force is applied to the connector.

**IMPORTANT**

- All the above values are designed in case of cable bending. The dimensions given here are representative values depending on the type of connection cable used. Therefore, they are all intended for reference only.
- Be sure to design your system so that after the Display unit is installed there is sufficient space for the RGB unit's connectors and cable routing.
- When installing or removing the Display unit while its connectors are attached, be sure not to damage any of the connectors.



## Chapter 3 Installation

### 3.1 Installing the RGB Unit

---

**⚠ WARNING**

---

- ❗ To prevent an electric shock, before installation be sure to check that the Display unit's power cord is not plugged in to a power supply.

The following figure describes how to install the RGB unit into an AGP-3550T.

- (1) Disconnect the power cable from the Display unit and place the Display unit's face down on a flat horizontal surface.
- (2) Insert the connecting port for Display unit of the RGB unit into the VM Unit Interface on the rear face of the Display unit.

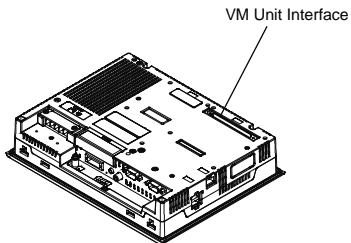

- (3) Fix the RGB unit with the four screws supplied. (Tightening torque: 0.5 to 0.6 N•m)

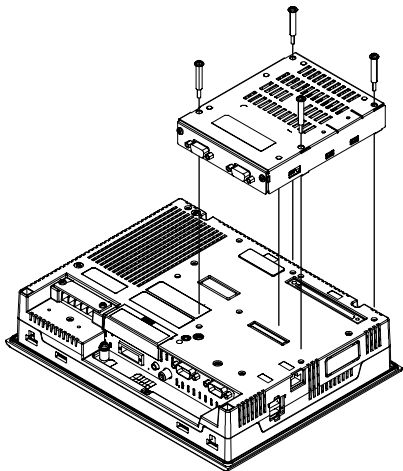
**IMPORTANT**

- The Expansion Unit Interface 1 (EXT1) cannot be installed in the expansion unit when the RGB unit is installed in the AGP-35\*0T.
- Because of the attaching screws' structure, there may be a gap between the screw heads and the RGB unit even when the RGB unit is securely fixed. Tightening the screws with too much force can damage their heads. Use the designated torque to tighten the screws.

## 3.2 Wiring for RGB and USB Cable

### 3.2.1 RGB Cable Connection

- (1) Make sure that power is not supplied to the Display unit and the PC.
- (2) Connect the RGB cable with the RGB IN0 or RGB IN1. The connector needs to be secured with a screw.

#### IMPORTANT

- Connect the cables before starting up the PC and the Display unit. To prevent possible equipment malfunction, do not disconnect the cables while the equipment is turned ON.
- Use a RGB cable with a connector of 18 mm (0.71 in.) or less in thickness. If the thickness is more than 18 mm (0.71 in.), it will interfere with the Display unit, and therefore cannot be connected.

### 3.2.2 USB Cable Connection

#### IMPORTANT

- When using the USB Interface in hazardous locations provided in the ANSI/ISA-12.12.01-2007, fix the USB cable with the USB cable holder. The USB Interface cannot be used in hazardous locations unless it is fixed so the connector does not come off.

#### ■ Installing the USB Cable Holder

- (1) Connect the USB cable with RGB unit.

#### NOTE

- The USB cable holder is compatible with the USB connector shell sizes indicated in the figure on the right.
- Connect to PC using USB0 and RGB0 or USB1 and RGB1 combination.

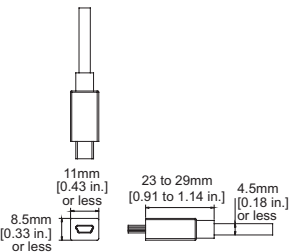

- (2) Insert the tab on the side of the USB holder into the RGB unit front slit on the USB cable side.

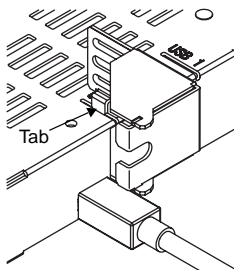

- (3) Lower the USB holder so as to face the USB cable.  
Pass the USB cable through the USB holder guide.

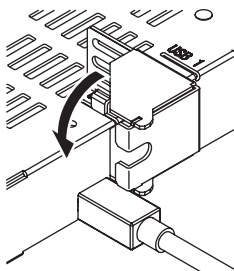

- (4) Adjust the USB holder so that it contacts the connector shell of the USB cable, and attach it with a USB holder fixing screw.

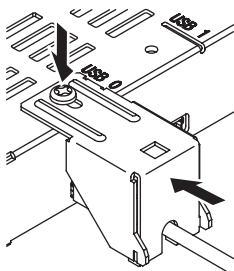

## ■ Removing the USB Cable Holder

Use step 2, 3, and 4 of the “Installing the USB cable holder” procedure in reverse order to remove the USB cable holder and disconnect the USB cable.

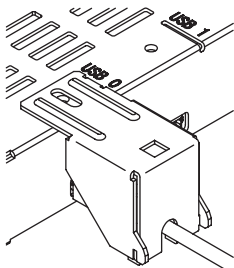

### IMPORTANT

- Turn the PC power off before removing the USB cable. Removal of the USB cable while the electricity is on may result in unstable PC operation. When the USB cable is unhooked, reboot the PC.



## Chapter 4 Setup

### 4.1 RGB IN0/1 Display Adjustment

When the image input into the RGB IN0 port is RGB IN1, the Display unit's position, screen and color can be adjusted in Display unit.  
Please refer to "Maintenance / Troubleshooting" of GP-Pro EX for the setup procedures.

### 4.2 Setup Mouse Emulation

To use the mouse emulation, the USB driver and the mouse emulation software (UPDD) need to be installed.  
The USB driver is included in the driver CD in the RGB unit's package.  
Download the UPDD from Pro-face website, "OtasukePro!"  
<http://www.pro-face.com/otasuke/>

#### ■ USB Driver Operating Environment

Windows® 2000, Windows® XP, Windows Vista®

**NOTE**

- Please verify the operating environment of mouse emulation software (UPDD) with Pro-face website, "OtasukePro!".

#### ■ Setup Procedure

(1) Connect the RGB unit to the PC using the USB cable.



*3.2.2 USB Cable Connection (page 27)*

(2) Install the USB driver that is included in the driver CD.

**NOTE**

- Depending on the environment, a message such as "Digital signature not found" (Windows 2000), "...has not passed Windows Logo testing to verify its compatibility with Windows XP." (Windows XP) or "Windows can't verify the publisher of this driver software" (Windows Vista), may be displayed when installing. There are no problems even when such a message is displayed, so please continue installation.

- (3) The installed USB driver operates as a virtual COM port. Make sure that "GP3000-RBG20x" is added to [Port (COM and LPT)] of the Device Manager.

Select the port number to which "GP3000-RBG20x" is assigned when installing UPDD.

**NOTE**

- Open the Device Manager from the control panel.

Windows 2000

From the [Control Panel], open [System], and click the [Hardware] tab.

Click [Device Manager] to display the Device Manager.

Windows XP

From the [Control Panel], open [Performance and Maintenance], and click [System].

From the [Hardware] tab, click [Device Manager] to display the Device Manager.

Windows Vista

From the [Control Panel], click [Hardware and Sound].

Click [Device Manager] to display the Device Manager.

- (4) Install the UPDD.

For instructions on how to install the UPDD, download the installation procedure from our website, "OtasukePro!"

**IMPORTANT**

- When installing the UPDD, when the [Select controller] is displayed, select "Digital, TSC-1310D Series Serial."
- When installing the UPDD, when the [Port] is displayed, select the port to which GP3000-RBG20x is assigned. The port can be checked with the Device Manager.