

MITSUBISHI

Analog-Digital Converter Module Type A616AD

User's Manual

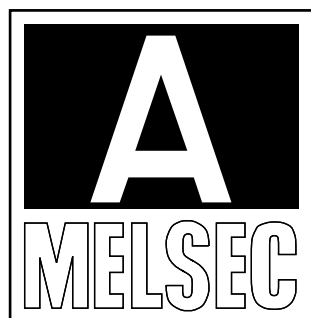
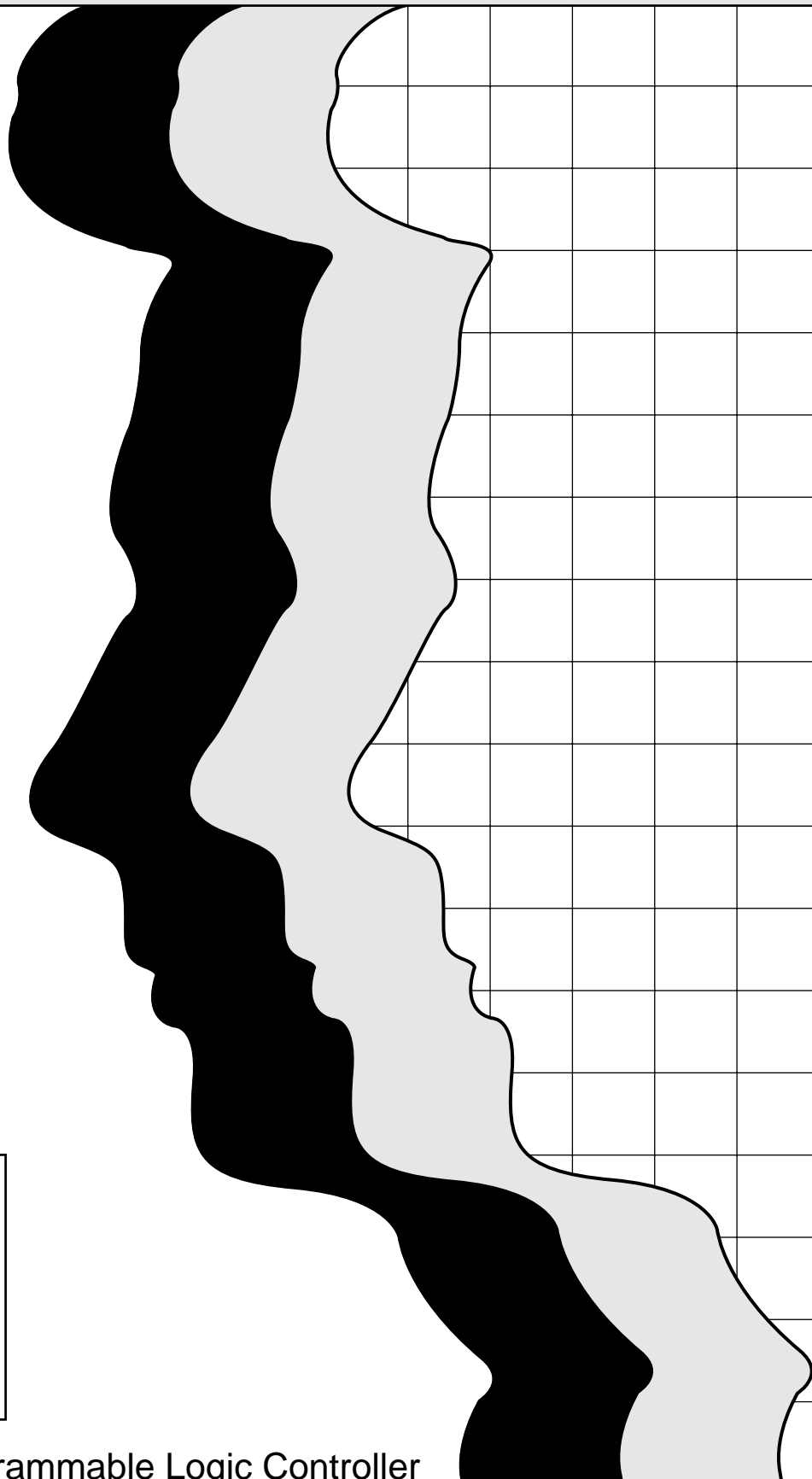

Mitsubishi Programmable Logic Controller



• SAFETY INSTRUCTIONS •

(Always read these instructions before using this equipment.)

Before using this product, please read this manual and the relevant manuals introduced in this manual carefully and pay full attention to safety to handle the product correctly.

The instructions given in this manual are concerned with this product only. For the safety instructions of the PLC system, please read the user's manual for the CPU module to use.

In this manual, the safety instructions are ranked as "DANGER" and "CAUTION".

 DANGER	Indicates that incorrect handling may cause hazardous conditions, resulting in death or severe injury.
 CAUTION	Indicates that incorrect handling may cause hazardous conditions, resulting in medium or slight personal injury or physical damage.

Note that the  CAUTION level may lead to a serious consequence according to the circumstances. Always follow the instructions of both levels because they are important to personal safety.

Please save this manual to make it accessible when required and always forward it to the end user.

[Designing Instructions]

 CAUTION
<ul style="list-style-type: none">• Do not bundle the control and communication cables with the main circuit, power and other cables, nor install them close to each other. They should be installed 100 mm or more away from each other. Not doing so can result in noise that would cause a malfunction.

[Mounting Instructions]

 CAUTION
<ul style="list-style-type: none">• Use the PLC in the environment that meets the general specifications given in this manual. Using the PLC in any environment outside the range of the general specifications can result in electric shock, fire, malfunction, or damage to or deterioration of the product.• Load the module after securely inserting the module fixing hook at the module bottom into the fixing hole of the base unit. Incorrect loading of the module can cause a malfunction, failure or drop.

[Wiring Instructions]

CAUTION

- Always ground the FG terminal to the protective conductor.
Not doing so can cause a malfunction.
- Before wiring the PLC, confirm the rated voltage and terminal arrangement of the product.
A fire or failure can occur if the power supply connected is different from the rating or wiring is incorrect.
- Tighten the terminal screws within the specified torque range.
Undertightening can cause a short circuit or malfunction.
Overtightening can cause a short circuit or malfunction due to damage of the screws or module.
- Ensure that foreign matters such as chips and wire off-cuts do not enter the module.
They can cause a fire, failure or malfunction.

[Setup/Maintenance Instructions]

CAUTION

- Do not touch the terminals while power is on.
Doing so can cause a malfunction.
- Be sure to shut off all phases of the external power supply before cleaning or retightening the terminal screws.
Not doing so can cause the module to fail or malfunction.
- Do not disassemble or modify the module.
Doing so can cause a failure, malfunction, injury or fire.
- Be sure to shut off all phases of the external power supply used by the system before mounting or removing the module.
Failure to do this may result in malfunction or damage to the module.
- Providing a voltage input to the current input range may lead to a failure.
- Before handling the module, always touch grounded metal, etc. to discharge static electricity from the human body.
Failure to do so can cause the module to fail or malfunction.

[Disposal Instructions]

CAUTION

- When disposing of the product, handle it as industrial waste.

REVISIONS

* The manual number is given on the bottom left of the back cover.

Print Date	* Manual Number	Revision
Dec., 1990	IB (NA)-66171-A	First edition
Nov., 1999	IB (NA)-66171-B	<p>Correction</p> <p>CONTENTS, Section 1.1, 2.1, 2.2, 2.3, 2.4, 3.3, 3.3.1, 3.3.2, 3.8, 3.9.1, 4.3.1, 4.6, 5.8, 5.9.1, 5.9.2</p> <p>Addition</p> <p>Section 4.3.1 Analog input select switch is short-circuit type</p>
Apr., 2001	IB (NA)-66171-C	<p>Correction</p> <p>Section 1.1, 2.2, 3.1, 3.2.1, 3.2.2, 3.2.3, 3.5, 4.2, 4.3.2, 4.3.3, 4.6.1, 5.5, 5.6, 5.9.1, 5.9.2</p> <p>Addition</p> <p>WARRANTY</p>
Mar., 2002	IB (NA)-66171-D	<p>Addition of Models</p> <p>A60MXRN</p> <p>Correction</p> <p>SAFETY INSTRUCTIONS, Section 1.1, 3.4.1, 3.4.2, 3.7, 4.3.2, 4.3.3, 4.4.3, 4.4.4, 5.1, 5.9.1</p> <p>Addition</p> <p>Section 3.2.4, 4.3.4, Appendix 1</p>
Nov., 2004	IB (NA)-66171-E	<p>Correction</p> <p>SAFETY INSTRUCTIONS, Section 2.3, 3.1, 4.2, 4.3.1, 4.4.1, WARRANTY</p>

Japanese Manual Version IB-68078-L

This manual confers no industrial property rights or any rights of any other kind, nor does it confer any patent licenses. Mitsubishi Electric Corporation cannot be held responsible for any problems involving industrial property rights which may occur as a result of using the contents noted in this manual.

INTRODUCTION

Thank you for choosing the Mitsubishi MELSEC-A Series of General Purpose Programmable Controllers. Please read this manual carefully so that the equipment is used to its optimum. A copy of this manual should be forwarded to the end User.

1. INTRODUCTION

2. SYSTEM CONFIGURATION

3. SPECIFICATIONS

4. PRE-OPERATION SETTINGS AND PROCEDURES

5. PROGRAMMING

6. TROUBLESHOOTING

APPENDICES

CONTENTS

1. INTRODUCTION	1-1 ~ 1-3
1.1 Features	1-2
2. SYSTEM CONFIGURATION	2-1 ~ 2-5
2.1 Overall Configuration	2-1
2.2 Notes on Use of A616AD in System	2-3
2.3 Notes on Configuring a System	2-4
2.4 Module Connection	2-5
3. SPECIFICATIONS	3-1 ~ 3-22
3.1 General Specifications	3-1
3.2 Performance Specifications	3-2
3.2.1 A616AD performance list	3-2
3.2.2 A60MX performance list	3-3
3.2.3 A60MXR performance list	3-4
3.2.4 A60MXRN performance list	3-5
3.3 A616AD I/O Characteristics	3-6
3.3.1 Voltage input characteristics	3-6
3.3.2 Current input characteristics	3-8
3.4 A60MX/A60MXR/A60MXRN I/O Characteristics	3-8
3.4.1 Voltage input characteristics	3-9
3.4.2 Current input characteristics	3-11
3.5 Overall Accuracy	3-13
3.6 A/D Conversion	3-14
3.6.1 Sampling processing	3-14
3.6.2 Direct access processing	3-14
3.7 Maximum Conversion Speed	3-15
3.8 Processing Timing	3-17
3.9 Function Block Diagrams	3-19
3.9.1 A616AD function block diagram	3-19
3.9.2 A60MX function block diagram	3-20
3.9.3 A60MXR function block diagram	3-21
3.10 Useful Life of the A60MXR Mercury-Plunger Relay	3-22
4. PRE-OPERATION SETTINGS AND PROCEDURES	4-1 ~ 4-20
4.1 Pre-Operation Settings and Procedures	4-1
4.2 Handling Instructions	4-2
4.3 Nomenclature	4-3
4.3.1 A616AD	4-3
4.3.2 A60MX	4-7
4.3.3 A60MXR	4-9
4.3.4 A60MXRN	4-11
4.4 Offset/Gain Microadjustment	4-13
4.4.1 A616AD offset/gain microadjustment procedure	4-13
4.4.2 A60MX/A60MXR offset/gain microadjustment procedure	4-14
4.4.3 Offset microadjustment	4-15
4.4.4 Gain microadjustment	4-17

4.5	Wiring Instructions	4-19
4.6	Module Connection Examples	4-19
4.6.1	Wiring examples for A616AD used alone	4-19
4.6.2	Wiring example for A616AD used with A60MX/A60MXR	4-20

5. PROGRAMMING 5-1 ~ 5-21

5.1	I/O List for PLC CPU	5-1
5.2	Buffer Memory	5-3
5.2.1	Buffer memory assignment	5-3
5.3	Programming Procedure	5-4
5.4	Initial Setting	5-4
5.4.1	Setting the sampling period	5-5
5.4.2	Setting the data format	5-6
5.4.3	Specifying A/D conversion enable/disable	5-7
5.4.4	Set data setting request	5-8
5.5	Reading the Sampling Processing Output Values	5-9
5.6	Reading the Direct Access Processing Output Value	5-12
5.7	Reading the Error Code	5-14
5.8	Clearing the Error Code Area	5-14
5.9	Programming for ACPURemote I/O Station	5-15
5.9.1	Programming instructions	5-15
5.9.2	Basic programs for read and write	5-17

6. TROUBLESHOOTING 6-1 ~ 6-11

6.1	Error Code List	6-1
6.2	Troubleshooting	6-2
6.2.1	General troubleshooting	6-2
6.2.2	"RUN" LED flickering	6-3
6.2.3	"RUN" LED off	6-3
6.2.4	CPU module in "SP. UNIT DOWN" error	6-4
6.2.5	CPU module in "SP. UNIT ERROR"	6-4
6.2.6	CPU module in "CONTROL-BUS ERR."	6-4
6.2.7	READY signal (X1) remains off	6-4
6.2.8	WDT error signal (X0) on	6-5
6.2.9	Error code in special register D9008	6-5
6.2.10	Digital value unreadable from CPU	6-6
6.2.11	Analog and digital value mismatch	6-7
6.2.12	Sudden digital value change	6-7
6.2.13	Constant digital value deviation from reference value	6-8
6.2.14	Error code indicated on LED display	6-9
6.2.15	Error code "02" indicated on LED display	6-10
6.2.16	Checking A616AD, A60MX/A60MXR hardware fault	6-11
6.2.17	A616AD, A60MX/A60MXR hardware fault	6-11

APPENDICES APP-1 ~ APP-3

Appendix 1	Precautions for Replacing A60MXR with A60MXRN	APP-1
Appendix 2	A616AD Dimensions	APP-2
Appendix 3	A60MX/A60MXR Dimensions	APP-3

Conformation to the EMC Directive and Low Voltage Instruction

For details on making Mitsubishi PLC conform to the EMC directive and low voltage instruction when installing it in your product, please see Chapter 3, "EMC Directive and Low Voltage Instruction" of the User's Manual (Hardware) of the PLC CPU to use.

The CE logo is printed on the rating plate on the main body of the PLC that conforms to the EMC directive and low voltage instruction.

By making this product conform to the EMC directive and low voltage instruction, it is not necessary to make those steps individually.

1. INTRODUCTION

This manual gives specifications, handling, programming procedures, etc. for the A616AD analog-digital converter module for use with the MELSEC-A series CPU module.

When connected with the A60MX non-isolated multiplex module (hereafter abbreviated to the A60MX), A60MXR isolated multiplex module (hereafter abbreviated to the A60MXR) or A60MXRN analog I/P multiplexer (channel isolated) (hereafter abbreviated to the A60MXRN), the A616AD can increase channels. (The A60MXR and A60MXRN are hereafter abbreviated generically to the A60MXR. Note that if specifications differ between the A60MXR and A60MXRN, the specifications of the A60MXR and A60MXRN are described separately.)

The A60MX/A60MXR outputs the converted value to the A616AD channels which are switched from one to another at given intervals.

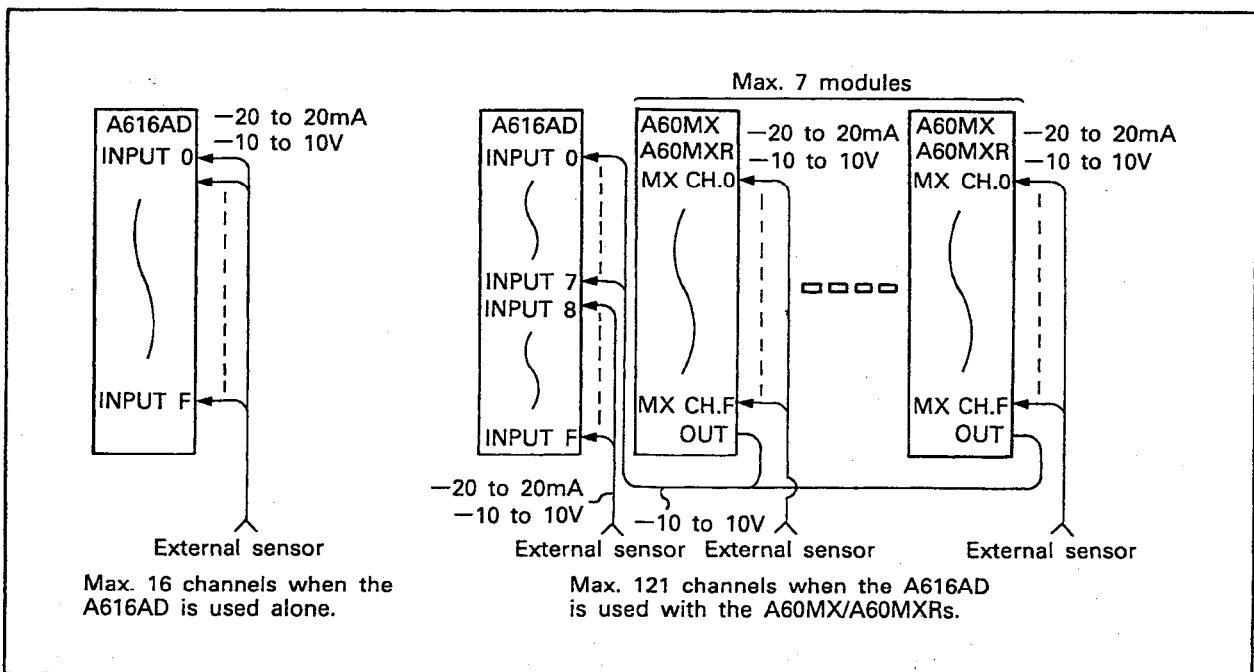

1.1 Features

- (1) When the A616AD is used alone, external sensors can be connected with up to 16 channels.
- (2) The number of channels can be increased to a maximum of 121 by connecting the A60MX/A60MXR to channels 0 to 7 of the A616AD.
The conversion time of all channels is $1\text{ms} \times \text{number of channels}$.
- (3) Voltage or current input may be selected for every channel of the A616AD, A60MX and A60MXR.
- (4) Channels can be isolated by using the A60MXR.
- (5) In addition to the sampling processing mode which executes A/D conversion for channels switched from one to another per sampling period, the direct access processing is available mode which allows direct A/D conversion for the channel specified by the program.
- (6) A/D conversion enable/disable can be defined per channel so that the sampling time may be reduced by disabling unused channels from A/D conversion.

In this manual, the CPU types are generally referred to as follows:

(1) Sequencer CPU

A1CPU(P21/R21)	A2UCPU
A2CPU(P21/R21)	A2UCPU-S1
A2CPU-S1(P21/R21)	A3UCPU
A3CPU(P21/R21)	A4UCPU
A1NCPU(P21/R21)	A73CPU(P21/R21)
A2NCPU(P21/R21)	A3MCPU(P21/R21)
A2NCPU-S1(P21/R21)	A81CPU
A3NCPU(P21/R21)	Q2ACPU
A3HCPU(P21/R21)	Q2ACPU-S1
A2ACPU(P21/R21)	Q3ACPU
A2ACPU-S1(P21/R21)	Q4ACPU
A3ACPU(P21/R21)	Q4ARCPU
A0J2CPU(P23/R23)	
A0J2HCPU(P21/R21)	
A52GCPU(T21B)	

(2) Building block type CPU

A1CPU(P21/R21)	A2UCPU
A2CPU(P21/R21)	A2UCPU-S1
A2CPU-S1(P21/R21)	A3UCPU
A3CPU(P21/R21)	A4UCPU
A1NCPU(P21/R21)	A73CPU(P21/R21)
A2NCPU(P21/R21)	A3MCPU(P21/R21)
A2NCPU-S1(P21/R21)	A81CPU
A3NCPU(P21/R21)	Q2ACPU
A3HCPU(P21/R21)	Q2ACPU-S1
A2ACPU(P21/R21)	Q3ACPU
A2ACPU-S1(P21/R21)	Q4ACPU
A3ACPU(P21/R21)	Q4ARCPU

(3) Compact-type CPU

A0J2CPU(P23/R23)
A0J2HCPU(P21/R21)
A52GCPU(T21B)

2. SYSTEM CONFIGURATION

2. SYSTEM CONFIGURATION

2.1 Overall Configuration

(1) System using the A616AD with building block type CPU

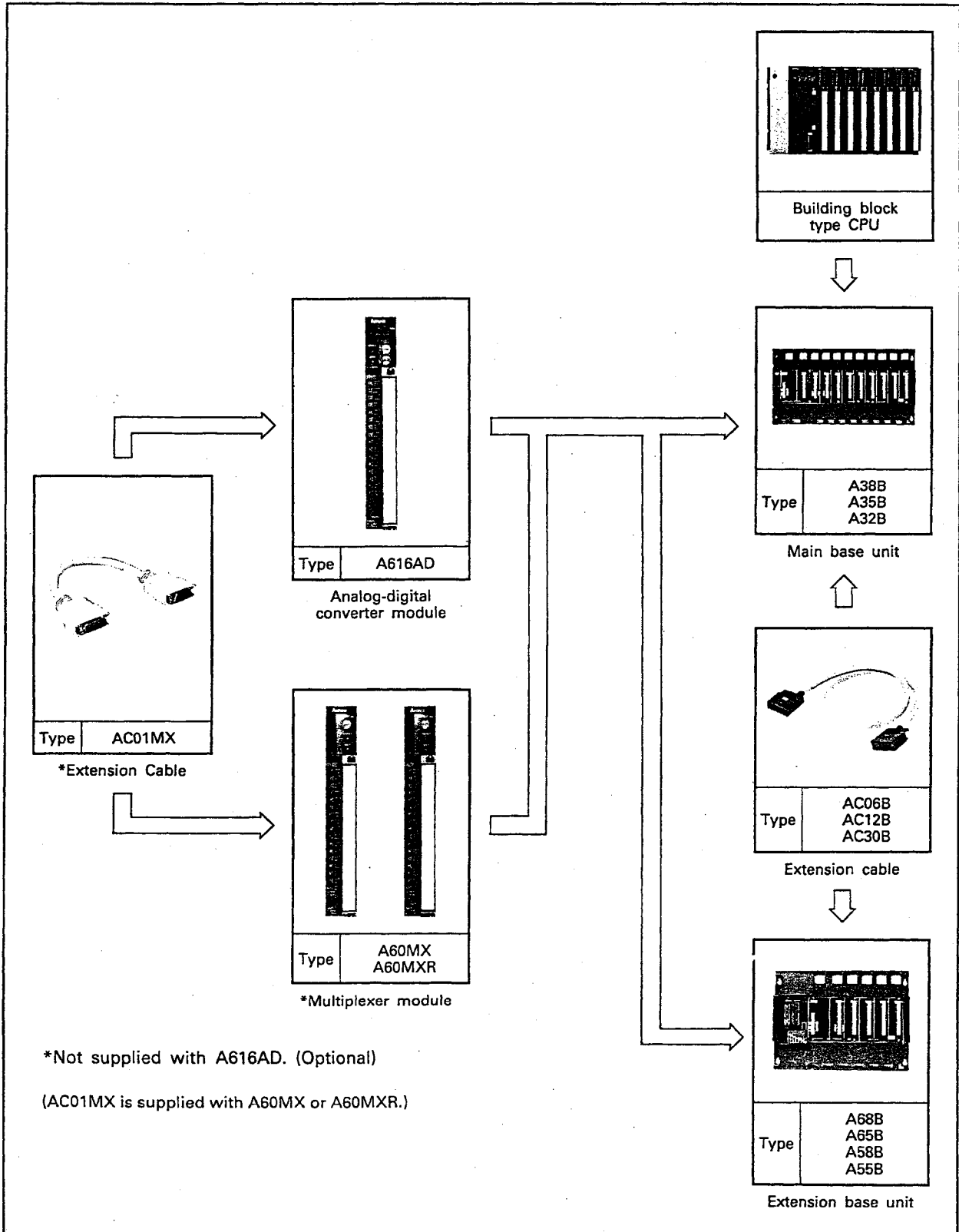

(2) System using the A616AD with compact CPU

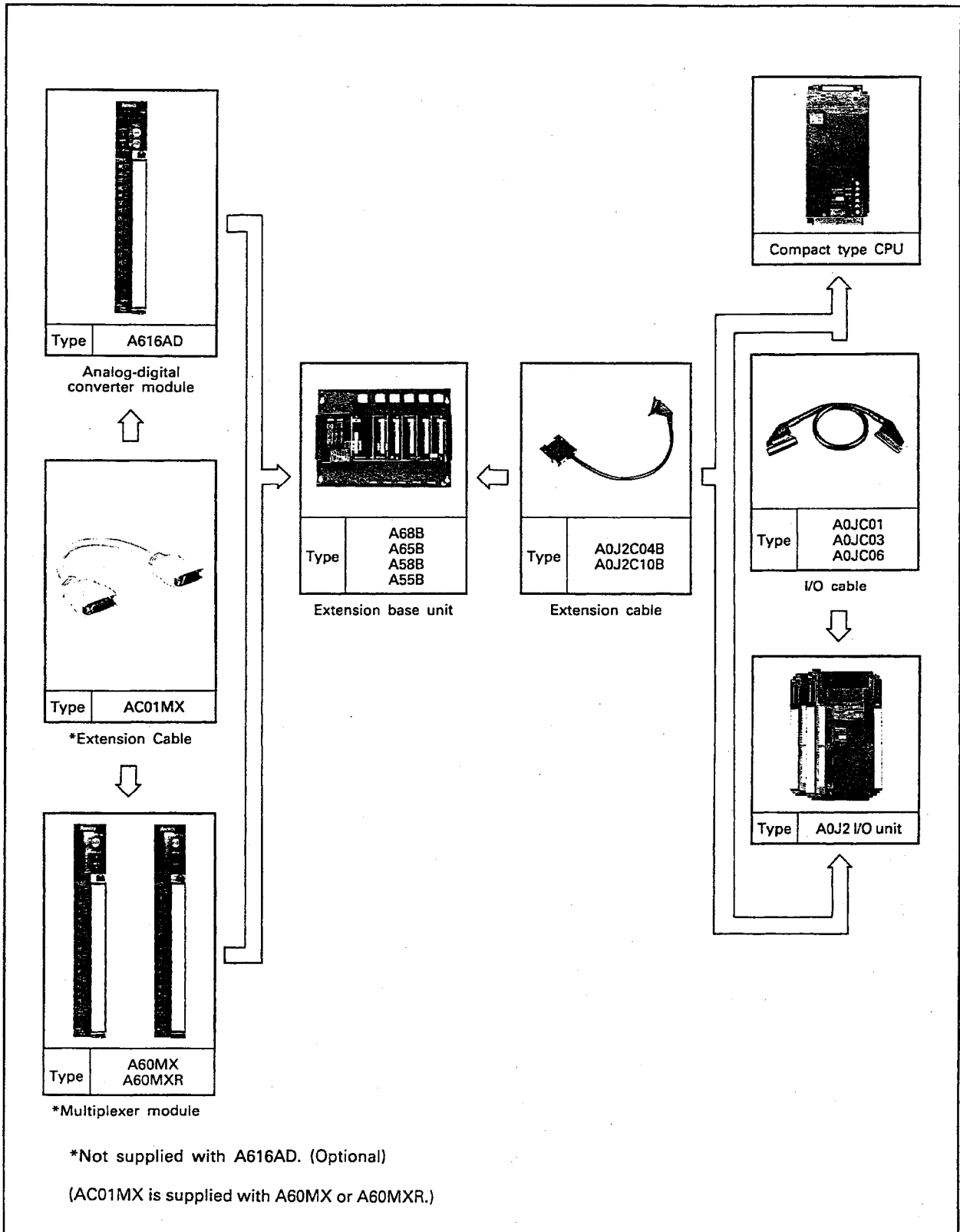

2.2 Notes on Use of A616AD in System

The A616AD is applicable to any of the following CPU modules.

Applicable CPU modules		
A0J2CPU	A3UCPU	A1SJCPU(S3)
A0J2HCPU	A4UCPU	A1SJHCPU(S8)
A1NCPUCPU	A73CPU	A1SCPU(S1)
A2NCPUCPU	A81CPU	A1SCPUC24-R2
A2NCPUCPU-S1	A1CPU	A1SHCPU
A3NCPUCPU	A2CPU	A2SCPU(S1)
A3HCPUCPU	A2CPU-S1	A2SHCPU(S1)
A3MCPUCPU	A3CPU	A2ACPU(S1/S30)
A2ACPU	Q2ACPU	A2USHCPU-S1
A2ACPU-S1	Q2ACPU-S1	Q2ASCPU(S1)
A3ACPU	Q3ACPU	Q2ASHCPU(S1)
A2UCPU	Q4ACPU	A52GCPUCPU
A2UCPU-S1	Q4ARCPUCPU	

The A616AD can be loaded into any slot of the base unit with the exception of the following, and there are no restrictions on the number of modules loaded.

- (1) Where possible, avoid loading the A616AD into the extension base without power supply module (A511 extension base unit) since there is a probability of insufficient power supply capacity. When loading, fully consider the power supply capacity of the main base unit and the voltage drop of the extension cable to select the power supply module and extension cable. (For details, refer to the corresponding CPU user's manual.)
- (2) When the A3CPU (P21/R21) is used, it cannot be loaded into the last slot of the seventh extension base unit.
(These restrictions do not apply to A3NCPUCPU, A3HCPUCPU, A3MCPUCPU, A73CPU, A3ACPU.)
- (3) On a data link system, the A616AD can be mounted to any of the following: master station, local station or remote I/O station. Refer to the MELSECNET, MELSECNET/B data link system reference manual for examples of programs for remote I/O stations.

POINT

The A616AD cannot be loaded and used in the A0J2P25/R25 (remote I/O station).

2.3 Notes on Configuring a System

- (1) The A60MX/A60MXR cannot be used independently.
Up to seven modules may be loaded by connecting the OUT terminal of the A60MX/A60MXR with any of the A616AD INPUT channels 0 to 7.
- (2) The A60MX/A60MXR must be loaded on the base which accommodates the A616AD and connected by using the original cable (AC01MX).
Any module other than the A60MX/A60MXR cannot be loaded between the A616AD and A60MX/A60MXR.
- (3) Direct access processing is disabled if the A616AD is loaded on a remote I/O station.
- (4) Offset/gain adjustment may be made for all 16 channels, not for individual channels.
- (5) Although the A616AD and A60MX are not isolated between channels, 1M Ω resistor isolation keeps influence between channels at the minimum value.
To completely isolate the channels, use the A60MXR and enter external sensor signals to the A60MXR channels.
- (6) The inter-channel dielectric withstand voltage of the A60MXR is 500VDC (accuracy guarantee 500VDC) and that of the A60MXRN is 400VDC (accuracy guarantee 400VDC).
- (7) When any I/O characteristic is selected by offset/gain setting, the overall accuracy of the A616AD, A60MX and X60MXR remains unchanged and is kept within the range indicated in the performance list.
- (8) The A616AD may only be loaded to the first four slots of the extension base unit used with the A0J2CPU.
- (9) When using the A60MXR, never install the module horizontally or vertically. If it is installed in such a way, the internal mercury relay may not operate properly.
When the A60MXRN is used, there are no restrictions on mounting.
- (10) The A616AD has been preset to "S1"(analog input range 0 to 10V) by the offset/gain setting pin prior to shipment.
When using a different analog input range, change the preset range to the desired one by the offset/gain setting pin and make the offset/gain adjustment.

2. SYSTEM CONFIGURATION



2.4 Module Connection

The number of channels can be increased by connecting the A616AD with the A60MX/A60MXR. The modules may be connected as shown below:

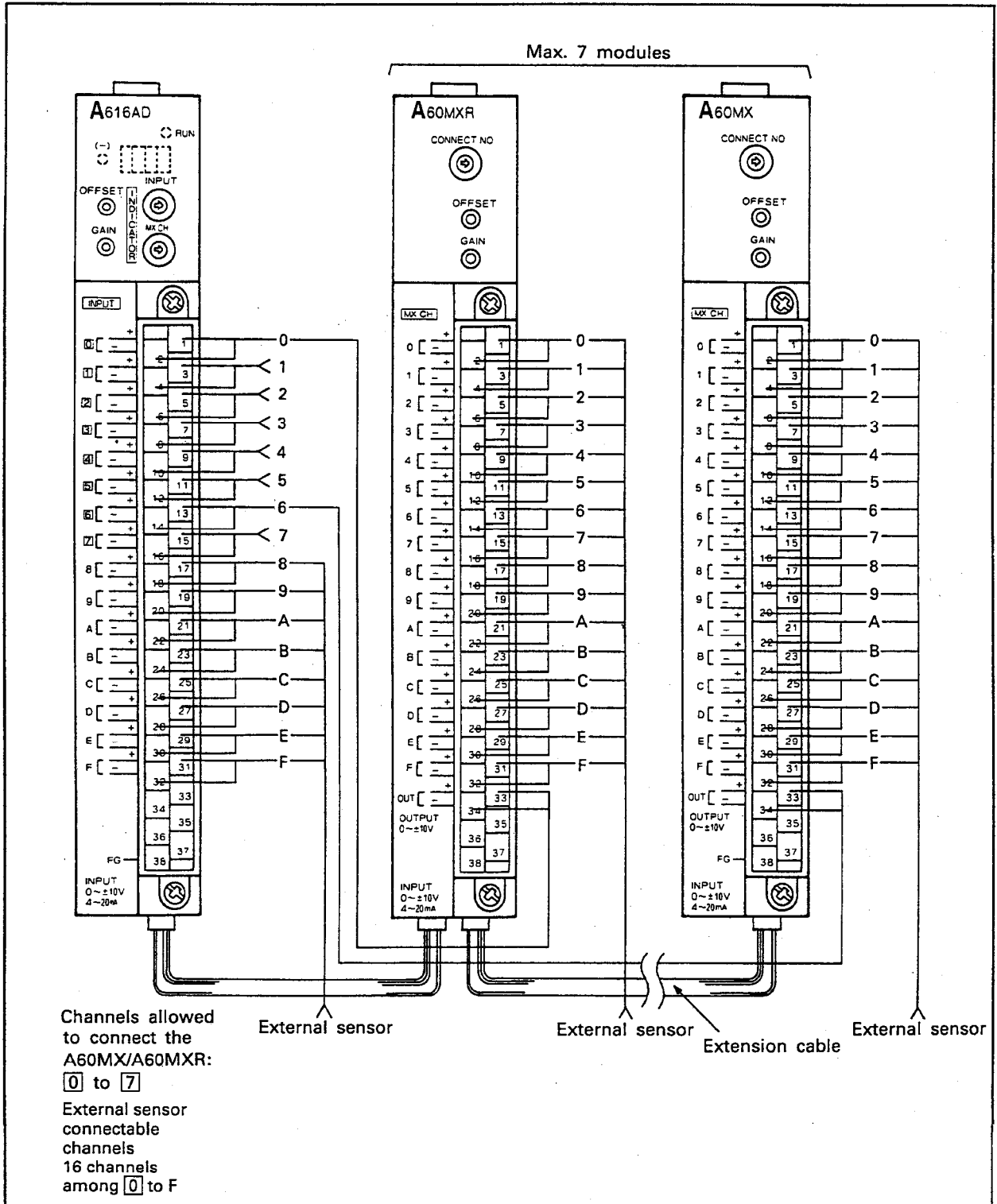

3. SPECIFICATIONS



3. SPECIFICATIONS

3.1 General Specifications

Table 3.1 shows the common specifications of various units used.

Item	Specifications					
Operating ambient temperature	0 to 55°C					
Storage ambient temperature	-20 to 75°C					
Operating ambient humidity	10 to 90%RH, non-condensing					
Storage ambient humidity	10 to 90%RH, non-condensing					
Vibration resistance	Conforming to JIS B 3502, IEC 61131-2	Under intermittent vibration	Frequency	Acceleration	Amplitude	Sweep count 10 times each in X, Y, Z directions (for 80 min.)
			10 to 57 Hz	—	0.075 mm (0.003 in.)	
		57 to 150 Hz	9.8m/s ²	—		
		Under continuous vibration	Frequency	Acceleration	Amplitude	
10 to 57 Hz	—	0.035 mm (0.001 in.)				
57 to 150 Hz	4.9m/s ²	—				
Shock resistance	Conforming to JIS B 3502, IEC 61131-2 (147m/s ² , 3 times each in X, Y, Z directions)					
Noise durability	By noise simulator of 1500Vpp noise voltage, 1 μs noise width and 25 to 60Hz noise frequency					
Dielectric withstand voltage	1500V AC for 1 minute across AC external terminals and ground 500V AC for 1 minute across DC external terminals and ground					
Insulation resistance	5MΩ or larger by 500V DC insulation resistance tester across AC external terminals and ground					
Grounding	Grounding is required; it is not required when it is impossible.					
Operating ambience	No corrosive gas					
Operating height *3	2000 m (6562 ft.) max.					
Installation location	Inside the control panel					
Overvoltage category *1	II or less					
Pollution rate *2	2 or less					
Cooling method	Self-cooling					

Table 3.1 General Specifications

*1: Indicates the distribution area where the device is assumed to be connected, from the public power distribution network to the local machine device.
Category II is applied to the devices to which the power is supplied from a fixed equipment.
The surge resistance voltage of a rated 300 V device is 2500 V.

*2: This is an index which indicates the occurrence rate of the conductive object in the environment where the device is used.
Pollution rate II indicates that only non-conductive pollution may occur with a possibility of generating temporary conductivity due to accidental condensation.

*3: Do not use or store the PLC under pressure higher than the atmospheric pressure of altitude 0m.
Doing so can cause a malfunction.
When using the PLC under pressure, please contact your sales representative.

3. SPECIFICATIONS



3.2 Performance Specifications

This section explains the performance specifications of the A616AD, A60MX, A60MXR and A60MXRN.

3.2.1 A616AD performance list

Table 3.2 lists the performance capabilities of the A616AD.

Item		Specifications	Refer To																																
Analog input	Voltage (V)	-10 to +10 DC (Input resistance:1M Ω)	—																																
	Current (mA)	-20 to +20 DC (Input resistance:250 Ω)																																	
Digital output		16-bit (data part: 12 bits) signed binary (-48 to 4047, -2048 to +2047). May be set per channel.	Section 5.4.2																																
I/O characteristics Maximum resolution		<table border="1"> <thead> <tr> <th>Input</th> <th>Analog input range</th> <th>Maximum resolution</th> <th>Digital output value</th> </tr> </thead> <tbody> <tr> <td rowspan="5">Voltage (V)</td> <td>0 to +10</td> <td>2.5mV (1/4000)</td> <td rowspan="5">0 to 4000 -2000 to 2000</td> </tr> <tr> <td>0 to +5</td> <td>1.25mV (1/4000)</td> </tr> <tr> <td>+1 to +5</td> <td>1.0mV (1/4000)</td> </tr> <tr> <td>-10 to +10</td> <td>5.0mV (1/4000)</td> </tr> <tr> <td>-5 to +5</td> <td>2.5mV (1/4000)</td> </tr> <tr> <td rowspan="5">Current (mA)</td> <td>0 to +20</td> <td>10μA (1/2000)</td> <td>0 to 2000 -2000 to 0</td> </tr> <tr> <td>0 to +20</td> <td>5μA (1/4000)</td> <td>0 to 4000</td> </tr> <tr> <td>+4 to +20</td> <td>4μA (1/4000)</td> <td>-2000 to 2000</td> </tr> <tr> <td>-20 to +20</td> <td>20μA (1/2000)</td> <td>1000 to 3000 -1000 to 1000</td> </tr> <tr> <td>-20 to +20</td> <td>10μA (1/4000)</td> <td>0 to 4000 -2000 to 2000</td> </tr> </tbody> </table>	Input	Analog input range	Maximum resolution	Digital output value	Voltage (V)	0 to +10	2.5mV (1/4000)	0 to 4000 -2000 to 2000	0 to +5	1.25mV (1/4000)	+1 to +5	1.0mV (1/4000)	-10 to +10	5.0mV (1/4000)	-5 to +5	2.5mV (1/4000)	Current (mA)	0 to +20	10 μ A (1/2000)	0 to 2000 -2000 to 0	0 to +20	5 μ A (1/4000)	0 to 4000	+4 to +20	4 μ A (1/4000)	-2000 to 2000	-20 to +20	20 μ A (1/2000)	1000 to 3000 -1000 to 1000	-20 to +20	10 μ A (1/4000)	0 to 4000 -2000 to 2000	Section 3.3
Input	Analog input range	Maximum resolution	Digital output value																																
Voltage (V)	0 to +10	2.5mV (1/4000)	0 to 4000 -2000 to 2000																																
	0 to +5	1.25mV (1/4000)																																	
	+1 to +5	1.0mV (1/4000)																																	
	-10 to +10	5.0mV (1/4000)																																	
	-5 to +5	2.5mV (1/4000)																																	
Current (mA)	0 to +20	10 μ A (1/2000)	0 to 2000 -2000 to 0																																
	0 to +20	5 μ A (1/4000)	0 to 4000																																
	+4 to +20	4 μ A (1/4000)	-2000 to 2000																																
	-20 to +20	20 μ A (1/2000)	1000 to 3000 -1000 to 1000																																
	-20 to +20	10 μ A (1/4000)	0 to 4000 -2000 to 2000																																
Overall accuracy (%) (Accuracy to full scale)		A616AD used alone <table> <tr> <td>0 to 10V, -10 to 10V</td> <td rowspan="2">} range: $\pm 0.3\%$ (Digital output value ± 12)</td> </tr> <tr> <td>-5 to 5V, -20V to 20mA</td> </tr> <tr> <td>0 to 5V, 1 to 5V</td> <td rowspan="2">} range: $\pm 0.6\%$ (Digital output value ± 24)</td> </tr> <tr> <td>0 to 20mA, 4 to 20mA</td> </tr> </table> A616AD used with A60MX/A60MXR/A60MXRN Accuracy of each A616AD range $\pm 0.3\%$ (Digital output value ± 12)	0 to 10V, -10 to 10V	} range: $\pm 0.3\%$ (Digital output value ± 12)	-5 to 5V, -20V to 20mA	0 to 5V, 1 to 5V	} range: $\pm 0.6\%$ (Digital output value ± 24)	0 to 20mA, 4 to 20mA	Section 3.5																										
0 to 10V, -10 to 10V	} range: $\pm 0.3\%$ (Digital output value ± 12)																																		
-5 to 5V, -20V to 20mA																																			
0 to 5V, 1 to 5V	} range: $\pm 0.6\%$ (Digital output value ± 24)																																		
0 to 20mA, 4 to 20mA																																			
Max. conversion speed (ms/channel)		A616AD used alone: 1 A616AD used with A60MX: 1 A616AD used with A60MXR: 1 (sampling processing), 7.0 (direct access processing) A616AD used with A60MXRN: 1 (sampling processing), 7.0 (direct access processing)	Section 3.6 Section 3.7																																
Max. absolute input	Voltage (V)	± 15	—																																
	Current (mA)	± 30																																	
Number of analog input points		16 channels/module	—																																
Isolation		Between input terminals and PLC: Photocoupler isolation Between channels: Non-isolated (1M Ω resistor isolation)	—																																
Number of I/O points occupied		32	—																																
Terminals connected		38-point terminal block	—																																
Applicable wire size		0.75 to 2mm ² (18 to 14 AWG) (applicable tightening torque: 39 to 59 N·cm)	—																																
Applicable solderless terminal		V1.25-3, V1.25-YS3A, V2-S3, V2-YS3A	—																																
Internal current consumption (A) 5V DC		1	—																																
Weight (kg)		0.85	—																																

Table 3.2 A616AD Performance List

3. SPECIFICATIONS



3.2.2 A60MX performance list

Table 3.3 lists the performance capabilities of the A60MX.

Item		Specifications	Refer To																																		
Analog input	Voltage (V)	-10 to +10 DC (Input resistance:1M Ω)	—																																		
	Current (mA)	-20 to +20 DC (Input resistance:250 Ω)																																			
Analog output voltage (V)		-10 to +10 DC	—																																		
I/O characteristics	<table border="1"> <thead> <tr> <th colspan="2">Analog input range</th> <th rowspan="2">Digital output voltage (V)</th> </tr> <tr> <th>Voltage (V)</th> <th>Current (mA)</th> </tr> </thead> <tbody> <tr> <td>0 to +10</td> <td>0 to +20</td> <td rowspan="5">0 to +10</td> </tr> <tr> <td>0 to +5</td> <td>0 to +20</td> </tr> <tr> <td>+1 to +5</td> <td>+4 to +20</td> </tr> <tr> <td>-10 to +10</td> <td>-20 to +20</td> </tr> <tr> <td>-5 to +5</td> <td>-20 to +20</td> </tr> <tr> <td>0 to +10</td> <td>0 to +20</td> <td rowspan="2">0 to +5</td> </tr> <tr> <td>0 to +5</td> <td>0 to +20</td> </tr> <tr> <td>+1 to +5</td> <td>+4 to +20</td> <td>+1 to +5</td> </tr> <tr> <td>-10 to +10</td> <td>-20 to +20</td> <td>-10 to +10</td> </tr> <tr> <td>-5 to +5</td> <td>-20 to +20</td> <td rowspan="2">-5 to +5</td> </tr> <tr> <td>-10 to +10</td> <td>-20 to +20</td> </tr> <tr> <td>-5 to +5</td> <td>-20 to +20</td> </tr> </tbody> </table>		Analog input range		Digital output voltage (V)	Voltage (V)	Current (mA)	0 to +10	0 to +20	0 to +10	0 to +5	0 to +20	+1 to +5	+4 to +20	-10 to +10	-20 to +20	-5 to +5	-20 to +20	0 to +10	0 to +20	0 to +5	0 to +5	0 to +20	+1 to +5	+4 to +20	+1 to +5	-10 to +10	-20 to +20	-10 to +10	-5 to +5	-20 to +20	-5 to +5	-10 to +10	-20 to +20	-5 to +5	-20 to +20	Section 3.4
	Analog input range		Digital output voltage (V)																																		
	Voltage (V)	Current (mA)																																			
	0 to +10	0 to +20	0 to +10																																		
	0 to +5	0 to +20																																			
	+1 to +5	+4 to +20																																			
	-10 to +10	-20 to +20																																			
	-5 to +5	-20 to +20																																			
	0 to +10	0 to +20	0 to +5																																		
	0 to +5	0 to +20																																			
	+1 to +5	+4 to +20	+1 to +5																																		
	-10 to +10	-20 to +20	-10 to +10																																		
	-5 to +5	-20 to +20	-5 to +5																																		
	-10 to +10	-20 to +20																																			
-5 to +5	-20 to +20																																				
Overall accuracy (%) (Accuracy to full scale)		± 0.3 (Digital output value ± 12)	Section 3.5																																		
Max. absolute input	Voltage (V)	± 15	—																																		
	Current (mA)	± 30																																			
Number of analog input points		16 channels/module	—																																		
Multiplex element		IC relay	—																																		
Isolation		Between input terminals and PLC: Photocoupler isolation Between channels: Non-isolated (1M Ω resistor isolation)	—																																		
Number of I/O points occupied		16 (treated as empty slot) (May be set to 0 by I/O assignment)	—																																		
Terminals connected		38-point terminal block	—																																		
Applicable wire size		0.75 to 2mm ² (18 to 14 AWG) (applicable tightening torque: 39 to 59 N·cm)	—																																		
Applicable solderless terminal		V1.25-3, V1.25-YS3A, V2-S3, V2-YS3A	—																																		
Internal current consumption (A) 5V DC		0.65	—																																		
Weight (kg)		0.55	—																																		

Table 3.3 A60MX Performance List

3. SPECIFICATIONS



3.2.3 A60MXR performance list

Table 3.4 lists the performance capabilities of the A60MXR.

Item		Specifications	Refer To																																	
Analog input	Voltage (V)	-10 to +10 DC (Input resistance: 1MΩ)	—																																	
	Current (mA)	-20 to +20 DC (Input resistance: 250Ω)																																		
Analog output voltage (V)		-10 to +10 DC	—																																	
I/O characteristics	<table border="1"> <thead> <tr> <th colspan="2">Analog input range</th> <th rowspan="2">Digital output voltage (V)</th> </tr> <tr> <th>Voltage (V)</th> <th>Current (mA)</th> </tr> </thead> <tbody> <tr> <td>0 to +10</td> <td>0 to +20</td> <td rowspan="4">0 to +10</td> </tr> <tr> <td>0 to +5</td> <td>0 to +20</td> </tr> <tr> <td>+1 to +5</td> <td>+4 to +20</td> </tr> <tr> <td>-10 to +10</td> <td>-20 to +20</td> </tr> <tr> <td>-5 to +5</td> <td>-20 to +20</td> <td rowspan="4">0 to +5</td> </tr> <tr> <td>0 to +10</td> <td>0 to +20</td> </tr> <tr> <td>0 to +5</td> <td>0 to +20</td> </tr> <tr> <td>+1 to +5</td> <td>+4 to +20</td> </tr> <tr> <td>-10 to +10</td> <td>-20 to +20</td> <td rowspan="2">-10 to +10</td> </tr> <tr> <td>-5 to +5</td> <td>-20 to +20</td> </tr> <tr> <td>-10 to +10</td> <td>-20 to +20</td> <td rowspan="2">-5 to +5</td> </tr> <tr> <td>-5 to +5</td> <td>-20 to +20</td> </tr> </tbody> </table>		Analog input range		Digital output voltage (V)	Voltage (V)	Current (mA)	0 to +10	0 to +20	0 to +10	0 to +5	0 to +20	+1 to +5	+4 to +20	-10 to +10	-20 to +20	-5 to +5	-20 to +20	0 to +5	0 to +10	0 to +20	0 to +5	0 to +20	+1 to +5	+4 to +20	-10 to +10	-20 to +20	-10 to +10	-5 to +5	-20 to +20	-10 to +10	-20 to +20	-5 to +5	-5 to +5	-20 to +20	Section 3.4
	Analog input range		Digital output voltage (V)																																	
	Voltage (V)	Current (mA)																																		
	0 to +10	0 to +20	0 to +10																																	
	0 to +5	0 to +20																																		
	+1 to +5	+4 to +20																																		
	-10 to +10	-20 to +20																																		
	-5 to +5	-20 to +20	0 to +5																																	
	0 to +10	0 to +20																																		
	0 to +5	0 to +20																																		
	+1 to +5	+4 to +20																																		
	-10 to +10	-20 to +20	-10 to +10																																	
	-5 to +5	-20 to +20																																		
	-10 to +10	-20 to +20	-5 to +5																																	
-5 to +5	-20 to +20																																			
Overall accuracy (%) (Accuracy to full scale)		±0.3 (Digital output value ±12)	Section 3.5																																	
Max. absolute input	Voltage (V)	±15	—																																	
	Current (mA)	±30																																		
Number of analog input points		16 channels/module	—																																	
Multiplex element		Mercury-plunger relay	—																																	
Isolation		Between input terminals and PLC: Photocoupler isolation Between channels: Mercury-plunger relay isolation	—																																	
Withstand voltage between channels (V)		500 DC (accuracy guarantee 500 DC)	—																																	
Number of I/O points occupied		16 (treated as empty slot) (May be set to 0 by I/O assignment)	—																																	
Terminals connected		38-point terminal block	—																																	
Applicable wire size		0.75 to 2mm ² (18 to 14 AWG) (applicable tightening torque: 39 to 59 N·cm)	—																																	
Applicable solderless terminal		V1.25-3, V1.25-YS3A, V2-S3, V2-YS3A	—																																	
Internal current consumption (A) 5V DC		0.5	—																																	
Weight (kg)		0.6	—																																	

Table 3.4 A60MXR Performance List

3. SPECIFICATIONS



3.2.4 A60MXRN performance list

Table 3.5 Lists the performance capabilities of the A60MXRN.

Item		Specifications	Refer To																																					
Analog input	Voltage (V)	-10 to +10 DC (Input resistance:1M Ω)	—																																					
	Current (mA)	-20 to +20 DC (Input resistance:250 Ω)																																						
Analog output voltage (V)		-10 to +10 DC	—																																					
I/O characteristics	<table border="1"> <thead> <tr> <th colspan="2">Analog input range</th> <th rowspan="2">Digital output voltage (V)</th> </tr> <tr> <th>Voltage (V)</th> <th>Current (mA)</th> </tr> </thead> <tbody> <tr> <td>0 to +10</td> <td>0 to +20</td> <td rowspan="5">0 to +10</td> </tr> <tr> <td>0 to +5</td> <td>0 to +20</td> </tr> <tr> <td>+1 to +5</td> <td>+4 to +20</td> </tr> <tr> <td>-10 to +10</td> <td>-20 to +20</td> </tr> <tr> <td>-5 to +5</td> <td>-20 to +20</td> </tr> <tr> <td>0 to +10</td> <td>0 to +20</td> <td>0 to +5</td> </tr> <tr> <td>0 to +5</td> <td>0 to +20</td> <td>+1 to +5</td> </tr> <tr> <td>+1 to +5</td> <td>+4 to +20</td> <td>-10 to +10</td> </tr> <tr> <td>-10 to +10</td> <td>-20 to +20</td> <td>-5 to +5</td> </tr> <tr> <td>-5 to +5</td> <td>-20 to +20</td> <td></td> </tr> <tr> <td>-10 to +10</td> <td>-20 to +20</td> <td></td> </tr> <tr> <td>-5 to +5</td> <td>-20 to +20</td> <td></td> </tr> </tbody> </table>		Analog input range		Digital output voltage (V)	Voltage (V)	Current (mA)	0 to +10	0 to +20	0 to +10	0 to +5	0 to +20	+1 to +5	+4 to +20	-10 to +10	-20 to +20	-5 to +5	-20 to +20	0 to +10	0 to +20	0 to +5	0 to +5	0 to +20	+1 to +5	+1 to +5	+4 to +20	-10 to +10	-10 to +10	-20 to +20	-5 to +5	-5 to +5	-20 to +20		-10 to +10	-20 to +20		-5 to +5	-20 to +20		Section 3.4
	Analog input range		Digital output voltage (V)																																					
	Voltage (V)	Current (mA)																																						
	0 to +10	0 to +20	0 to +10																																					
	0 to +5	0 to +20																																						
	+1 to +5	+4 to +20																																						
	-10 to +10	-20 to +20																																						
	-5 to +5	-20 to +20																																						
	0 to +10	0 to +20	0 to +5																																					
	0 to +5	0 to +20	+1 to +5																																					
	+1 to +5	+4 to +20	-10 to +10																																					
	-10 to +10	-20 to +20	-5 to +5																																					
	-5 to +5	-20 to +20																																						
	-10 to +10	-20 to +20																																						
-5 to +5	-20 to +20																																							
Overall accuracy (%) (Accuracy to full scale)		± 0.3 (Digital output value ± 12)	Section 3.5																																					
Max. absolute input	Voltage (V)	± 15	—																																					
	Current (mA)	± 30																																						
Number of analog input points		16 channels/module	—																																					
Multiplex element		Photo Mos relay	—																																					
Isolation		Between input terminals and PLC: Photocoupler isolation Between channels: Photo Mos relay isolation	—																																					
Withstand voltage between channels (V)		400 DC (accuracy guarantee 400 DC)	—																																					
Number of I/O points occupied		16 (treated as empty slot) (May be set to 0 by I/O assignment)	—																																					
Terminals connected		38-point terminal block	—																																					
Applicable wire size		0.75 to 2mm ² (18 to 14 AWG) (applicable tightening torque: 39 to 59 N·cm)	—																																					
Applicable solderless terminal		V1.25-3, V1.25-YS3A, V2-S3, V2-YS3A	—																																					
Internal current consumption (A) 5V DC		0.35	—																																					
Weight (g)		560	—																																					

Table 3.5 A60MXRN Performance List

3.3 A616AD I/O Characteristics

The A616AD allows voltage or current input to be selected per channel by the analog input select SW. Offset/gain setting is performed for 16 channels in block.

Any of the predetermined I/O characteristics is selected in accordance with the settings of the analog input select SW and offset/gain setting switches.

See Section 3.3.1 for the characteristics obtained when the analog input select SW is selected to voltage input and Section 3.3.2 for the characteristics available when that pin is set to current input.

3.3.1 Voltage input characteristics

The following characteristics assume that the analog input select switch has been set to the voltage input.

Analog Input Range (V)	Offset/Gain Setting Pin Position	I/O Characteristic
0 to +10	S1☆ Refer to 8 in Section 4.3.1.	① in Fig. 3.1
0 to +5	S2 Refer to 8 in Section 4.3.1.	② in Fig. 3.1
+1 to +5	S3 Refer to 8 in Section 4.3.1.	③ in Fig. 3.1
-10 to +10	S4 Refer to 8 in Section 4.3.1.	④ in Fig. 3.1
-5 to +5	S5 Refer to 8 in Section 4.3.1.	⑤ in Fig. 3.1

☆ indicates factory setting.

Table 3.6 Analog Input Range, Offset/Gain Setting Pin Position

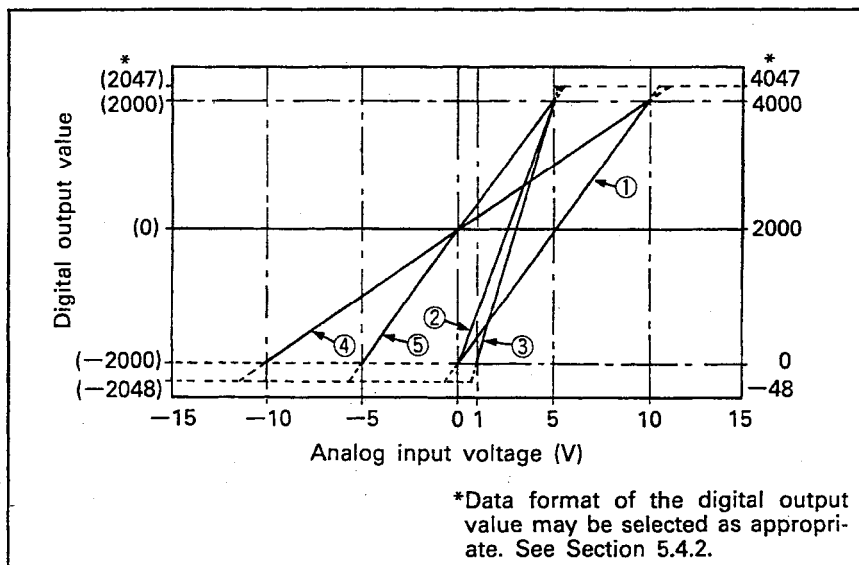

Fig. 3.1 I/O Characteristics

- a) The digital output value has two data formats, -48 to 4047 and -2048 to 2047 . Either format may be selected per channel.
- b) When the input voltage is in the range from -10 to 0 to $+10$ V, the maximum resolution and overall accuracy are within the quoted range of performance specifications. However, if this range is exceeded (dotted line in Fig. 3.1), the resolution and accuracy will be impaired.
- c) If an analog input, corresponding to a digital output value of more than $+4047$ or less than -48 is applied in the data format of -48 to 4047 , the digital output value will not exceed $+4047$ or -48 .
If an analog input, corresponding to a digital output value of more than $+2047$ or less than -2048 is applied in the data format of -2048 to 2047 , the digital output value will not exceed $+2047$ or -2048 .

IMPORTANT

Do not apply ± 15 V or more. This will damage the module.

3.3.2 Current input characteristics

The following characteristics assume that the analog input select switch has been set to the current input.

Analog Input Range (V)	Offset/Gain Setting Pin Position	I/O Characteristic
0 to +20	S1☆ Refer to 8 in Section 4.3.1.	① in Fig. 3.2
0 to +20	S2 Refer to 8 in Section 4.3.1.	② in Fig. 3.2
+4 to +20	S3 Refer to 8 in Section 4.3.1.	③ in Fig. 3.2
-20 to +20	S4 Refer to 8 in Section 4.3.1.	④ in Fig. 3.2
-20 to +20	S5 Refer to 8 in Section 4.3.1.	⑤ in Fig. 3.2

☆ indicates factory setting.

Table 3.7 Analog Input Range, Offset/Gain Setting Pin Position

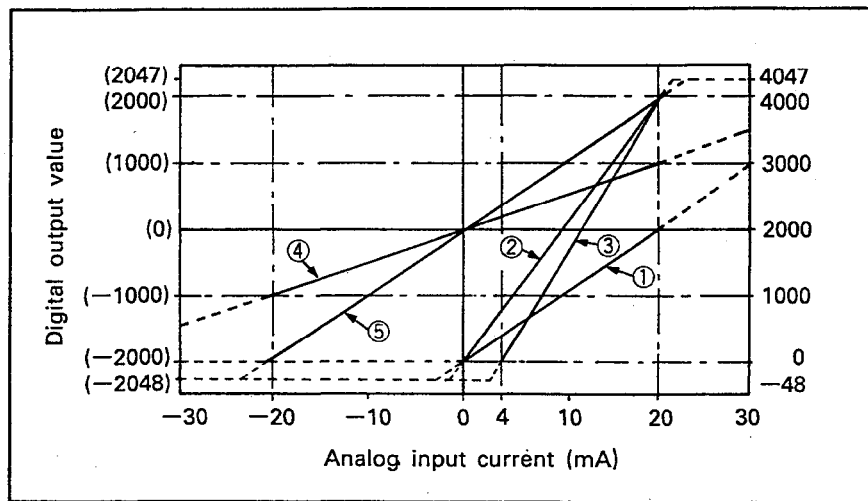

Fig. 3.2 I/O Characteristics

- a) The digital output value has two data formats, -48 to 4047 and -2048 to 2047. Either format may be selected per channel.
- b) When the input current is in the range from -20 to 0 to +20mA, the maximum resolution and overall accuracy are within the quoted range of performance specifications. However, if this range is exceeded (dotted line in Fig. 3.2), the resolution and accuracy will be impaired.
- c) If an analog input, corresponding to a digital output value of more than +4047 or less than -48 is applied in the data format of -48 to 4047, the digital output value will not exceed +4047 or -48.
If an analog input, corresponding to a digital output value of more than +2047 or less than -2048 is applied in the data format of -2048 to 2047, the digital output value will not exceed +2047 or -2048.

IMPORTANT

Do not apply $\pm 30\text{mA}$ or more. This may cause fault due to temperature rise of the internal resistors.

3.4 A60MX/A60MXR/A60MXRN I/O Characteristics

The A60MX and A60MXR allow voltage or current input to be selected per channel by the analog input select switch or analog input select pin, and their offset/gain setting is performed for 16 channels in block.

The A60MXRN allows voltage or current input to be selected per channel by the analog input select pin, and its offset/gain setting is performed for 16 channels in block.

The predetermined I/O characteristics are selected according to the setting positions of the analog input select switch or analog input select pin and the offset/gain setting pins.

The characteristics given in Section 3.4.1 assume that the analog input select switch or analog input select pin is set to voltage input, and those given in Section 3.4.2 assume that the switch or pin is set to current input.

3.4.1 Voltage input characteristics

The following characteristics assume that the analog input select switch or analog input select pin has been set to voltage input.

Analog Input Range (V)	0 to +10		0 to +5		+1 to +5		-10 to +10		-5 to +5	
	Offset/Gain Setting Pin Position	I/O Characteristic	Offset/Gain Setting Pin Position	I/O Characteristic	Offset/Gain Setting Pin Position	I/O Characteristic	Offset/Gain Setting Pin Position	I/O Characteristic	Offset/Gain Setting Pin Position	I/O Characteristic
0 to +10	S 2 1	① in Fig. 3.3	S 2 4	⑥ in Fig. 3.3						
	S 1 1		S 1 1							
0 to +5	S 2 2	② in Fig. 3.3	S 2 1	⑦ in Fig. 3.3						
	S 1 1		S 1 1							
+1 to +5	S 2 3	③ in Fig. 3.3			S 2 1	⑧ in Fig. 3.3				
	S 1 2				S 1 1					
-10 to +10	S 2 4	④ in Fig. 3.3					S 2 1	⑨ in Fig. 3.3	S 2 4	⑪ in Fig. 3.3
	S 1 3						S 1 1		S 1 1	
-5 to +5	S 2 1	⑤ in Fig. 3.3					S 2 2	⑩ in Fig. 3.3	S 2 1	⑫ in Fig. 3.3
	S 1 3						S 1 1		S 1 1	

S1, S2 set to 1 before shipment.

Table 3.8 Analog Input Range, Offset/Gain Setting Pin Position

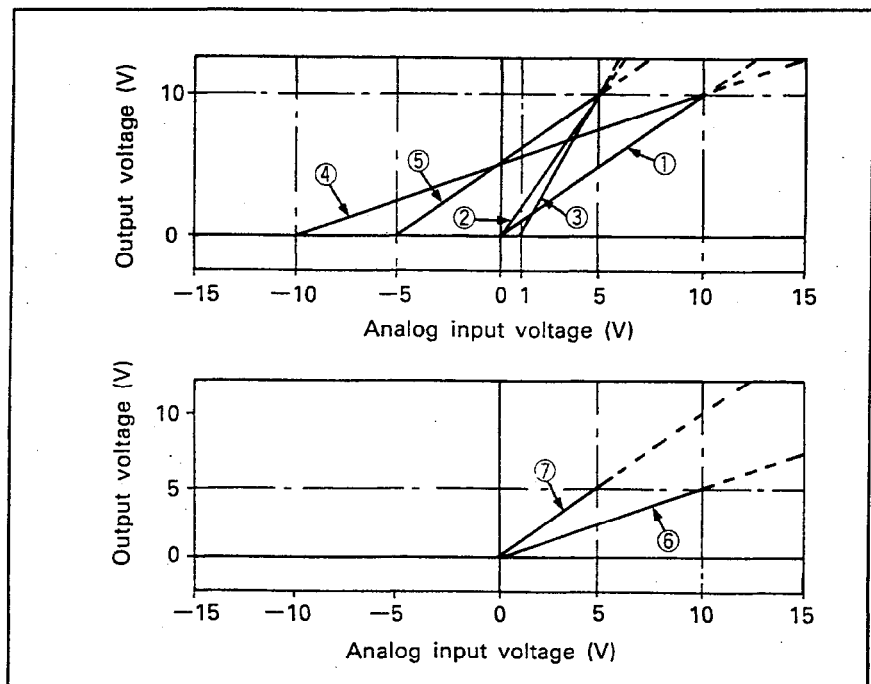

Fig. 3.3 I/O Characteristics (Continue)

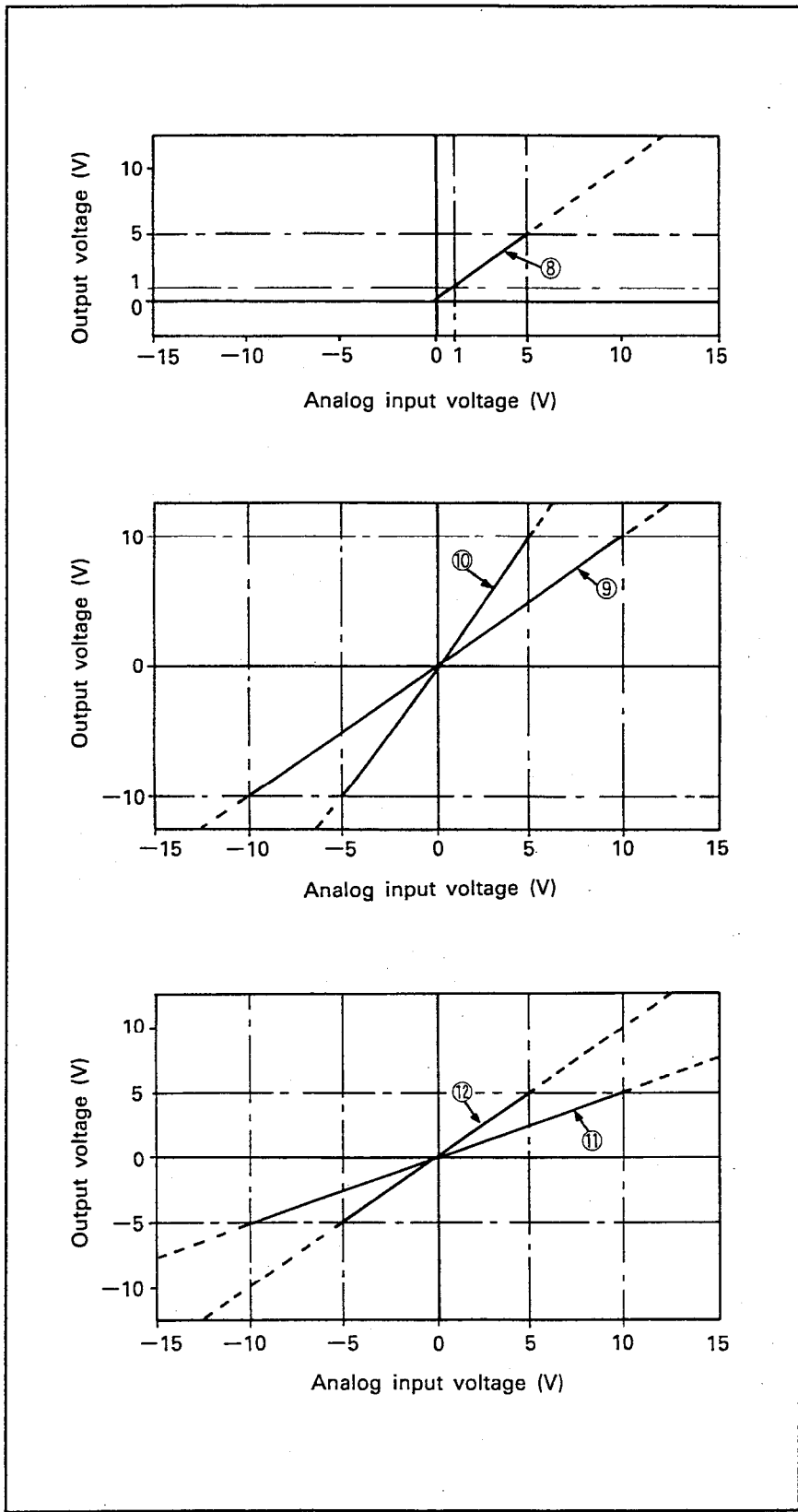

Fig. 3.3 I/O Characteristics

3. SPECIFICATIONS

3.4.2 Current input characteristics

The following characteristics assume that the analog input select switch or analog input select pin has been set to current input.

Analog Output (V) (Input range set to A616AD) Analog Input Range (mA)	0 to +10		0 to +5		+1 to +5		-10 to +10		-5 to +5	
	Offset/Gain Setting Pin Position	I/O Characteristic	Offset/Gain Setting Pin Position	I/O Characteristic	Offset/Gain Setting Pin Position	I/O Characteristic	Offset/Gain Setting Pin Position	I/O Characteristic	Offset/Gain Setting Pin Position	I/O Characteristic
0 to +20	S2 : 1	① in Fig. 3.4	S2 : 4	⑥ in Fig. 3.4						
	S1 : 1		S1 : 1							
0 to +20	S2 : 2	② in Fig. 3.4	S2 : 1	⑦ in Fig. 3.4						
	S1 : 1		S1 : 1							
+4 to +20	S2 : 3	③ in Fig. 3.4			S2 : 1	⑧ in Fig. 3.4				
	S1 : 2				S1 : 1					
-20 to +20	S2 : 4	④ in Fig. 3.4					S2 : 1	⑨ in Fig. 3.4	S2 : 4	⑪ in Fig. 3.4
	S1 : 3						S1 : 1		S1 : 1	
-20 to +20	S2 : 1	⑤ in Fig. 3.4					S2 : 2	⑩ in Fig. 3.4	S2 : 1	⑫ in Fig. 3.4
	S1 : 3						S1 : 1		S1 : 1	

S1, S2 set to 1 before shipment.

Table 3.9 Analog Input Range, Offset/Gain Setting Pin Position

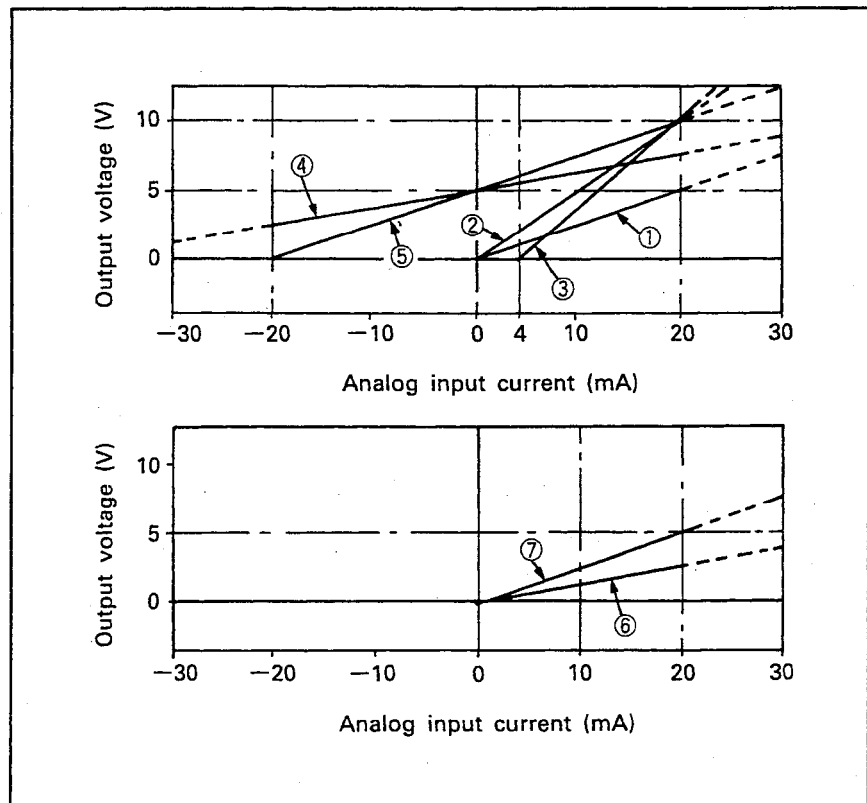

Fig. 3.4 I/O Characteristics (Continue)

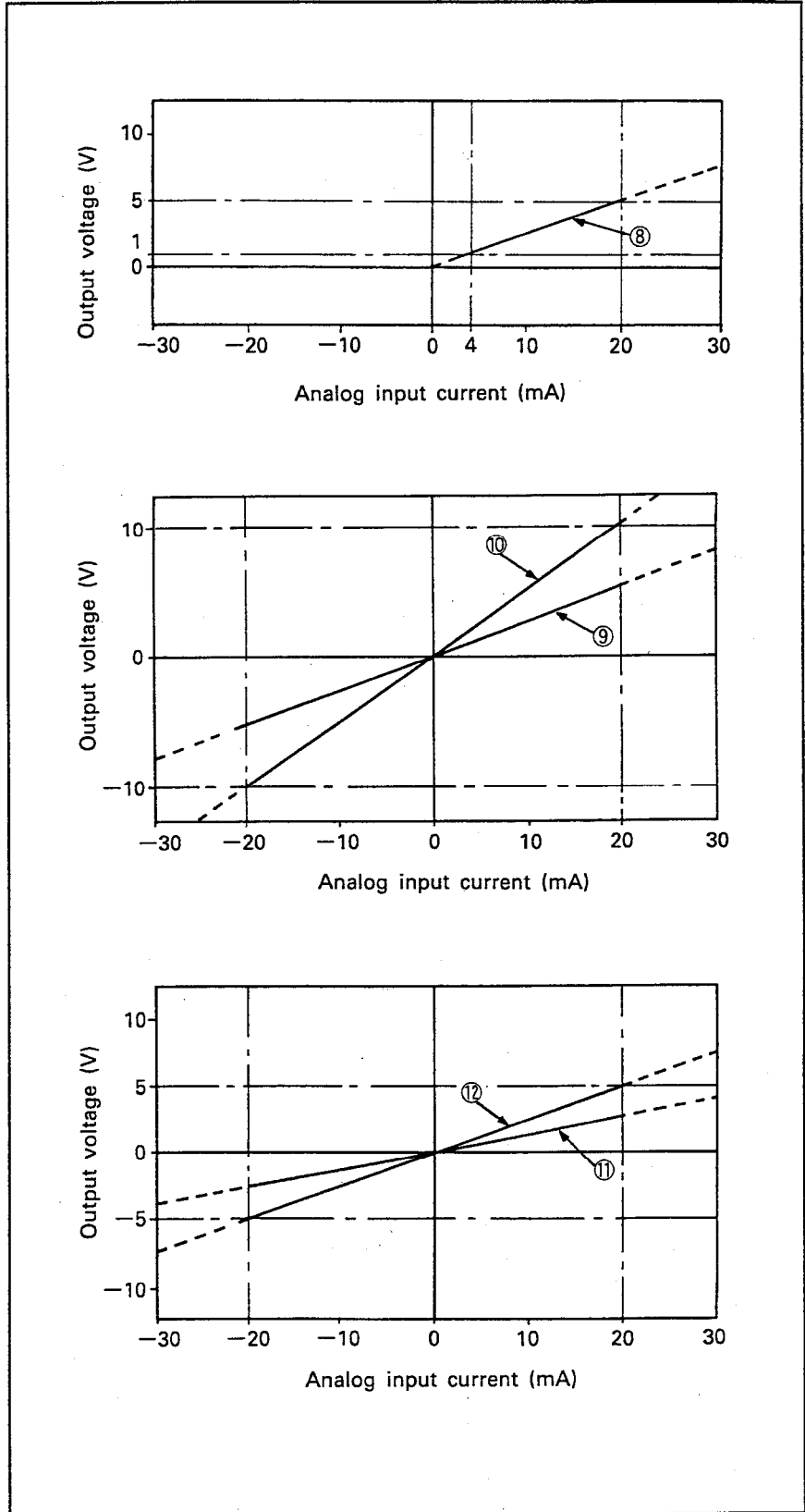

Fig. 3.4 I/O Characteristics

3.5 Overall Accuracy

The graphs given below indicate the overall accuracies (with respect to the maximum value) of the A616AD, A60MX and A60MXR used individually and in combination.

If the I/O characteristic is changed by the offset/gain setting pin, the overall accuracy remains unchanged and is kept within the range of the performance specifications.

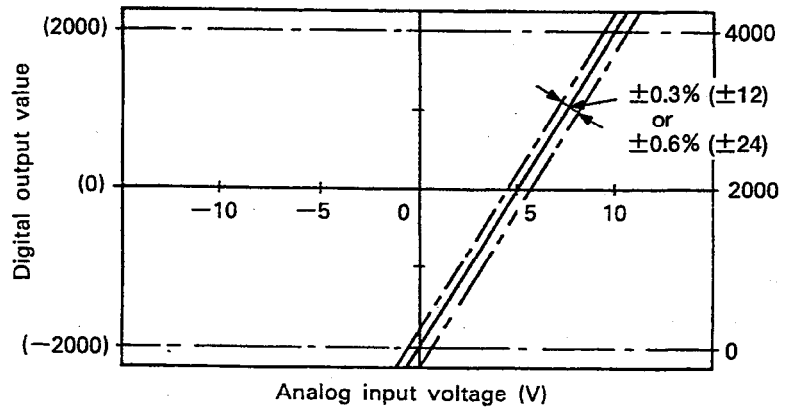

Fig. 3.5 A616AD Overall Accuracy

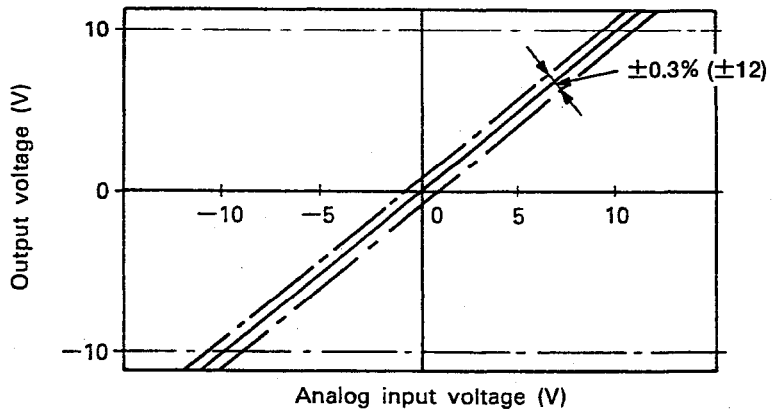

Fig. 3.6 A60MX/A60MXR Overall Accuracy

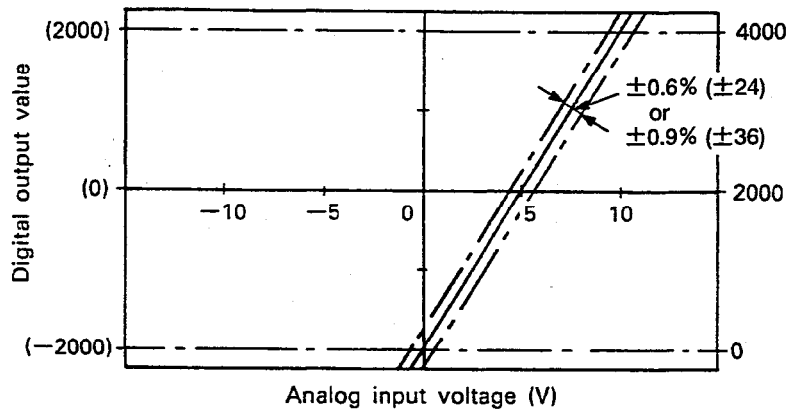
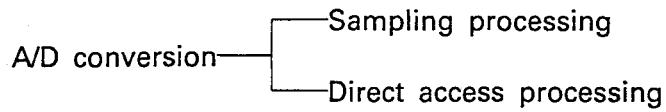

Fig. 3.7 Overall Accuracy when A616AD is Used with A60MX/A60MXR

3.6 A/D Conversion



3.6.1 Sampling processing

Allows A/D conversion to be executed for channels switched from one to another in order of channel number at intervals of 1ms for the A616AD and A60MX, and at time intervals calculated by dividing the preset sampling period by the number of A/D conversion enabled channels for the A60MXR, and the digital output value to be stored to the buffer memory.

3.6.2 Direct access processing

Allows A/D conversion to be directly executed for the sequence program-specified channel by a direct access request. Direct access processing has higher priority than sampling processing.

POINT

<p>Direct access processing is not available if the A616AD is loaded on a remote I/O station.</p>

3.7 Maximum Conversion Speed

Conversion speed indicates the period of time between channel switching and write of the digital value to the buffer memory.

(1) A616AD used alone or used with A60MX

Since the channel switching time is extremely short on the A616AD and A60MX, the maximum conversion speed for sampling processing and direct access processing is equally 1ms.

(2) A616AD used with A60MXR

Since the A60MXR requires several ms as the channel switching time, the processing timing differs between sampling processing and direct access processing and the maximum conversion speed also differs between them.

(a) Sampling processing

As sampling processing is executed in the predetermined order of A60MXR channels, the processing of the A616AD channel can be performed during execution of the ON/OFF processing of the A60MXR.

After the sampling period set to the A60MXR channel has elapsed, the A616AD performs the A/D conversion of the specified A60MXR channel or write to buffer memory.

Since the ON/OFF processing time can be ignored by the A616AD, the maximum conversion speed is 1ms.

(b) Direct access processing

As direct access processing is executed for randomly specified A60MXR channels, the ON/OFF processing of the specified channel is performed after the direct access request is input.

Since sampling processing cannot be resumed until completion of direct access processing, the ON/OFF processing time for the A616AD is also added to the maximum conversion speed, and the maximum conversion speed is therefore 7ms.

- (3) Influence of FROM / TO instruction execution on maximum conversion speed

The maximum conversion speed indicated in (1) and (2) assumes that the FROM / TO instruction is not executed. If the FROM / TO instruction is executed:

- a) Digital value write to the buffer memory is held during FROM / TO processing until FROM / TO processing is complete.
- b) Channel switching is held during FROM / TO processing until FROM / TO processing is complete.
- c) FROM / TO processing is held during digital value write to the buffer memory or channel switching until the write or channel switching processing is complete.
- d) The FROM / TO instructions should be specified to transfer several data at one time. Processing is less influenced if the number of FROM / TO instructions is smaller.

3.8 Processing Timing

(1) A616AD used alone

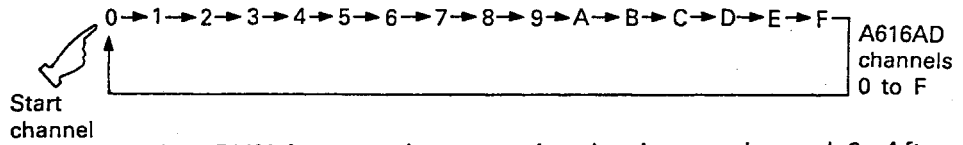

After RUN is started, processing begins at channel 0. After processing is performed at channels 0 through F, it returns to channel 0.

(2) A616AD used with A60MX

The following example assumes that the A60MXs are connected to channels 0 and 1 of the A616AD.

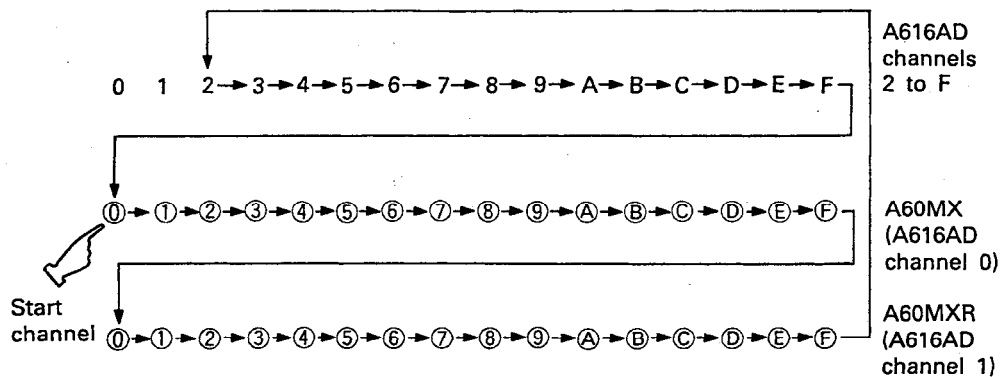

After RUN is started, processing begins at channel 0 of the A60MX which is connected to the A616AD channel 0.

(3) A616AD used with A60MXR

1) The following example assumes that the A60MXR is connected to channel 0 of the A616AD.

In this case, the set sampling period of the A60MXR is 112ms and the number of A/D conversion enable channels is 16 (sampling interval: $112 \div 16 = 7\text{ms}$).

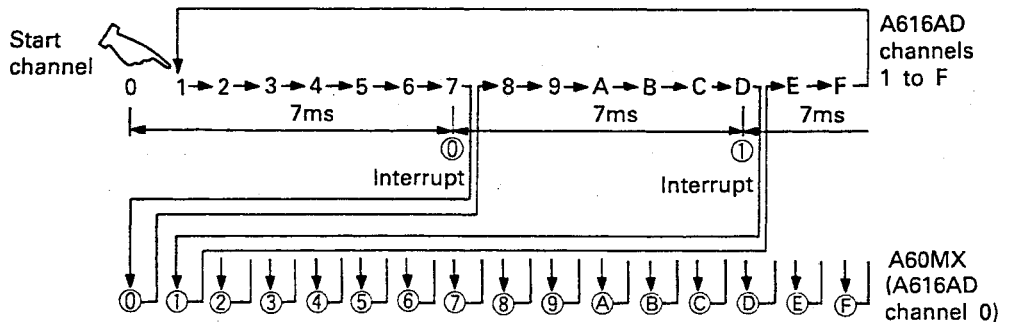

After RUN is started, processing begins at channel 1 of the A616AD.

- 2) The following example assumes that seven A60MXRs are connected to the A616AD channels 0 to 6, the A616AD channels 7 to 15 disabled for conversion, and all A60MXR channels enabled for conversion.

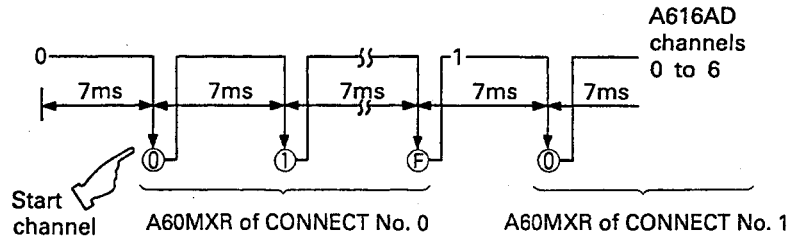

After RUN is started, processing begins at channel 0 of the A60MXR which is connected to the A616AD channel 0.

3.9 Function Block Diagrams

3.9.1 A616AD function block diagram

The following is the function block diagram of the A616AD.

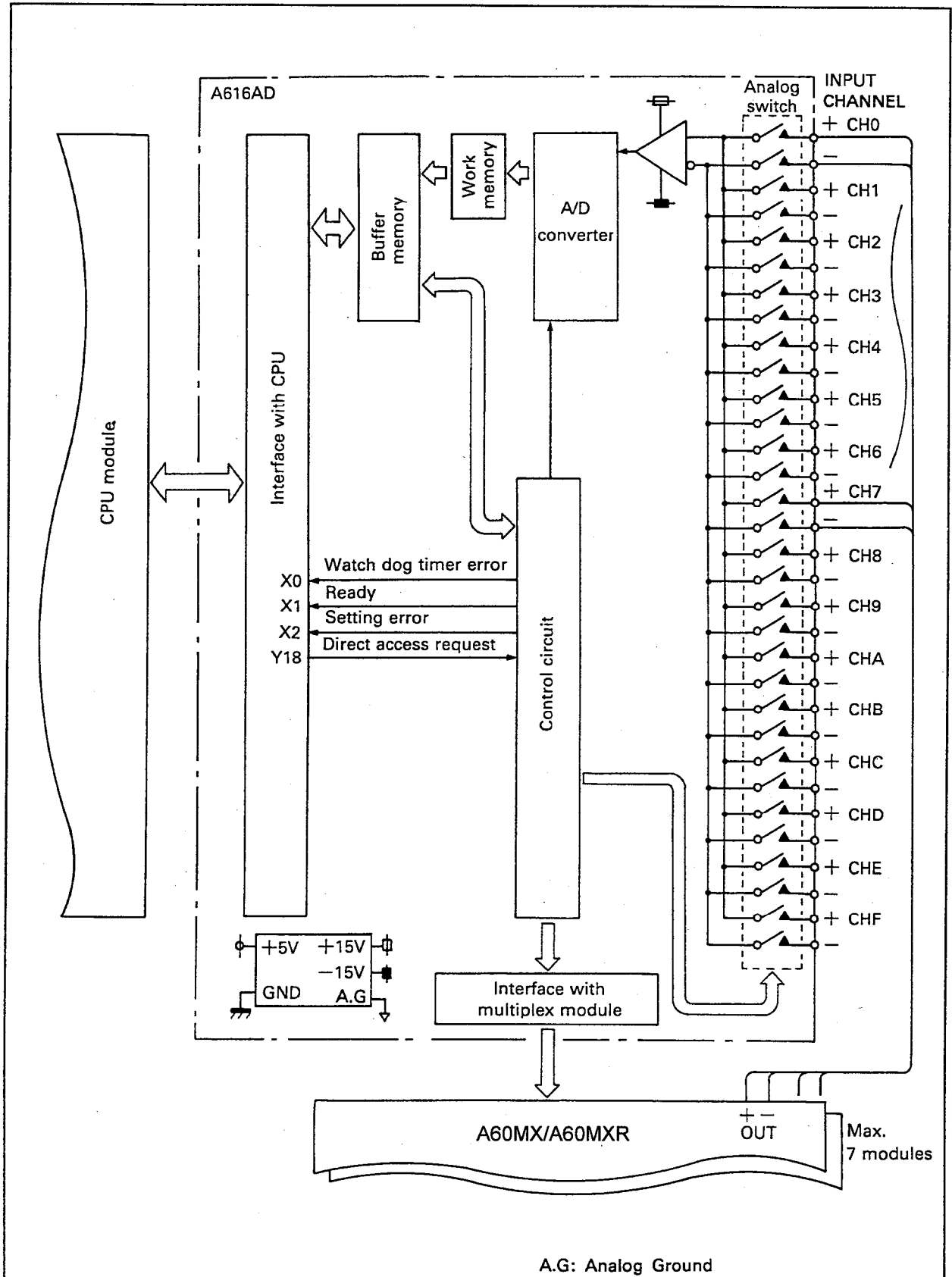

A.G: Analog Ground

3.9.2 A60MX function block diagram

The following is the function block diagram of the A60MX.

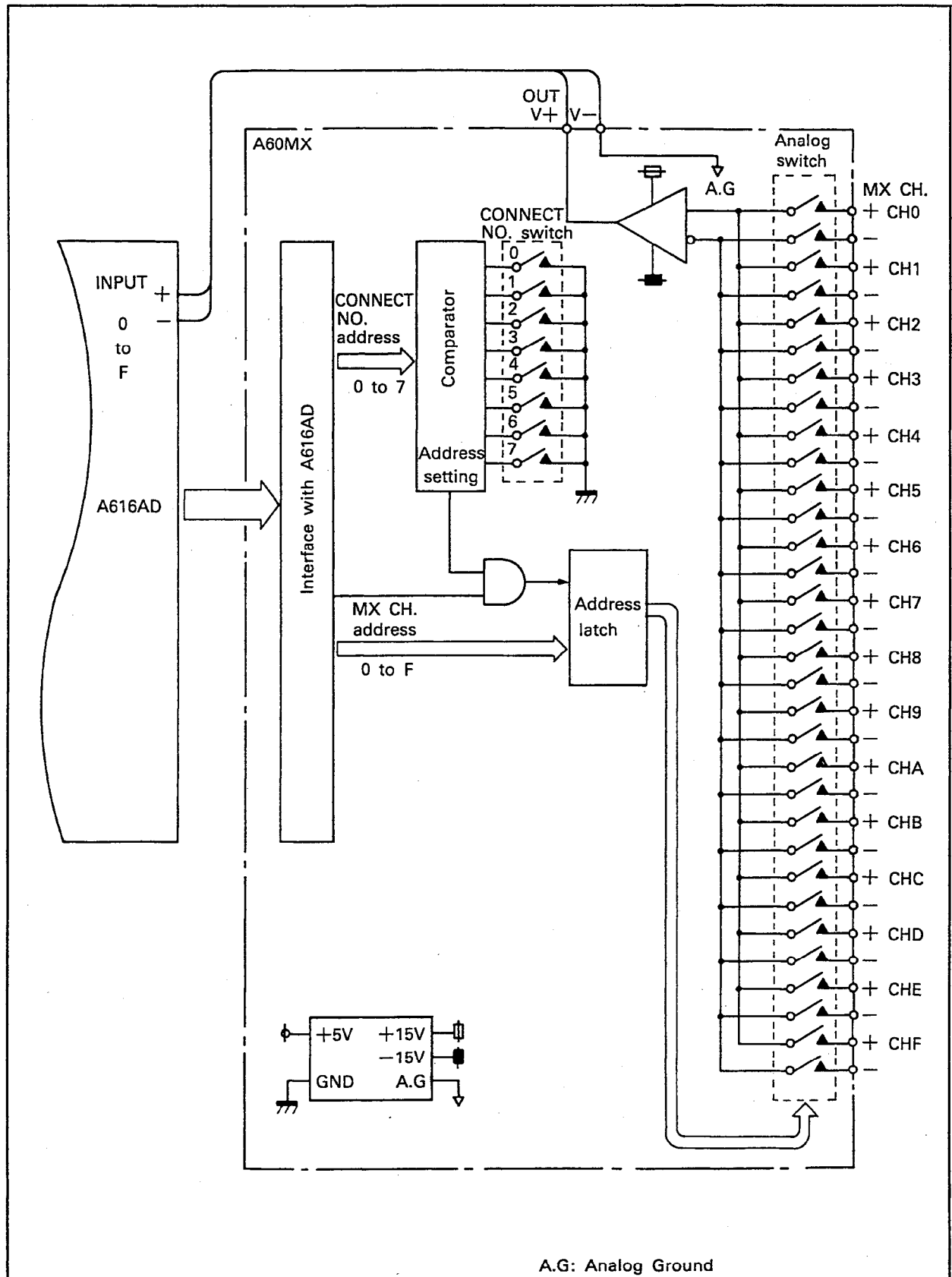

3.9.3 A60MXR function block diagram

The following is the function block diagram of the A60MXR.

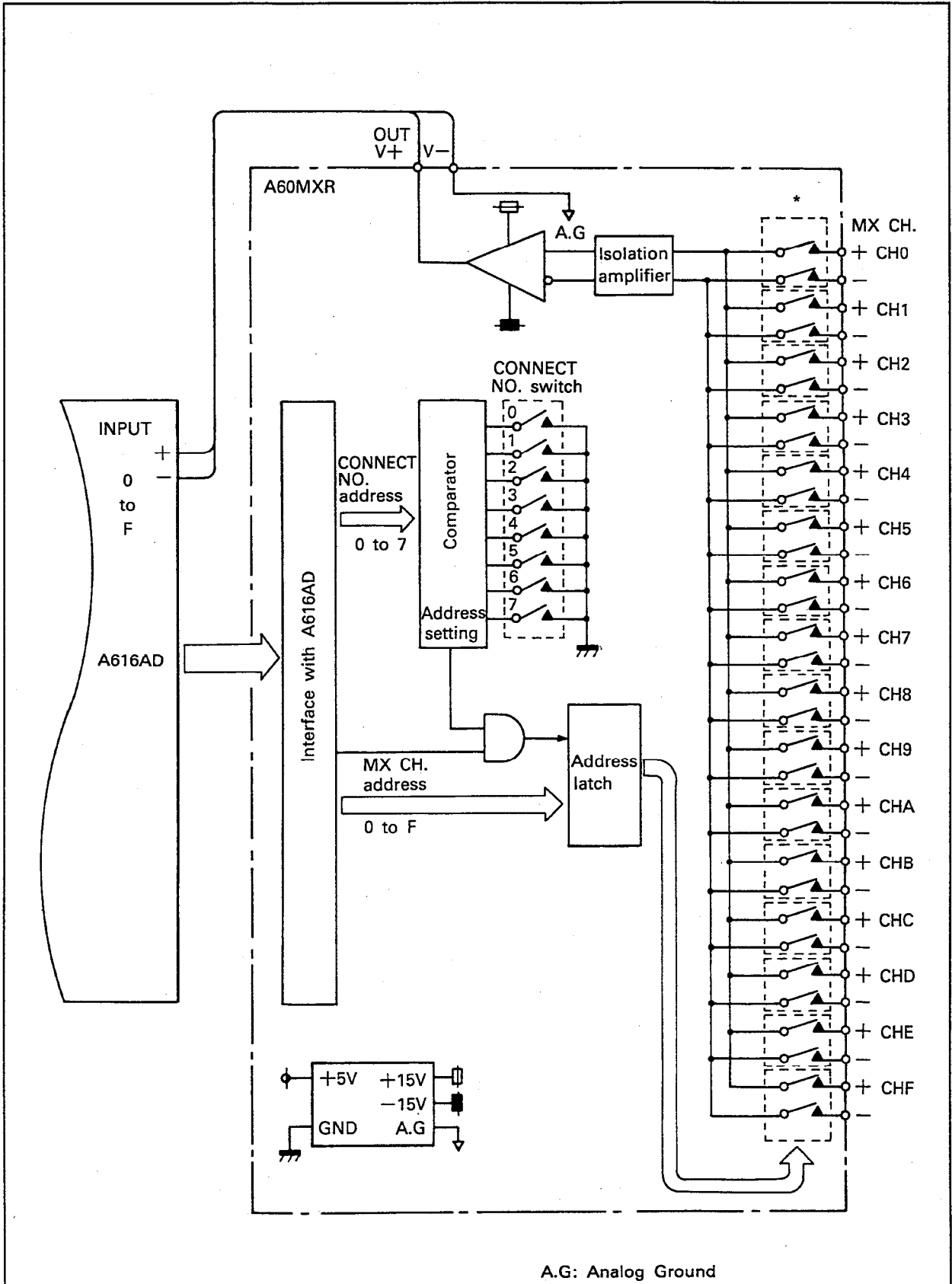

A.G: Analog Ground

* The A60MXR uses mercury-plunger relays and the A60MXRN uses photo MOS relays.

3.10 Useful Life of the A60MXR Mercury-Plunger Relay

The mercury-plunger life of the A60MXR is 900 million times. The useful life of the mercury-plunger relay is directly proportional to the sampling period.

Fig. 3.8 shows the relation between the sampling period and mercury-plunger relay useful life.

In order to increase the useful life of the mercury-plunger relay, maximize the sampling period by enabling unused channels for conversion.

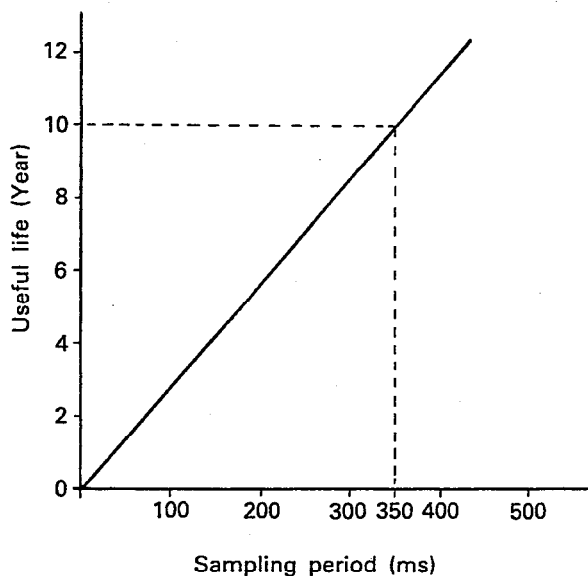

Mercury-plunger life 900 million times
 Operation time 8760 hours
 (24 hours × 365 days)
 Sampling period 350ms
 Useful life = sampling period
 × $\frac{\text{mercury-plunger relay life}}{\text{operation time (ms)}}$

$$t = 350 \times \frac{9 \times 10^8}{8760 \times 60 \times 60 \times 10^3}$$

$$= 10 \text{ (years)}$$

Fig. 3.8 Useful Life of Mercury-Plunger Relay

4. PRE-OPERATION SETTINGS AND PROCEDURES

4.1 Pre-Operation Settings and Procedures

The following flowchart gives the pre-operation setting procedure for the A616AD, A60MX and A60MXR after unpacking.

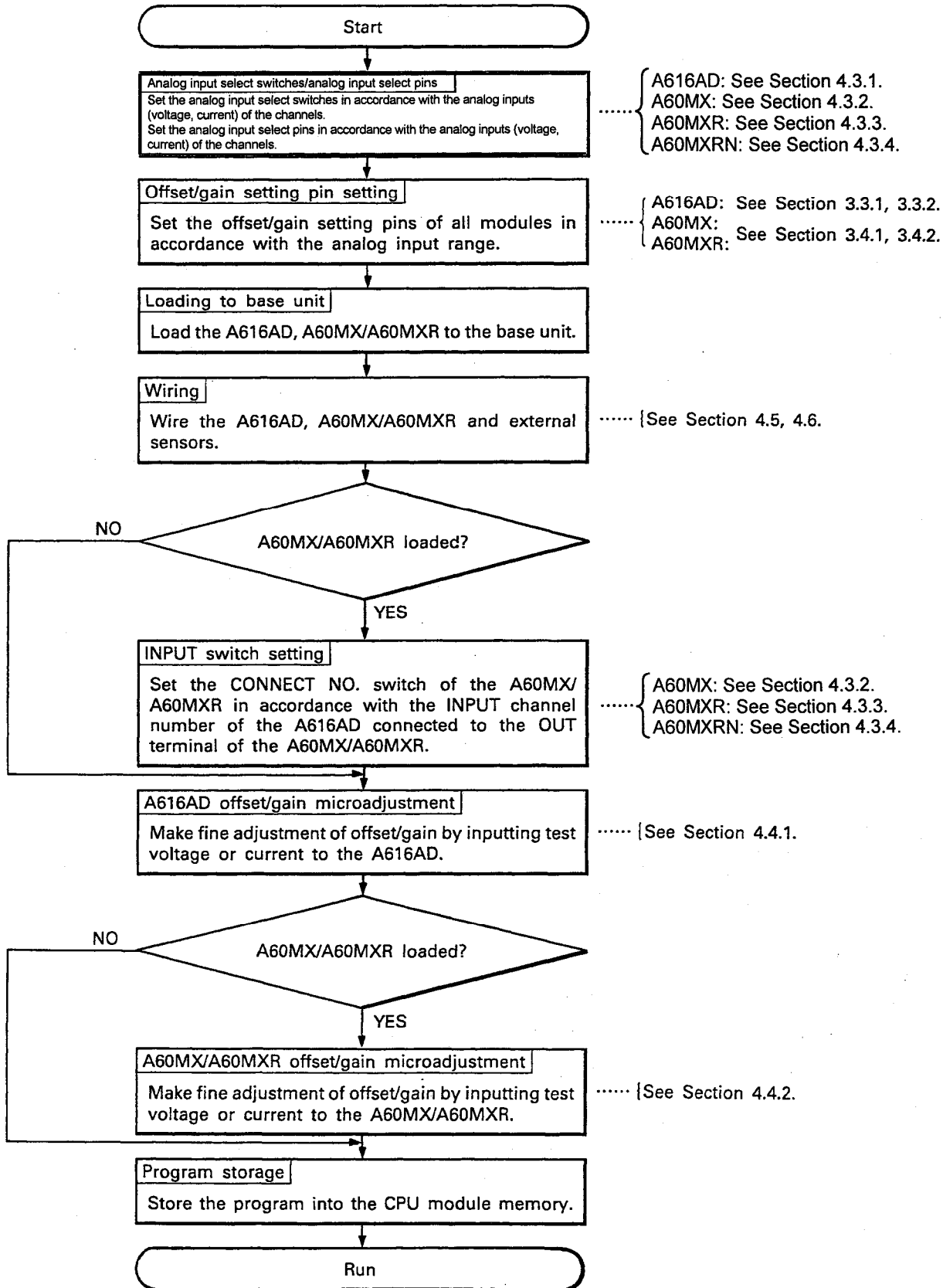

4.2 Handling Instructions

This section provides the handling instructions of the A616AD, A60MX and A60MXR.

- (1) Protect the A616AD, A60MX/A60MXR and their terminal blocks from impact loads.
- (2) Do not remove printed circuit boards from the housing. There are no user-serviceable parts on the boards.
- (3) Ensure that no conductive debris can enter the module. If it does, make sure that it is removed. Guard particularly against wire offcuts.
- (4) Tighten terminal screws as specified below:

Screw	Tightening Torque Range
I/O terminal block terminal screws (M3)	39 to 59 N·cm
I/O terminal block installation screws (M4)	78 to 118 N·cm

- (5) To load the module onto the base, press the module against the base so that the hook is securely locked. To unload the module, push the catch on top of the module, and after the hook is disengaged from the base, pull the module toward you.
- (6) Remove the side panel from the left-hand side of the module as shown on the left below. Install the side panel as shown on the right below.

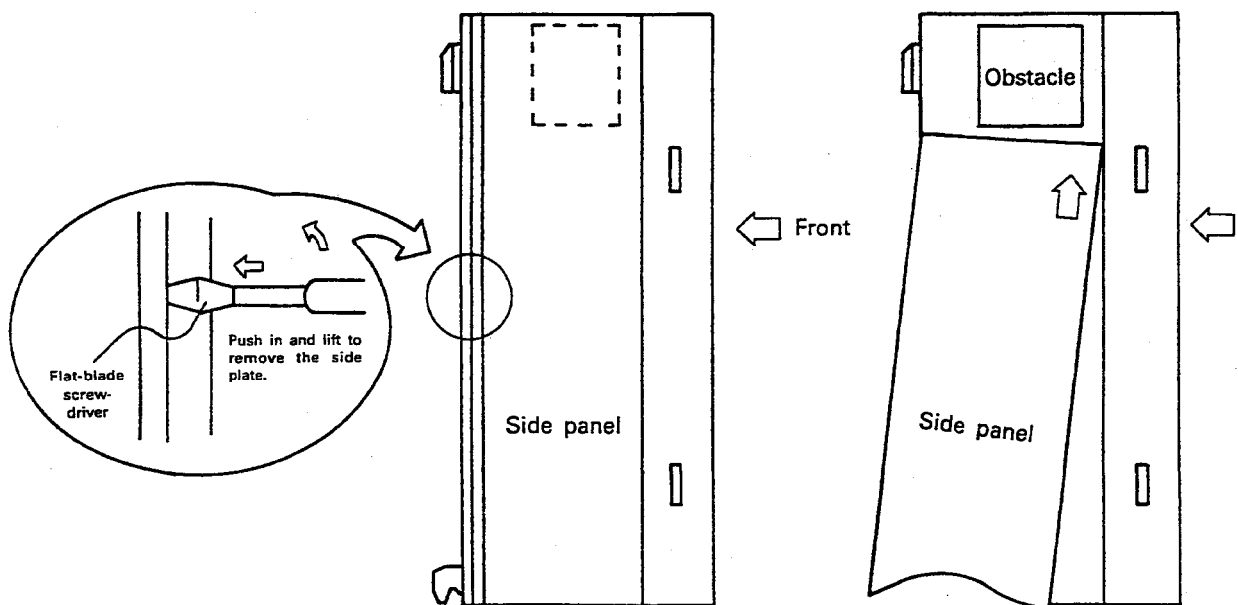







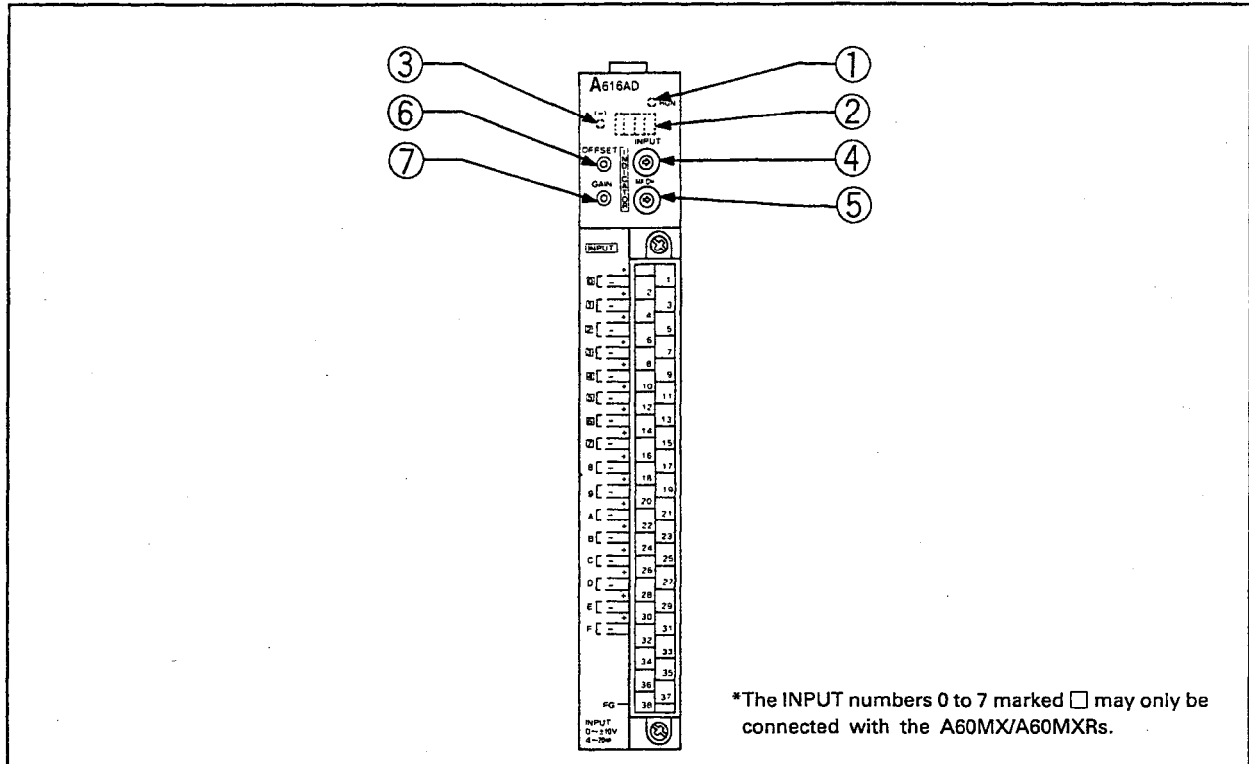

4.3 Nomenclature

4.3.1 A616AD

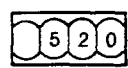
This section explains the part names and settings of the A616AD.



No.	Name and Appearance	Description
①	<p>RUN LED</p> 	<p>Indicates the operating status of the A616AD.</p> <p>On: Indicates that the A616AD is operating without fault.</p> <p>Flicker: Indicates that disable area write error, sampling period setting error, etc. has occurred. See Section 6.1.</p> <p>Off: Indicates 5V power-off, watch dog timer error or A60MX/A60MXR module fault.</p>
②	<p>LED Display</p> 	<p>(1) Digital value indication</p> <ul style="list-style-type: none"> Indicates a digital value of the channel specified by the INPUT switch and MX CH. switch. Updates a digital value in 0.5s increments. Indicates a digital value as a 4-digit decimal (in the range -48 to 4047 or -2048 to +2047). The minus indicator LED (③) is lit to indicate a negative digital value. <p>(2) Error number indication</p> <ul style="list-style-type: none"> If an error has occurred, the corresponding error code is displayed as shown below:  <p style="text-align: center;">Error code is indicated by the two least significant digits.</p>
③	<p>Minus indicator LED</p> 	<p>Lit to indicate that the digital value is negative.</p> <p>Example: Value -520.</p>  

No.	Name and Appearance	Description
④	<p data-bbox="253 309 411 331">INPUT switch</p> <div style="text-align: center;"> <p data-bbox="427 450 491 472">INPUT</p>  </div>	<p data-bbox="681 309 1422 360">Used to specify the channel of which digital value is displayed on the LED display.</p> <p data-bbox="681 360 948 383">(1) A616AD used alone</p> <ul style="list-style-type: none"> <li data-bbox="716 387 1422 439">• The LED display (②) indicates the digital value of the specified channel. <li data-bbox="716 443 979 465">• Setting range: 0 to F <p data-bbox="681 495 1123 517">(2) A616AD used with A60MX/A60MXR</p> <ul style="list-style-type: none"> <li data-bbox="716 521 1422 573">• Used to select the A60MX/A60MXR module connected to the channel specified by the INPUT switch. <li data-bbox="716 577 1422 629">• Use the MX CH. switch (⑤) to specify the channel of the module selected. <li data-bbox="716 633 979 656">• Setting range: 0 to 7
⑤	<p data-bbox="253 678 427 701">MX CH. switch</p> <div style="text-align: center;"> <p data-bbox="427 775 496 797">MX CH.</p>  </div>	<p data-bbox="681 678 1422 730">Used to specify the channel of which digital value is displayed on the LED display. (Valid when A60MX/A60MXR is used)</p> <p data-bbox="681 759 948 781">(1) A616AD used alone</p> <p data-bbox="716 786 900 808">No need to set.</p> <p data-bbox="681 813 1123 835">(2) A616AD used with A60MX/A60MXR</p> <ul style="list-style-type: none"> <li data-bbox="716 840 1422 913">• The LED display (②) indicates the digital value of the MX CH. switch-specified channel of the module selected by the INPUT switch. <li data-bbox="716 918 979 940">• Setting range: 0 to F
⑥	<p data-bbox="253 958 427 981">OFFSET control</p> <div style="text-align: center;"> <p data-bbox="427 1055 496 1077">OFFSET</p>  </div>	<p data-bbox="681 958 1422 1032">Used to make microadjustment of an offset value, which is selected by the setting pins S1 and S5 in the module. For further details, see Section 4.4.</p>
⑦	<p data-bbox="253 1216 411 1238">GAIN control</p> <div style="text-align: center;"> <p data-bbox="440 1323 483 1346">GAIN</p>  </div>	<p data-bbox="681 1216 1422 1290">Used to make microadjustment of a gain value, which is selected by the setting pins S1 and S5 in the module. For further details, see Section 4.4.</p>

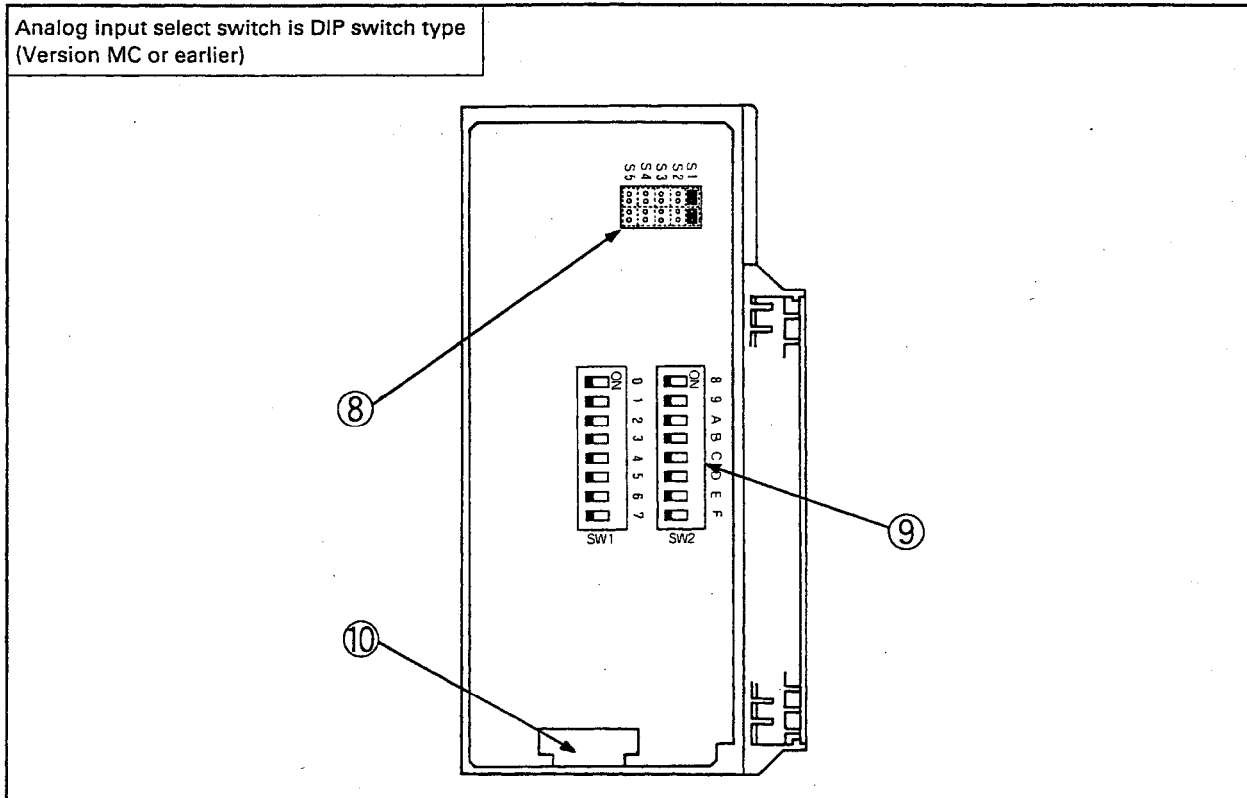

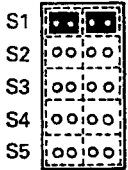
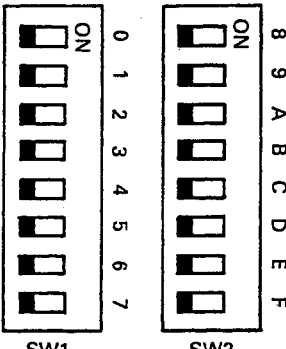
No.	Name and Appearance	Description
⑧	<p>Offset/gain setting pins</p> 	<p>Set the S1 and S5 setting pins in accordance with the analog input voltage/current range. For more information, see Section 3.3. Factory-set to S1. When the setting has been changed to other than "S1", make the offset/gain adjustment.</p>
⑨	<p>Analog input select SWs</p> 	<p>Used to select the analog input (voltage or current input) of each channel (CH0 to F). Corresponding channels of SW1, SW2 Set to OFF to define voltage input. Set to ON to define current input. Set to "OFF" before shipment. When the setting has been changed to "ON", make the offset/gain adjustment.</p> <div style="border: 1px solid black; padding: 5px; margin-top: 10px;"> <p>IMPORTANT</p> <p>Any channel connected with the A60MX or A60MXR must be set to V.</p> </div>
⑩	<p>Extension cable connector</p>	<p>For connecting the extension cable when increasing the channel(s) by the A60MX/A60MXR.</p>

Analog input select switch is jumper type
(Version NC or later)

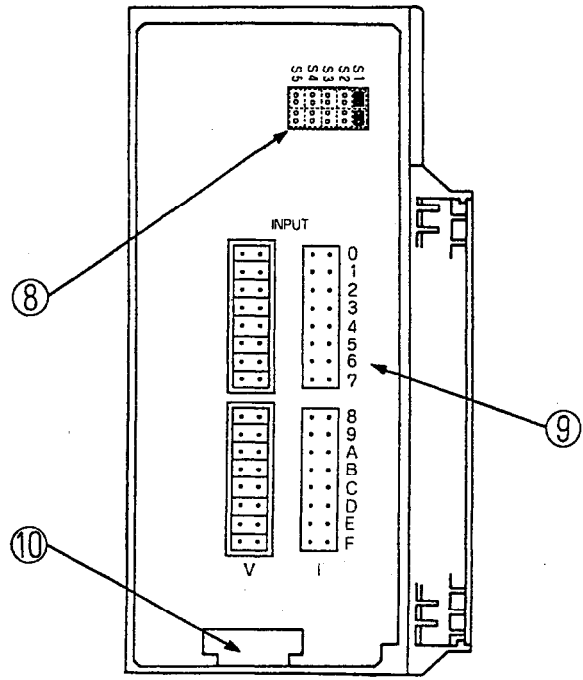

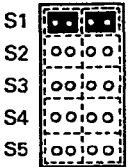
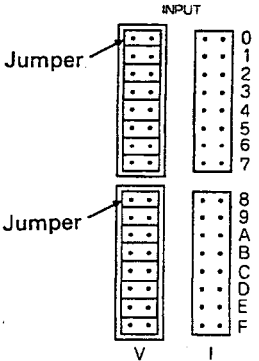

No.	Name and Appearance	Description
⑧	<p>Offset/gain setting pins</p> 	<p>Set the S1 and S5 setting pins in accordance with the analog input voltage/current range.</p> <p>Factory-set to S1.</p> <p>When the setting has been changed to other than "S1", make the offset/gain adjustment.</p>
⑨	<p>Analog input select setting pin</p> 	<p>Used to select the analog input (voltage or current input) of each channel (CH0 to F).</p> <p>Voltage input setting: "V" position Current input setting: "I" position</p> <p>Set to "V" before shipment.</p> <p>When the setting has been changed to "I", make the offset/gain adjustment.</p> <div style="border: 1px solid black; padding: 5px; margin-top: 10px;"> <p>IMPORTANT</p> <p>Any channel connected with the A60MX or A60MXR must be set to V.</p> </div>
⑩	<p>Extension cable connector</p>	<p>For connecting the extension cable when increasing the channel(s) by the A60MX/A60MXR.</p>

4.3.2 A60MX

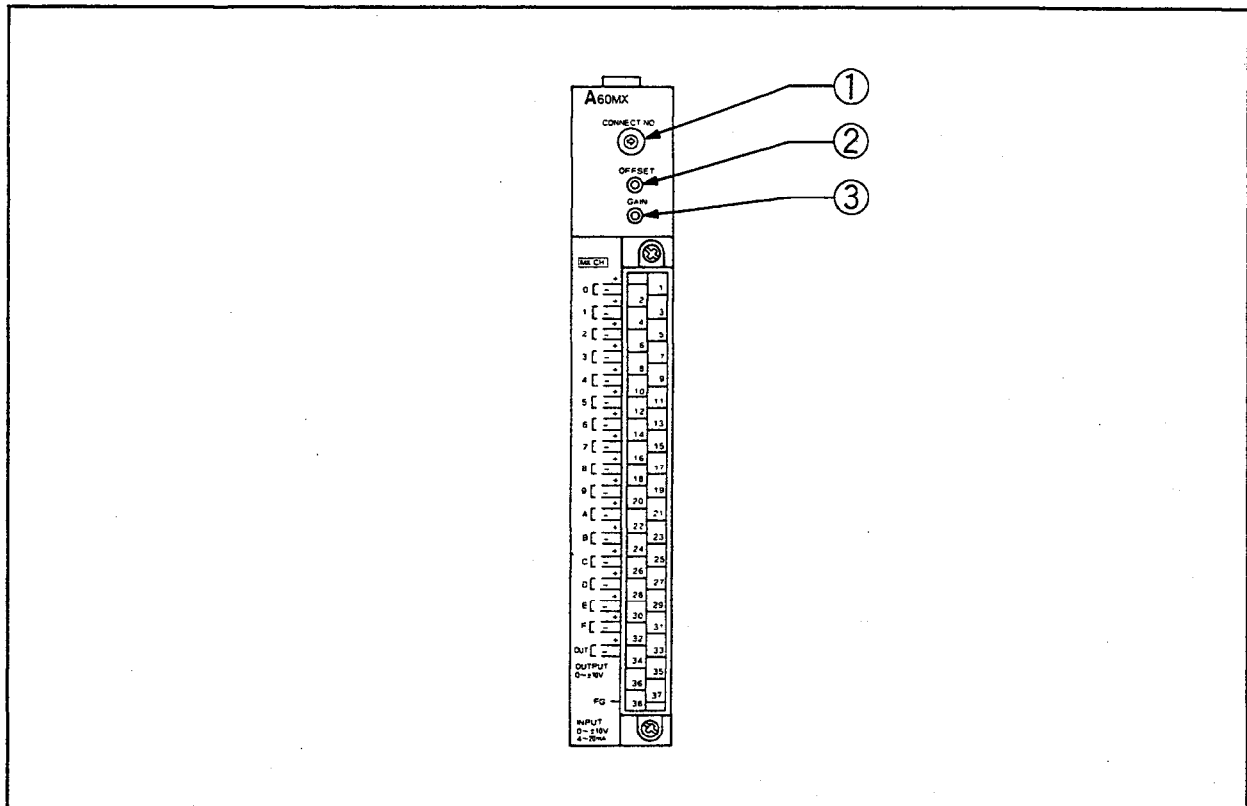
This section explains the part names and settings of the A60MX.



No.	Name and Appearance	Description
①	<p>CONNECT NO. switch</p> <p style="text-align: center;">CONNECT NO.</p> 	<p>Used to define the INPUT terminal of the A616AD connected with the OUT terminal of the A60MX.</p> <p>Setting range: 0 to 7</p>
②	<p>OFFSET control</p> <p style="text-align: center;">OFFSET</p> 	<p>Used to make microadjustment of an offset value, which is selected by the setting pins S1 and S2 in the module. For further details, see Section 4.4.</p>
③	<p>GAIN control</p> <p style="text-align: center;">GAIN</p> 	<p>Used to make microadjustment of a gain value, which is selected by the setting pins S1 and S2 in the module. For further details, see Section 4.4.</p>

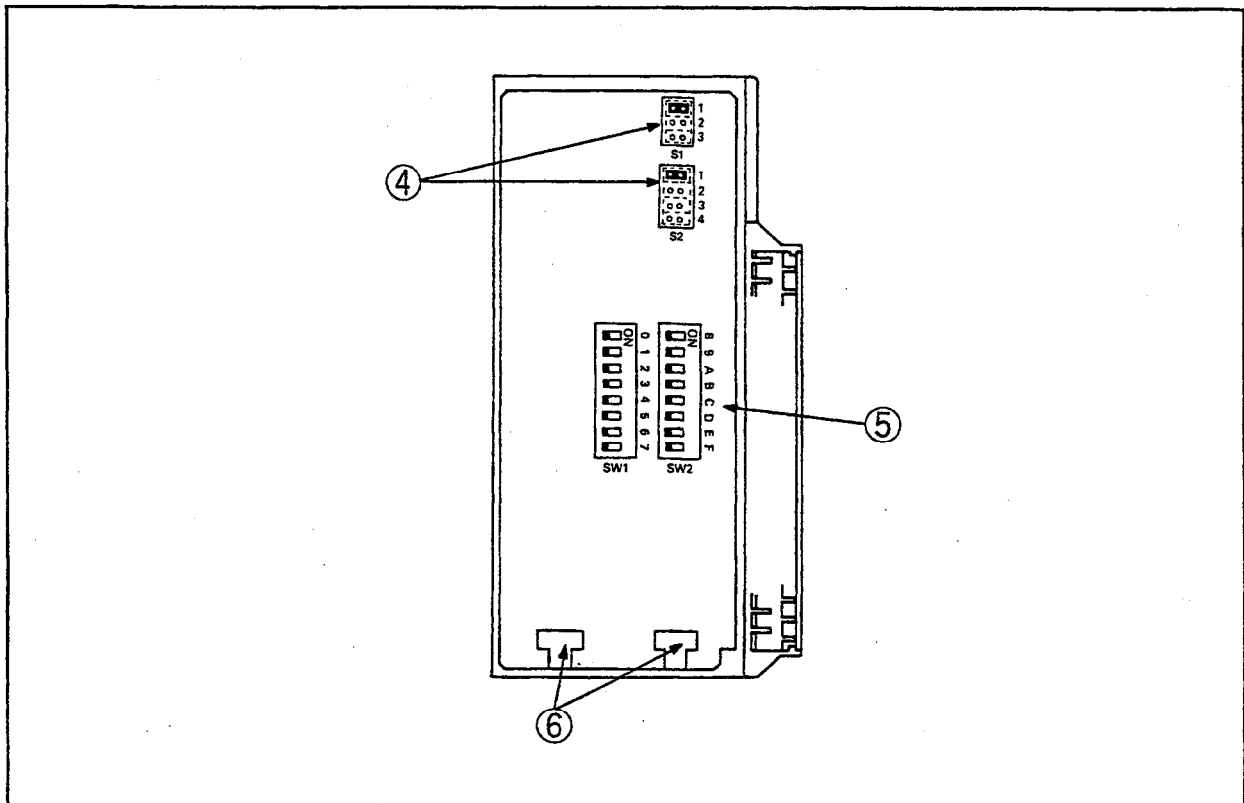

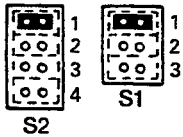
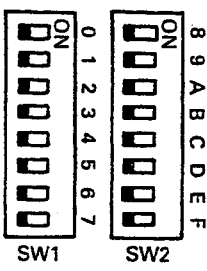

No.	Name and Appearance	Description
④	<p>Offset/gain setting pins</p> 	<p>Set the S1 and S2 setting pins in accordance with the analog input voltage/current range and A616AD offset/gain setting pin positions. For more information, see Section 3.4.</p>
⑤	<p>Analog input select SWs</p> 	<p>Used to select the analog input (voltage or current input) of each channel (CH0 to F).</p> <p>Corresponding channels of SW1, SW2</p> <p>Set to OFF to define voltage input. Set to ON to define current input.</p> <p>Set to "OFF" before shipment.</p>
⑥	<p>Extension cable connector</p>	<p>For connecting the extension cable of the adjacent module when increasing a channel by loading the other A60MX / A60MXR / A60MXRN next to the A60MXR. The extension cable may be connected to either of the two connectors.</p>

4.3.3 A60MXR

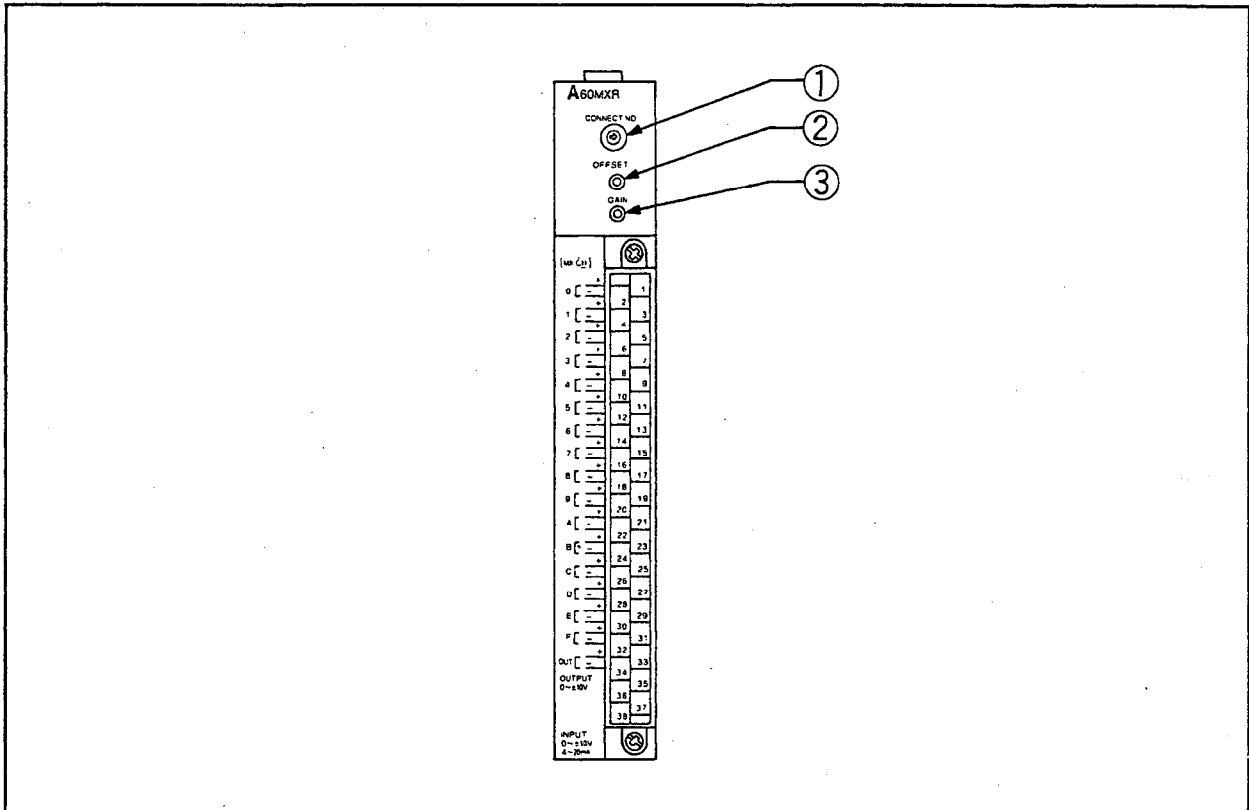
This section explains the part names and settings of the A60MXR.



No.	Name and Appearance	Description
①	<p>CONNECT NO. switch</p> <p style="text-align: center;">CONNECT NO.</p> 	<p>Used to define the INPUT terminal of the A616AD connected with the OUT terminal of the A60MXR.</p> <p>Setting range: 0 to 7</p>
②	<p>OFFSET control</p> <p style="text-align: center;">OFFSET</p> 	<p>Used to make microadjustment of an offset value, which is selected by the setting pins S1 and S2 in the module. For further details, see Section 4.4.</p>
③	<p>GAIN control</p> <p style="text-align: center;">GAIN</p> 	<p>Used to make microadjustment of a gain value, which is selected by the setting pins S1 and S2 in the module. For further details, see Section 4.4.</p>

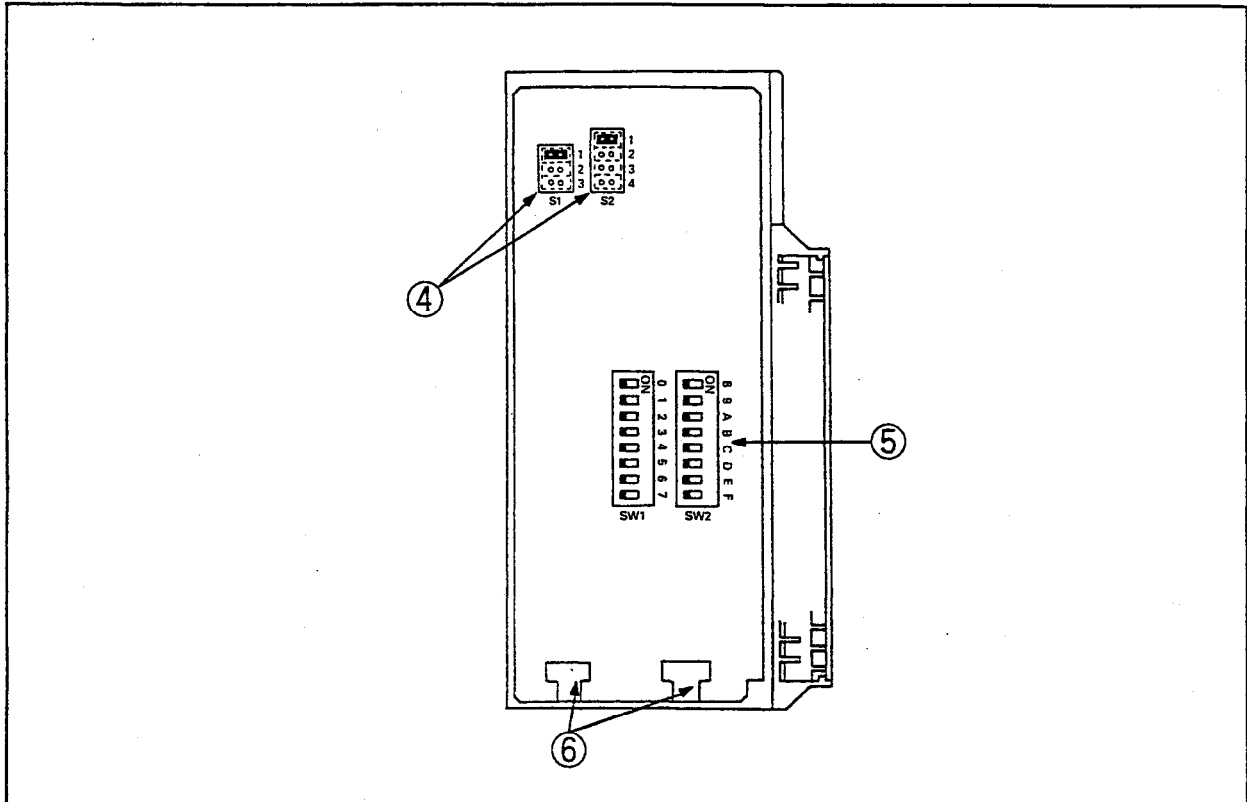

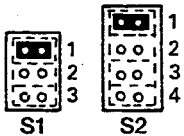
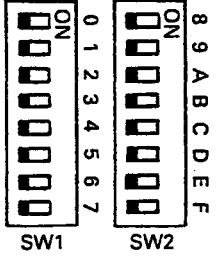

No.	Name and Appearance	Description
④	<p data-bbox="260 1081 523 1115">Offset/gain setting pins</p> 	<p data-bbox="686 1081 1423 1171">Set the S1 and S2 setting pins in accordance with the analog input voltage/current range and A616AD offset/gain setting pin positions. For more information, see Section 3.4.</p>
⑤	<p data-bbox="260 1317 547 1350">Analog input select SWs</p> 	<p data-bbox="686 1317 1423 1373">Used to select the analog input (voltage or current input) of each channel (CH0 to F).</p> <p data-bbox="686 1395 1114 1429">Corresponding channels of SW1, SW2</p> <p data-bbox="710 1451 1106 1507">Set to OFF to define voltage input. Set to ON to define current input.</p> <p data-bbox="686 1529 1034 1563">Set to "OFF" before shipment.</p>
⑥	<p data-bbox="260 1680 563 1713">Extension cable connector</p>	<p data-bbox="686 1680 1423 1814">For connecting the extension cable of the adjacent module when increasing a channel by loading the other A60MX / A60MXR / A60MXRN next to the A60MXR. The extension cable may be connected to either of the two connectors.</p>

4.3.4 A60MXRN

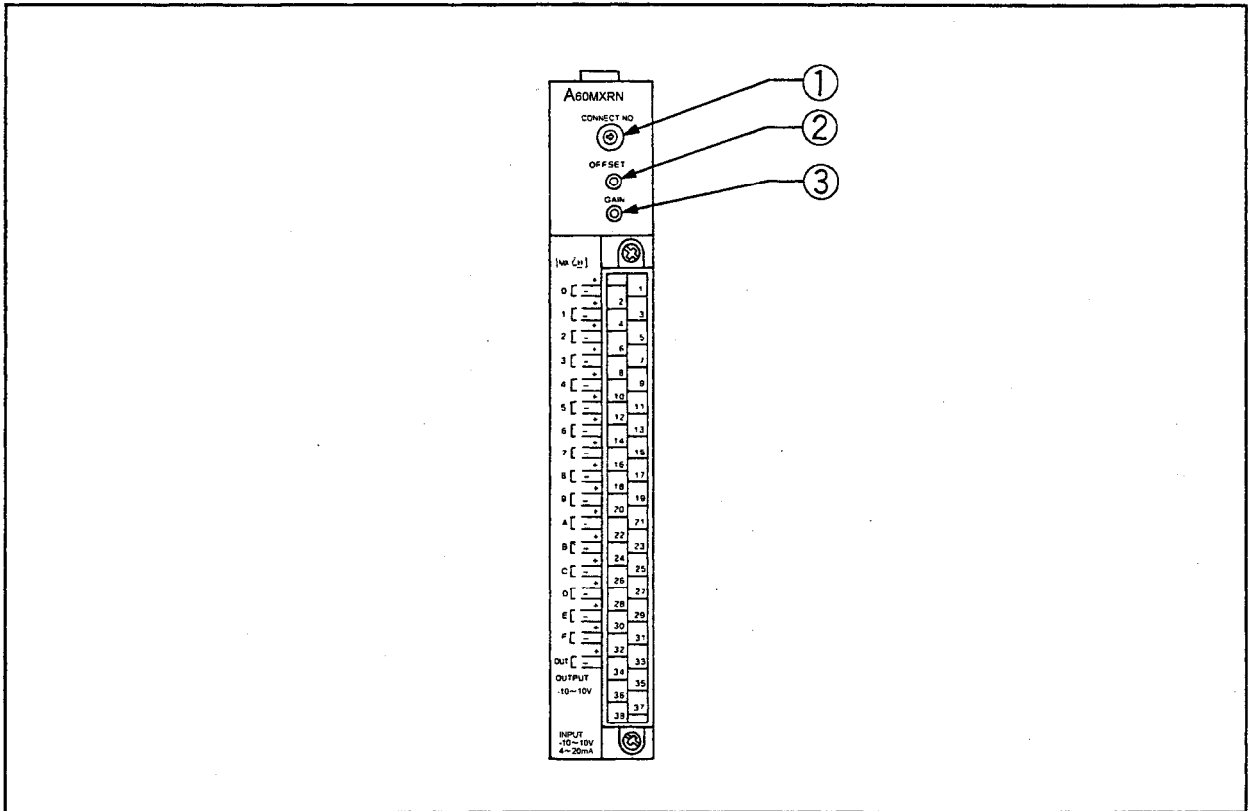
This section explains the part names and settings of the A60MXRN.



No.	Name and Appearance	Description
①	<p>CONNECT NO. switch</p> <p style="text-align: center;">CONNECT NO.</p> 	<p>Used to define the INPUT terminal of the A616AD connected with the OUT terminal of the A60MXRN.</p> <p>Setting range: 0 to 7</p>
②	<p>OFFSET control</p> <p style="text-align: center;">OFFSET</p> 	<p>Used to make microadjustment of an offset value, which is selected by the setting pins S1 and S2 in the module. For further details, see Section 4.4.</p>
③	<p>GAIN control</p> <p style="text-align: center;">GAIN</p> 	<p>Used to make microadjustment of a gain value, which is selected by the setting pins S1 and S2 in the module. For further details, see Section 4.4.</p>

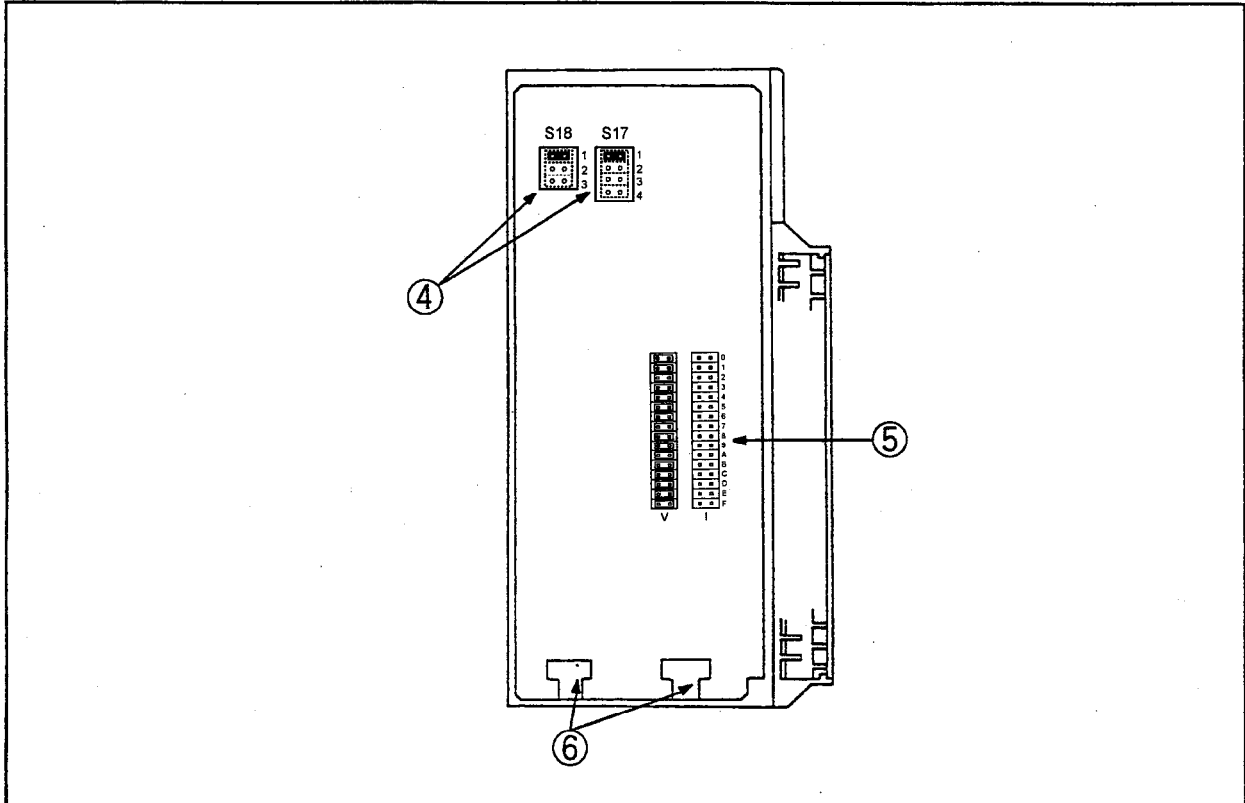

No.	Name and Appearance	Description
④	<p data-bbox="252 1081 515 1111">Offset/gain setting pins</p> <div data-bbox="347 1131 587 1279"> </div>	<p data-bbox="681 1088 1369 1167">Set the S17 and S18 setting pins in accordance with the analog input voltage/current range and A616AD offset/gain setting pin positions.</p> <p data-bbox="681 1171 1098 1200">For more information, see Section 3.4.</p>
⑤	<p data-bbox="252 1317 531 1346">Analog input select SWs</p> <div data-bbox="371 1357 515 1659"> </div>	<p data-bbox="681 1317 1417 1373">Used to select the analog input (voltage or current input) of each channel (CH0 to F).</p> <p data-bbox="711 1391 1054 1447">V position: Voltage input setting I position: Current input setting</p> <p data-bbox="687 1469 1015 1498">Factory-set in the "V" position.</p>
⑥	<p data-bbox="252 1682 547 1711">Extension cable connector</p>	<p data-bbox="681 1693 1385 1771">For connecting the extension cable of the adjacent module when increasing a channel by loading the other A60MX / A60MXR / A60MXRN next to the A60MXRN.</p> <p data-bbox="681 1776 1318 1832">The extension cable may be connected to either of the two connectors.</p>

4.4 Offset/Gain Microadjustment

An output value with respect to an analog input value is determined by selecting any of the predetermined I/O characteristics using the offset/gain setting pins which are defined in accordance with the analog input range.

The I/O characteristic selected by the offset/gain setting pins differs slightly between modules according to ambient temperature, A/D converter characteristic variations, etc.

Offset/gain microadjustment is made to correct this slight difference in characteristic.

4.4.1 A616AD offset/gain microadjustment procedure

Offset/gain microadjustment is made for 16 channels in block.

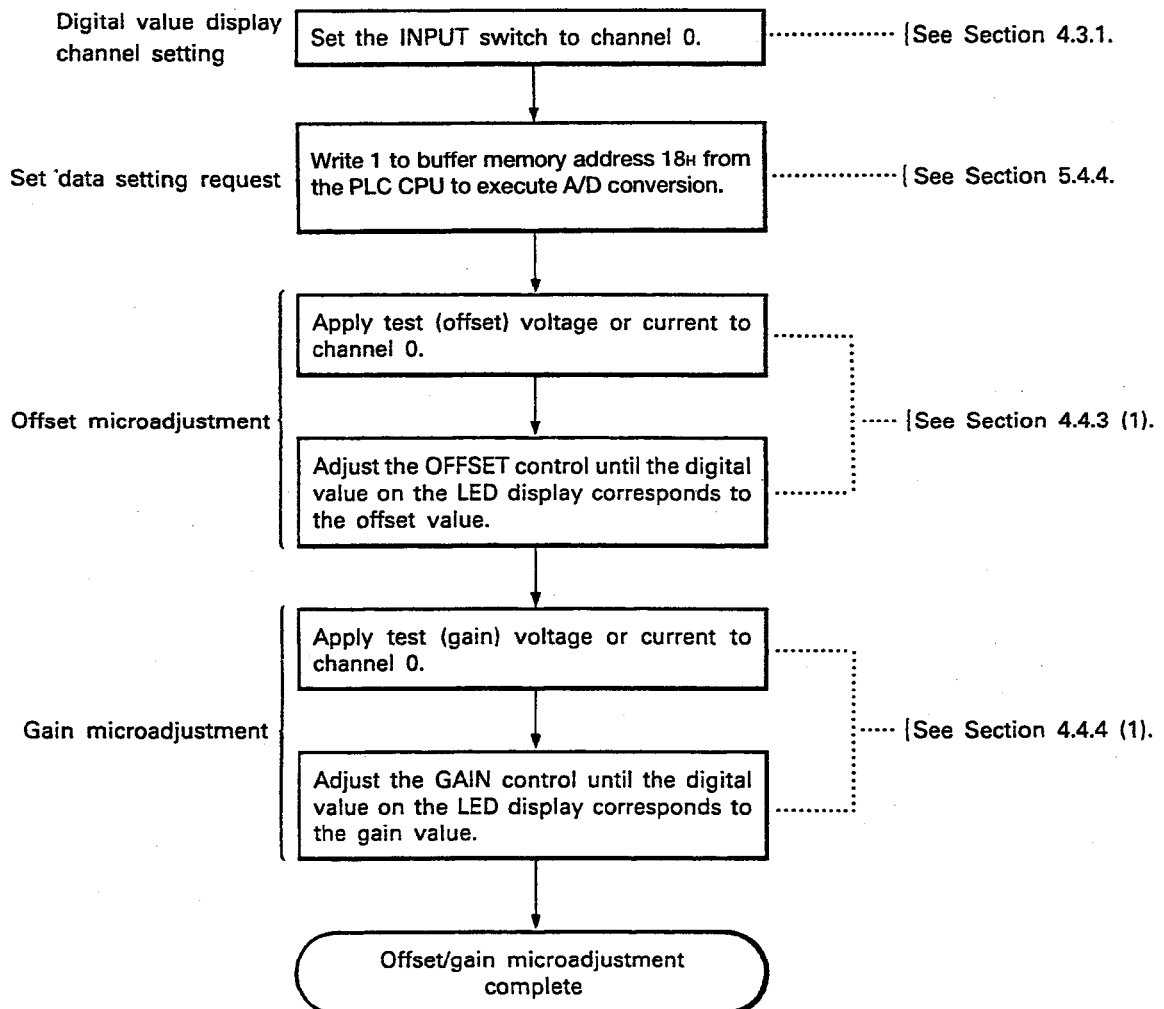

POINT

The A616AD has been preset to "S1"(analog input range 0 to 10V) by the offset/gain setting pin prior to shipment. When using a different analog input range, change the preset range to the desired one by the offset/gain setting pin and make the offset/gain adjustment.

4.4.2 A60MX/A60MXR offset/gain microadjustment procedure

Offset/gain microadjustment for the A60MX/A60MXR must be made after that for the A616AD is complete.
The offset/gain microadjustment is made for 16 channels in block.

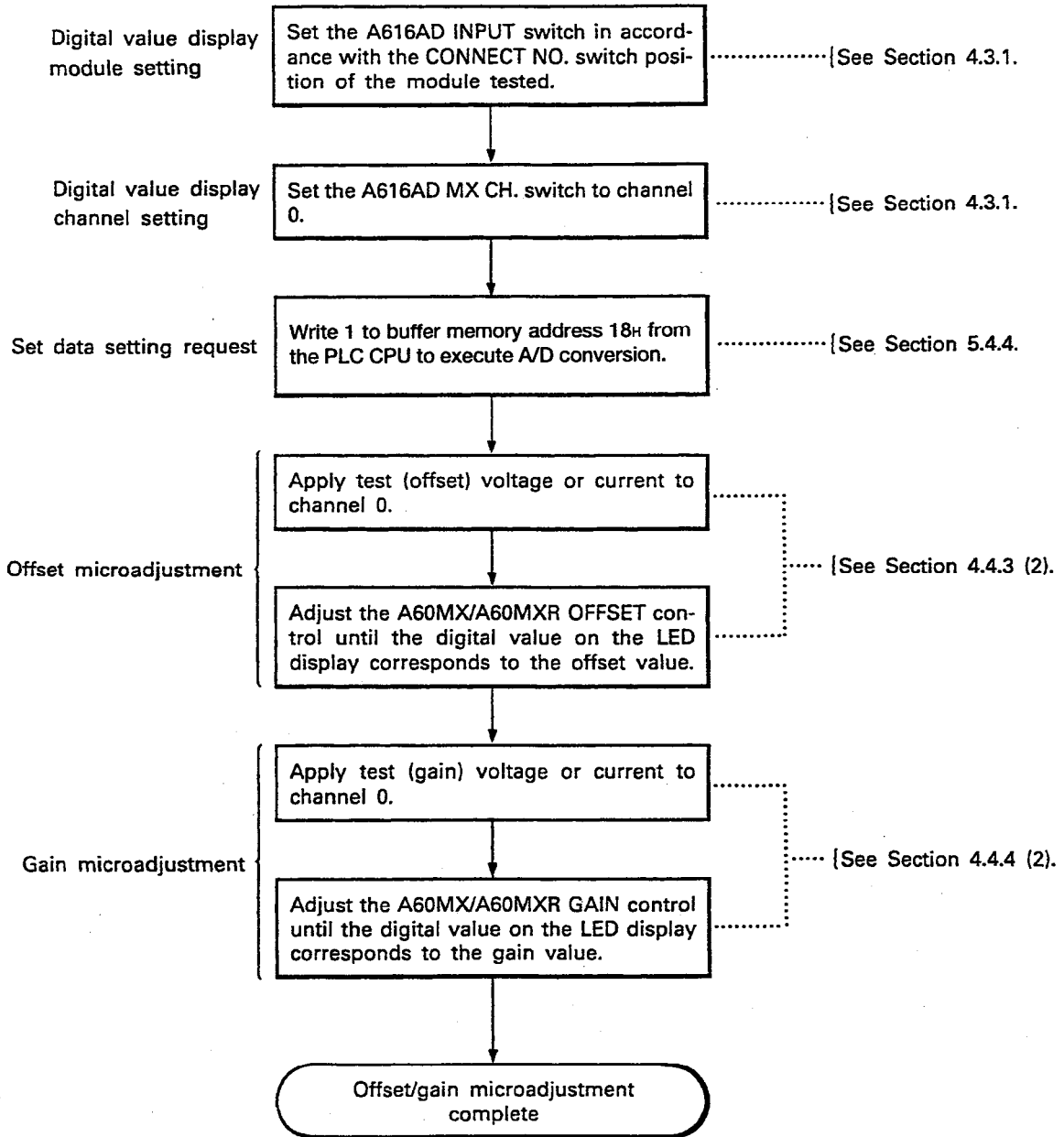

4.4.3 Offset microadjustment

Perform the offset microadjustment using the OFFSET control on the module front.

Give a test voltage or current corresponding to the offset value of the I/O characteristic that was selected using the analog input select switch or analog input select pin and the offset/gain setting pins.

Adjust the OFFSET control until the digital value on the LED display corresponds to the analog offset value entered.

(1) A616AD offset microadjustment

Offset/Gain Setting Pin Position	Analog Input Select SW Position			
	V		I	
	Test voltage (V)	Digital value	Test current (mA)	Digital value
S1	0	0	0	0
S2	0	0	0	0
S3	1	0	4	0
S4	0	2000	0	2000
S5	0	2000	0	2000

Table 4.1 A616AD Test Voltages, Currents and Digital Values

Example: When the S1 and S5 offset/gain setting pins are set to "S1" and the analog input select SW of channel 0 to "V", provide a test voltage of 0V to channel 0 and adjust the OFFSET control until the LED display indicates a digital value of 0.

(2) A60MX/A60MXR/A60MXRN offset microadjustment

A616AD	A60MX/A60MXR/A60MXRN		A60MX/A60MXR/A60MXRN Analog Input Select SW/ Pin Position			
Offset/Gain Setting Pin Position	Offset/Gain Setting Pin Position		V		I	
	S2 (S17*)	S1 (S18*)	Test voltage (V)	Digital value	Test current (mA)	Digital value
S1	1	1	0	0	0	0
	2	1	0	0	0	0
	3	2	1	0	4	0
	4	3	0	2000	0	2000
	1	3	0	2000	0	2000
S2	4	1	0	0	0	0
	1	1	0	0	0	0
S3	1	1	1	0	4	0
S4	1	1	0	2000	0	2000
	2	1	0	2000	0	2000
S5	4	1	0	2000	0	2000
	1	1	0	2000	0	2000

* For A60MXRN

Table 4.2 A60MX/A60MXR/A60MXRN Test Voltages, Currents and Digital Values

Example: When the offset/gain setting pins S1 to S5 of the A616AD are set to "S1", the A60MX, A60MXR or A60MXRN offset/gain setting pin S2 (S17) is set to "2" and S1 (S18) to "1", and the analog input select switch or analog input select pin of channel 0 of the A60MX, A60MXR or A60MXRN is set to the "V" position.

Input a test voltage of 0V to channel 0 of the A60MX, A60MXR or A60MXRN and adjust the OFFSET potentiometer of the A60MX, A60MXR or A60MXRN until the digital value of the LED display on the A616AD reaches "0".

4.4.4 Gain microadjustment

Perform the gain microadjustment using the GAIN control on the module front.

Give a test voltage or current corresponding to the gain value of the I/O characteristic that was selected using the analog input select switch or analog input select pin and the offset/gain setting pins.

Adjust the GAIN control until the digital value on the LED display corresponds to the analog gain value entered.

(1) A616AD gain microadjustment

Offset/Gain Setting Pin Position	Analog Input Select SW Position			
	V		I	
	Test voltage (V)	Digital value	Test current (mA)	Digital value
S1	10	4000	20	2000
S2	5	4000	20	4000
S3	5	4000	20	4000
S4	10	4000	20	3000
S5	5	4000	20	4000

Table 4.3 A616AD Test Voltages, Currents and Digital Values

Example: When the S1 and S5 offset/gain setting pins are set to "S1" and the analog input select pin of channel 0 to "V", provide a test voltage of 10V to channel 0 and adjust the GAIN control until the LED display indicates a digital value of 4000.

(2) A60MX/A60MXR/A60MXRN gain microadjustment

A616AD	A60MX/A60MXR/A60MXRN		A60MX/A60MXR/A60MXRN Analog Input Select SW/ Pin Position			
Offset/Gain Setting Pin Position	Offset/Gain Setting Pin Position		V		I	
	S2 (S17*)	S1 (S18*)	Test voltage (V)	Digital value	Test current (mA)	Digital value
S1	1	1	10	4000	20	2000
	2	1	5	4000	20	4000
	3	2	5	4000	20	4000
	4	3	10	4000	20	3000
	1	3	5	4000	20	4000
S2	4	1	10	4000	20	2000
	1	1	5	4000	20	4000
S3	1	1	5	4000	20	4000
S4	1	1	10	4000	20	3000
	2	1	5	4000	20	4000
S5	4	1	10	4000	20	3000
	1	1	5	4000	20	4000

* For A60MXRN Table 4.4 A60MX/A60MXR/A60MXRN Test Voltages, Currents and Digital Values

Example: When the offset/gain setting pins S1 to S5 of the A616AD are set to "S1", the A60MX, A60MXR or A60MXRN offset/gain setting pin S2 (S17) is set to "1" and S1 (S18) to "1", and the analog input select switch or analog input select pin of channel 0 of the A60MX, A60MXR or A60MXRN is set to the "V" position.

Input a test voltage of 10V to channel 0 of the A60MX, A60MXR or A60MXRN and adjust the GAIN potentiometer of the A60MX, A60MXR or A60MXRN until the digital value of the LED display on the A616AD reaches "4000".

4.5 Wiring Instructions

Protect external wiring against noise with the following precautions:

- (1) Separate AC and DC wiring.
- (2) External wiring must be at least 10cm (0.4 inches) away from main circuit and/or AC control circuit wiring.
- (3) Separate external wiring sufficiently from high voltage wiring and any circuit that includes harmonics, e.g. main circuit of inverter load.
- (4) Ground the shielding of all wires to a common ground point.

4.6 Module Connection Examples

The following diagrams show the voltage input and current input wiring examples of the A616AD, A60MX and A60MXR.

4.6.1 Wiring examples for A616AD used alone

The following diagram shows the voltage input and current input wiring examples of the A616AD.

(1) Voltage input

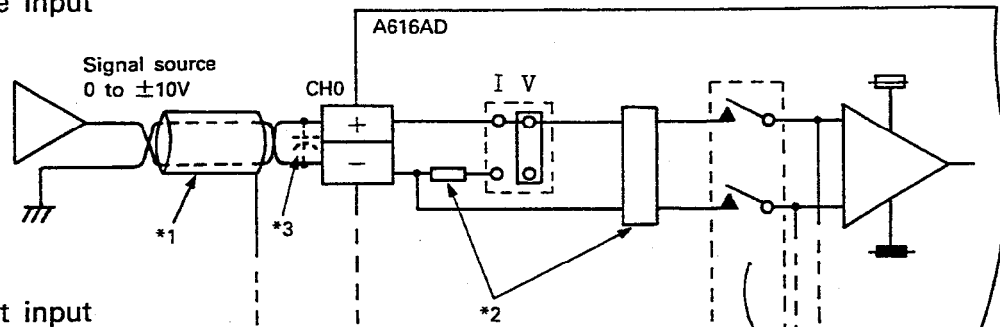

(2) Current input

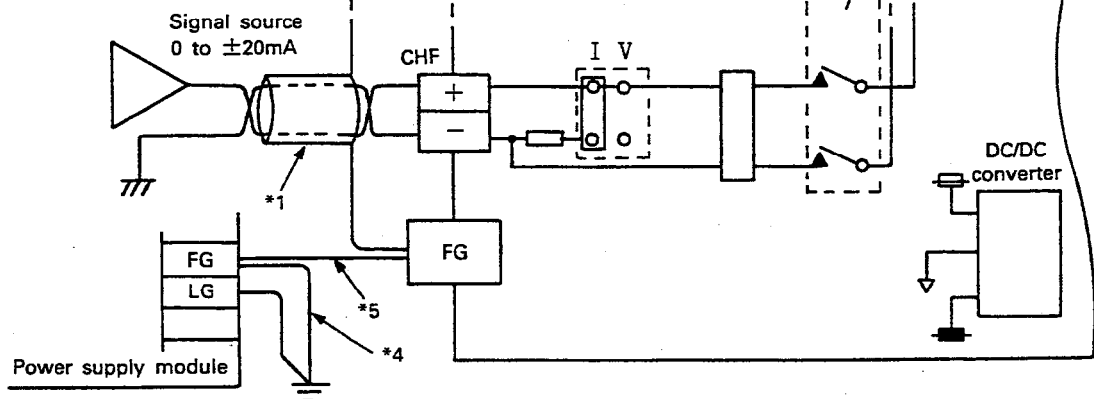

- *1: For the cable, use a two-core twisted shielded wire.
- *2: Indicates the input resistance of the A616AD.
- *3: If noise or ripple is generated at the external wiring, connect a capacitor of approx. 0.1 to 0.47 μ F (25V or more voltage resistance parts) between terminals + and -.
- *4: Always ground the FG and LG terminals of the power supply module.
- *5: FG of the A616AD and FG of the power supply module must be connected.

4.6.2 Wiring example for A616AD used with A60MX/A60MXR

The following diagram shows the voltage input and current input wiring examples of the A616AD connected with the A60MX or A60MXR.

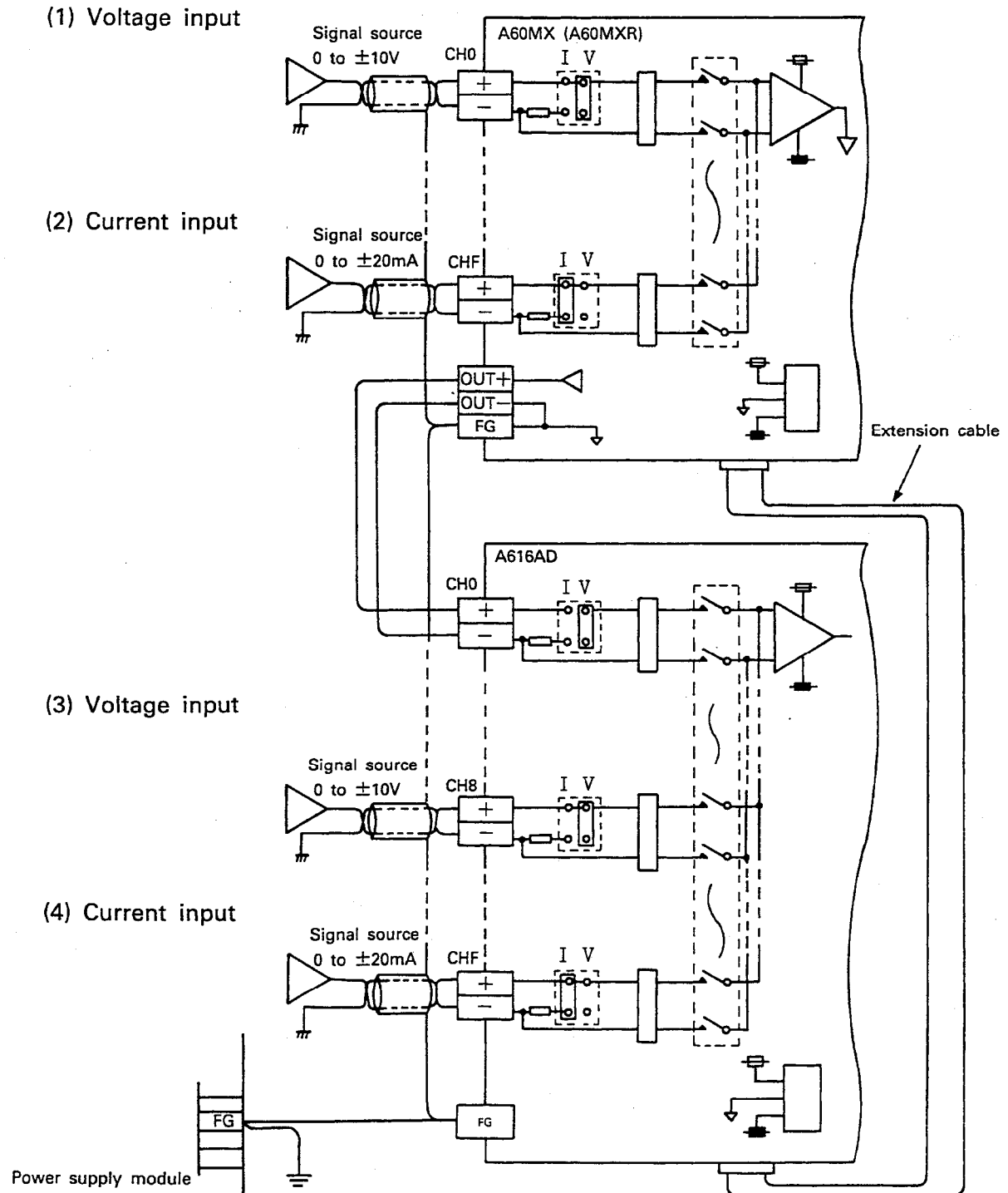

POINT
Up to seven A60MX and/or A60MXR modules may be connected to any of CH0 to 7 of the A616AD.

5. PROGRAMMING

5.1 I/O List for PLC CPU

The A616AD uses 32 input and 32 output points for communication of data with the PLC CPU. I/O signal assignment and functions are as follows.

Device X indicates an input signal from the A616AD to the PLC CPU and device Y an output signal from the PLC CPU to the A616AD. I/O numbers used in this manual assume that the A616AD is located at slot 0 of the main base.

When applying any of the program examples introduced in this chapter to the actual system, verify the applicability and confirm that no problems will occur in the system control.

Input Signal	Name	Description
X0	Watch dog timer error	Switched on when a watch dog timer error occurs in the A616AD.
X1	A/D conversion ready	(1) Switched off when 1 is set to the set data setting request area (address 18). Switched on when A/D conversion is ready. (2) Used as an interlock when reading data from the PLC CPU to the A616AD.
X2	Error flag	Switched on when any other error than the watch dog timer error occurs in the A616AD. (1) Switched on when the corresponding error code is written to the buffer memory error code area (address 5). (2) To reset the error, write 0 to the error code area from the PLC CPU.
X3 to X1C	—	Reserved.
X1D to X1F	RFRP , RTOP instruction interlock signals	Only used when the A616AD is used on a remote I/O station. (For full information, see the Data Link System User's manual.)

Table 5.1 Input Signals

Output Signal	Name	Description
Y0 to YC	—	Reserved.
YD to YF	RFRP , RTOP instruction interlock signals	Only used when the A616AD is used on a remote I/O station. (For full information, see the Data Link System User's manual.)
Y10 to Y17	—	Reserved.
Y18	Direct access request	Switched on by the PLC CPU when direct access is made.
Y19 to Y1F	—	Reserved.

Table 5.2 Output Signals

IMPORTANT

Outputs Y0 to YC, Y10 to Y17, Y19 to Y1F are reserved, they should not be used in the sequence program.
Y0 to Y1F corresponding to X0 to X1F cannot be used as internal relays.

POINT

During each of the processes of the special function module, access from the PLC CPU will have priority.

Accordingly, if frequent access to the buffer memory of the special function module made from the PLC CPU, it will not only extend the scan time of the PLC CPU, delays in each of the processes of the special function module will occur.

Only use the FROM/TO and other such commands to access the buffer memory from the PLC CPU when necessary.

(1) Watch dog timer (X0)

On indicates that the A616AD has self-detected a watch dog timer error and stops the A/D conversion of the A616AD. The watch dog timer error indicates an A616AD hardware fault.

(2) A/D conversion ready (X1)

Switched on when the set data is made valid by writing "1" to the set data setting request area of the buffer memory with the sequence program.

Switched off by writing "1" again to the set data setting request area during A/C conversion and switched on again when A/D conversion is ready after data check.

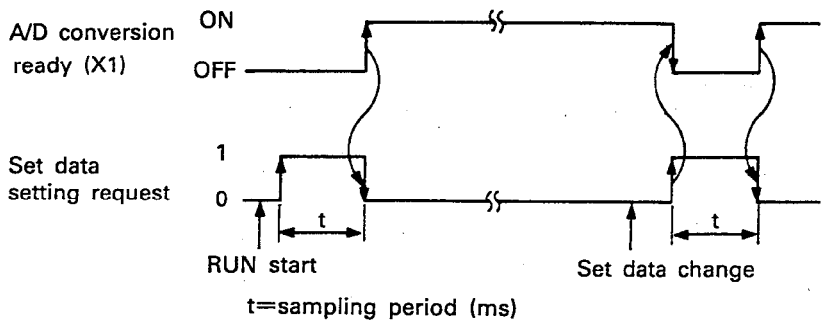

(3) Error flag (X2)

On indicates that an error other than the watch dog timer error has occurred in the A616AD and the corresponding error code has been stored to the error code area.

Switched off by writing "0" to the error code area by the sequence program.

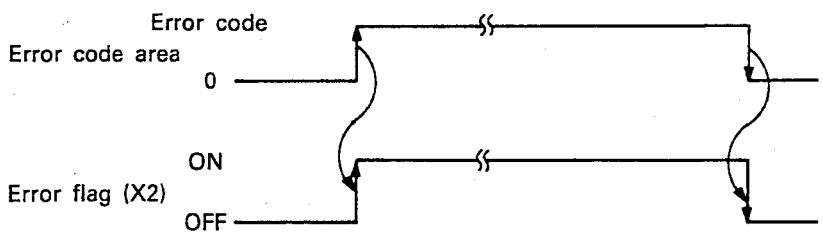

(4) Direct access request signal (Y18)

Switched on to allow direct access to the channel specified at buffer memory addresses 0_H and 1_H and store the digital value to address 2_H.

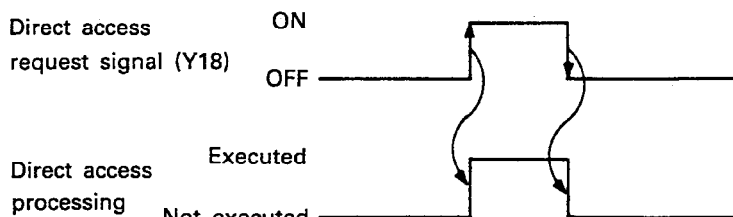

5.2 Buffer Memory

The A616AD has a buffer memory (not battery backed) for communication of data with the PLC CPU.

The assignment and data make-up of this buffer memory will be described below.

5.2.1 Buffer memory assignment

The buffer memory assignment is shown below.

Address (Hexadecimal)		Communication with PLC CPU		Refer To	
		Write only	Read only		
0H	Direct access	INPUT designation	○	Section 5.6	
1H		MX. CH. designation	○		
2H		Digital output value			○
3H	Sampling period designation		○	Section 5.4.1	
4H	Data format selection		○	Section 5.4.2	
5H	Error code storage		○	Section 5.8	
6H	Faulty multiplexer module CNT. No. storage		○	Section 5.7	
7H to EH	Reserved		—	—	
FH	Conversion enable/disable designation	A616AD	○	Section 5.4.3	
10H		INPUT 0 A60MX, A60MXR			
11H		INPUT 1 A60MX, A60MXR			
12H		INPUT 2 A60MX, A60MXR			
13H		INPUT 3 A60MX, A60MXR	○		
14H		INPUT 4 A60MX, A60MXR			
15H		INPUT 5 A60MX, A60MXR			
16H		INPUT 6 A60MX, A60MXR			
17H		INPUT 7 A60MX, A60MXR			
18H	Set data setting request		○	Section 5.4.4	
19H to 30H	Reserved		—	—	
31H to 3FH	INPUT channel digital output value			○	Section 5.5
40H to 9FH	Reserved		—	—	
100H to 17FH	MX CH. channel digital output value			○	Section 5.5

IMPORTANT

Addresses 2H, 7H to EH, and 19H to 17FH are only used to read data from the PLC CPU. Data should not be written to these address. Error code 10 is displayed and the RUN LED flicker if data is written.

5.3 Programming Procedure

Write an analog-to-digital conversion program in the following procedure:

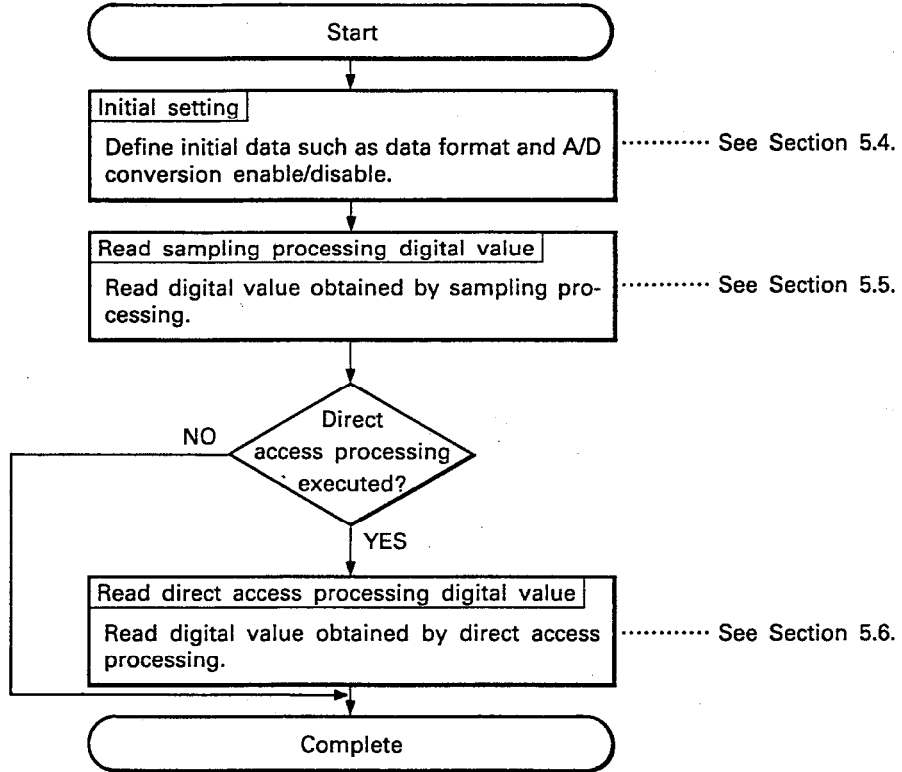

5.4 Initial Setting

The initial setting program given below must be written before the digital output value read program.

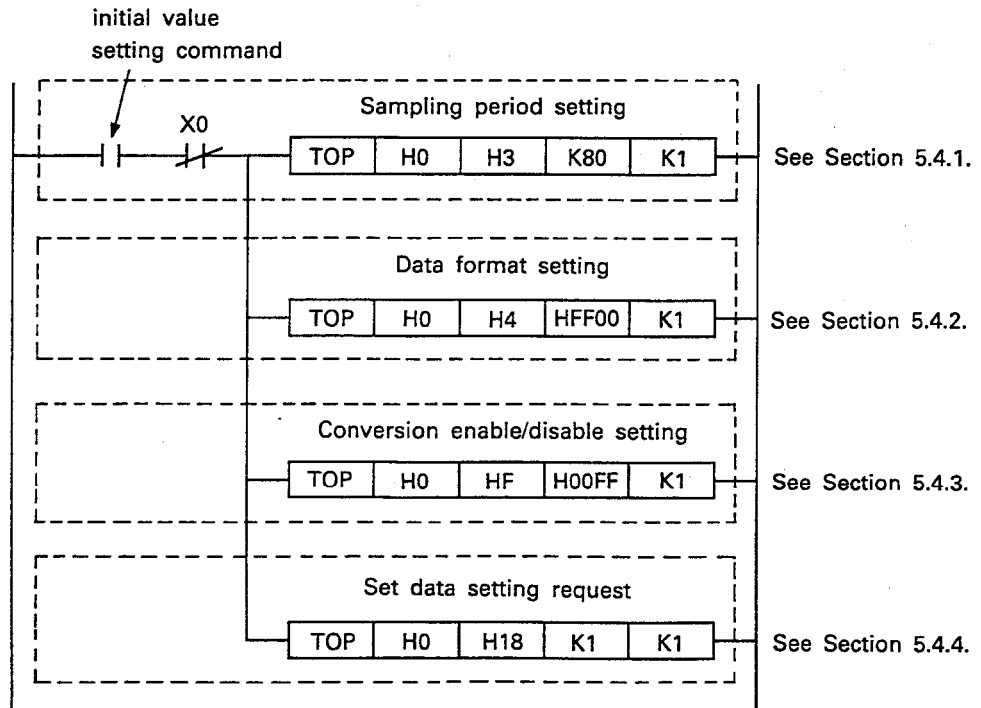

5.4.1 Setting the sampling period

The sampling period of the A616AD and A60MX is fixed at $1\text{ms} \times$ (number of channels). As the A60MXR uses a mercury-plunger relay as a channel select switch, the life of this mercury-plunger relay must be kept longer than the required.

There are no restrictions on the life cycle of the photo MOS relay used as the channel select switch of the A60MXRN.

Write the (required sampling period) \times (number of channels specified for A/D conversion) to the buffer memory address 3_H as a sampling period.

The shorter the defined sampling period is, the shorter the mercury-plunger relay life is.

For the relation between the sampling period and mercury-plunger relay life, see Section 3.10.

- (1) The sampling period defaults to 784ms. When this value is used, the setting program is not required.
- (2) The sampling period is a value equal to or greater than $7\text{ms} \times$ (number of channels specified for A/D conversion) and may be defined between 7 and 30,000ms in 1m increments.

POINT

(1) It is not necessary to define the sampling period if:

- a) The A616AD is used alone
- b) The A616AD is used with the A60MX; or
- c) The A616AD is used with the A60MXR (and A60MX) and the A60MXR sampling period used is the default value.

(2) Writing any invalid value results in an error and causes the following operations:

- a) Processing continues with the default value or preceding set value.
- b) The LED display indicates error code "11".
- c) Error code "11" is stored in binary to buffer memory address 5_H .
- d) The RUN LED flickers. See Section 5.8 to reset.

5.4.2 Setting the data format

Set either of “-48 to 4047” or “-2048 to 2047” data format to each channel and write the set value to the buffer memory address 4_H.

- (1) The data format defaults to all-channel data format “-48 to 4047”.
- (2) The data format area has 16 bit locations as shown below:

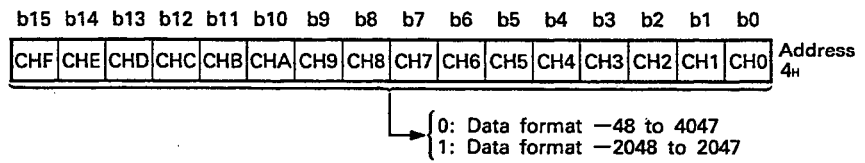

- (3) The A616AD allows the data format to be set for each channel but the A60MX/A60MXR only allows the data format to be set for all 16 channels.

POINT

It is not necessary to define the data format when all channels are used in data format “-48 to 4047”.

5.4.3 Specifying A/D conversion enable/disable

Define A/D conversion enable/disable per channel of the A616AD, A60MX and A60MXR and write the set value to the buffer memory addresses F_H to 17_H.

The sampling period can be reduced by disabling unused channels from conversion.

- (1) At power on or PLC CPU reset, all channel conversion enable is written as a default value to buffer memory address F_H and INPUT address 10_H-17_H to which the A60MX/A60MXR is connected.
- (2) The A/D conversion enable/disable area has 16-bit locations as shown below:

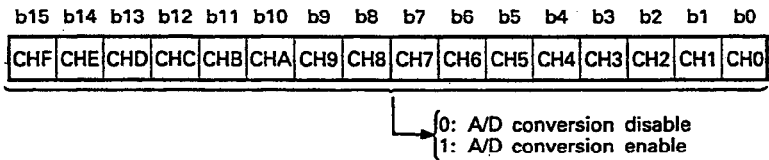

POINT

- (1) Sampling period can be reduced by enabling used channels only.
- (2) "0" (A/D conversion disable) is automatically written to the channels which are not connected with the A60MX/A60MXR.

5.4.4 Set data setting request

Always write "1" to address 18H of the buffer memory when you wrote the set data for sampling period, data format and analog-to-digital conversion enable designation to the buffer memory at the initial setting or during analog-to-digital conversion.

When "1" is written to this area, the analog-to-digital conversion ready signal turns off, the set data written to the buffer memory is set to the set data dedicated storage memory, and after the data of all channels have been checked, the analog-to-digital conversion ready signal turns on to start analog-to-digital conversion.

- (1) Analog-to-digital conversion is not started unless "1" is written to this area at the initial setting.
Write "1" when starting analog-to-digital conversion with the default value.
- (2) When the set data is changed during analog-to-digital conversion, analog-to-digital conversion continues under the previous conditions if "1" is not written to this area.
- (3) The timings of the set data setting request signal and analog-to-digital conversion ready signal are as shown below.

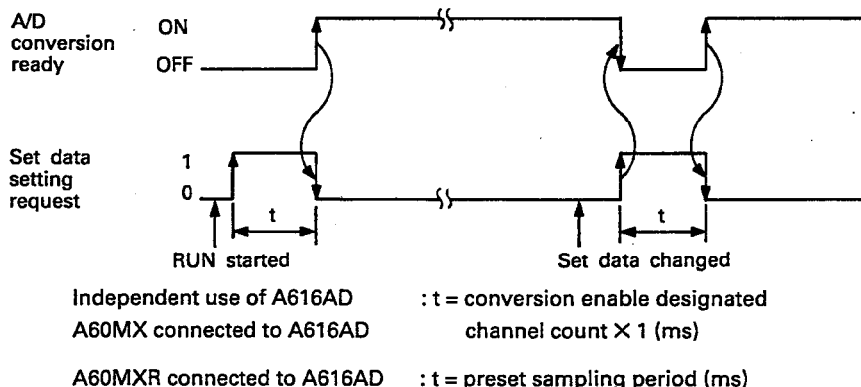

- (4) "1" written to the set data setting request area changes to "0" automatically when the analog-to-digital conversion ready signal turns on.
- (5) Writing any value other than "1" to the setting area will cause a setting error to occur, the error code 12 to be stored into address 5H of the buffer memory, and the following operation status to take place.

At initial setting: Analog-to-digital conversion is not made.
During analog-to-digital conversion: Processing continues under the previous conditions.

After a correct value has been set, the error code remains stored in the buffer memory. Therefore, write "0" to the buffer memory address 5H from the PLC CPU to clear the error code.

5.5 Reading the Sampling Processing Output Values

Sampling processing allows A/D conversion to be made for each channel of the A616AD and A60MX/A60MXR and digital output values to be written to the buffer memory.

The digital output value of any channel can be read by specifying the corresponding buffer memory address from the PLC CPU.

- (1) The digital output value area is divided into the A616AD INPUT channel area and the A60MX/A60MXR MX CH. channel area.
- (2) Each of the above two areas has 16-bit locations as shown below:

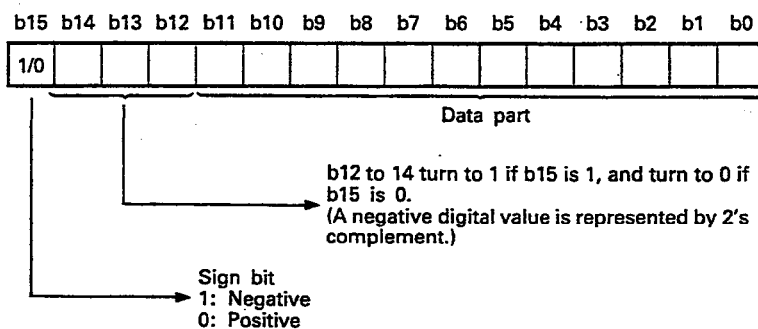

(3) Data in the INPUT channel area differs when the corresponding INPUT channel is connected with an external sensor and when it is connected with the A60MX/A60MXR.

(a) INPUT channel connected with external sensor

A digital value with respect to an analog input value from the external sensor is written to the INPUT channel area.

(b) INPUT channel connected with A60MX/A60MXR

A digital value for MX CH. 0 of the A60MX/A60MXR is written to the INPUT channel area.

Fig. 5.1 shows details of the digital output value area for INPUT channels.

Address	
30 _H	INPUT 0 digital output value
31 _H	INPUT 1 digital output value
32 _H	INPUT 2 digital output value
33 _H	INPUT 3 digital output value
34 _H	INPUT 4 digital output value
35 _H	INPUT 5 digital output value
36 _H	INPUT 6 digital output value
37 _H	INPUT 7 digital output value
38 _H	INPUT 8 digital output value
39 _H	INPUT 9 digital output value
3A _H	INPUT A digital output value
3B _H	INPUT B digital output value
3C _H	INPUT C digital output value
3D _H	INPUT D digital output value
3E _H	INPUT E digital output value
3F _H	INPUT F digital output value

Fig. 5.1 INPUT Channel Digital Output Value Area

(4) Digital output values for the A60MX/A60MXR channels are written to the MX CH. channel area as shown in Fig. 5.2.

Address		
100 _H	CNT. No. 0	MX CH. 0 digital output value
101 _H		MX CH. 1 digital output value
102 _H		MX CH. 2 digital output value
⋮		⋮
10F _H		MX CH. F digital output value
110 _H	CNT. No. 1	MX CH. 0 digital output value
111 _H		MX CH. 1 digital output value
112 _H		MX CH. 2 digital output value
⋮		⋮
11F _H		MX CH. F digital output value
⋮		⋮
170 _H	CNT. No. 7	MX CH. 0 digital output value
171 _H		MX CH. 1 digital output value
172 _H		MX CH. 2 digital output value
⋮		⋮
17F _H		MX CH. F digital output value

Fig. 5.2 MX CH. Channel Digital Output Value Area

5.6 Reading the Direct Access Processing Output Value

By writing the directly-accessed channel number to the buffer memory addresses 0_H and 1_H and switching on the direct access request flag Y18, direct access processing is executed and the digital output value is written to the buffer memory address 2_H.

- (1) To perform direct access processing for any of the A616AD channels, write the corresponding INPUT number to the buffer memory address 0_H.

It is not necessary to write data to the buffer memory address 1_H.

The setting range is as follows:

INPUT number 0 to F_H

- (2) To perform direct access processing for any of the A60MX/A60MXR channels, write the CNT. number of the corresponding module to the buffer memory address 0_H, and write the MX CH. number of the corresponding channel to the buffer memory address 1_H.

The setting ranges are as follows:

CNT. number 0 to 7_H

MX CH. number 0 to F_H

- (3) The numbers default to 0.

- (4) By writing the directly-accessed channel number to the buffer memory and switching on the direct access processing request flag Y18, A/D conversion is executed for the specified channel and the digital output value is written to the buffer memory address 2_H.

For the processing time, see Section 3.7.

- (5) The digital output value has 16 bit locations as shown below:

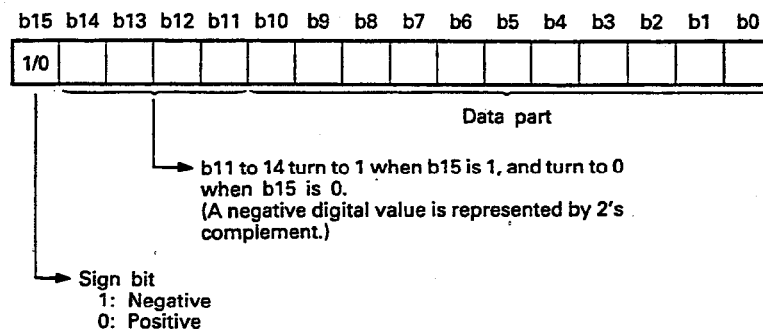

(6) Program example

The following example gives a direct access request to channel 5 of the A60MX which is connected to the A616AD channel 0.

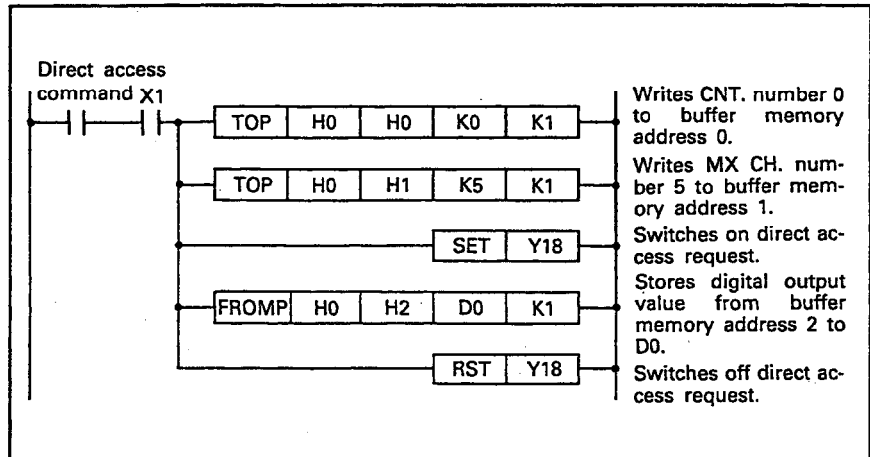
**POINT**

- (1) If direct access processing is requested for the A60MXR channel, the scan time increases 7ms, which is the processing time of the **FROM** instruction.
- (2) Writing an invalid value changes the buffer memory data and results in an error with the following operations:
 - a) Direct access processing stops.
 - b) Error code 20 is displayed if the invalid value is written to the buffer memory address 0.
Error code 21 is displayed if the invalid value is written to the buffer memory address 1.
 - c) The RUN LED flickers. See Section 5.8 to reset.
 - d) Sampling processing continues.

5.7 Reading the Error Code

When the A616AD detects an error, the corresponding binary error code is written to the buffer memory address 5_H.

- (1) Address 5_H is overwritten by the most recent error code.
- (2) "1" is written to the bit corresponding to the CNT. number at buffer memory address 6_H if an error corresponding to any of the error codes 01 to 03 occurs due to the A60MX/A60MXR module fault, setting error, etc.
If a new error occurs, "1" is written over the bit corresponding to the CNT. number until this area is cleared.

1) This area has 16 bit locations as shown below:

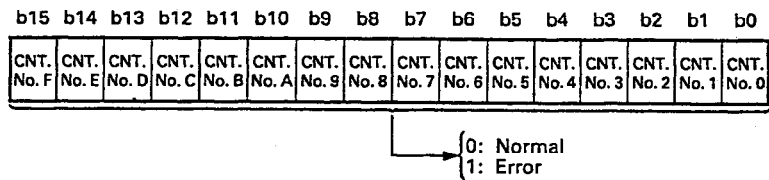

5.8 Clearing the Error Code Area

- (1) The detected data remains stored in the buffer memory after the error is removed. Clear the detected data by writing 0 to the buffer memory addresses 5_H and 6_H from the sequence program. (See Section 5.7.)

5.9 Programming for ACPU Remote I/O Station

When the A616AD is used on a remote I/O station, the master station (ACPU) should be programmed as described below.

5.9.1 Programming instructions

The ACPU is controlled in direct or refresh I/O mode but data communication with a remote I/O station is made in batch refresh mode after the **END** (FEND) instruction is executed.

For full information on data link, see the Data Link System User's Manual.

- (1) Control timing must be noted. Since data is controlled via the link module, some delay may occur for communication of control data between the master station CPU and the A616AD on the remote I/O station.
- (2) The following instructions are used for data communication with the A616AD on the remote I/O station:

Data write from master station to remote I/O station A616AD:

RTOP instruction

Data read from remote I/O station A616AD to master station:

RFRP instruction

Data transfer between the master station CPU and A616AD is made by the link register (W). Hence, an appropriate program should be written so that the link register data is transferred to the other device after the **RFRP** instruction has been executed, and the required data is transferred to the link register before the **RTOP** instruction is executed.

- (3) The **RTOP** and **RFRP** instructions cannot be executed at the same time (within one scan) to one A616AD on the remote I/O station.

The signals on the following page must be used with the **RTOP** and **RFRP** instructions as interlock conditions.

The I/O signal numbers indicated are those assigned by the master station and correspond to X0 to X1F and Y0 to Y1F in this example.

- (4) Control signals to remote I/O station

- Y₀₀ may not be provided to the remote I/O station by PLS Y₀₀ because of the relation between the master station scan time and link scan time.
- After the **SET** instruction is executed, the pulse output for executing the **RST** instruction cannot be used because data communication between the master station and remote I/O station is made in batch refresh mode after the **END** (FEND) instruction is executed.

- (5) Among the link registers (M→R) specified in the link parameter setting, do not use the link registers (beginning with the first one) equivalent to the number of special modules loaded in the remote station.

Signal Direction: PLC CPU to A616AD		Signal Direction: A616AD to PLC CPU	
Device number	Signal	Device number	Signal
Y ₀ to Y _c	Reserved.	X ₁₀ to X _{1c}	Reserved.
Y _D	Used to switch off X _{1D} .	X _{1D}	Switched on if the [RFRP] or [RTOP] instruction cannot be executed due to a special function module fault.
Y _E	Switched on by the master station CPU when the [RFRP] instruction is executed (data is transferred from the master station CPU to the link module). Must be reset by the user program after checking that X _{1E} is on.	X _{1E}	ON while the A616AD in the remote station is processing the [RFRP] instruction.
Y _F	Switched on by the master station CPU when the [RTOP] instruction is executed (data is transferred from the master station CPU to the link module). Must be reset by the user program after checking that X _{1F} is on.	X _{1F}	ON while the A616AD in the remote station is processing the [RTOP] instruction.

Timing

[RTOP], **[RFRP]** instruction cannot be executed due to a special function module fault

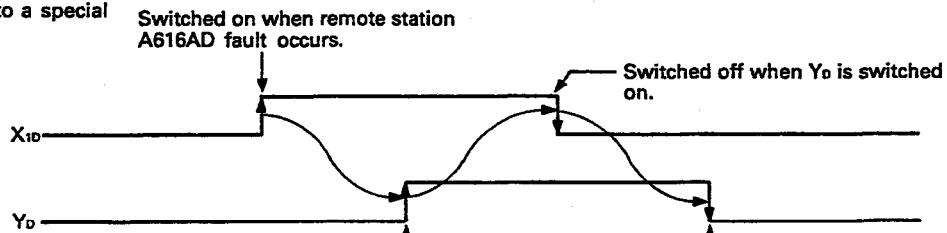

[RFRP] instruction is executed

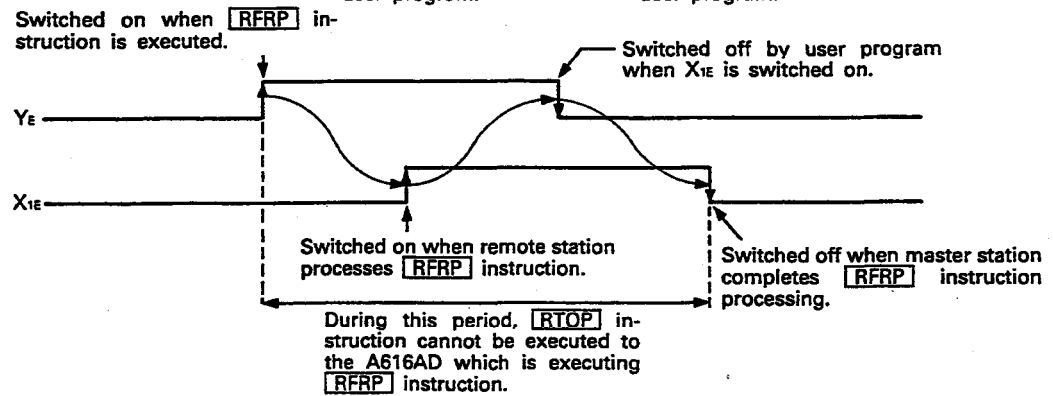

RTOP instruction is executed

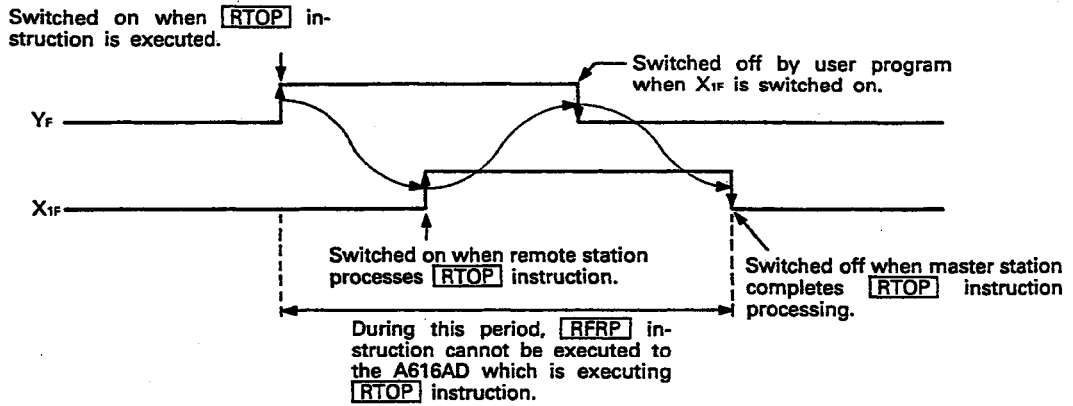

5.9.2 Basic programs for read and write

(1) Read from remote I/O station A616AD

Format

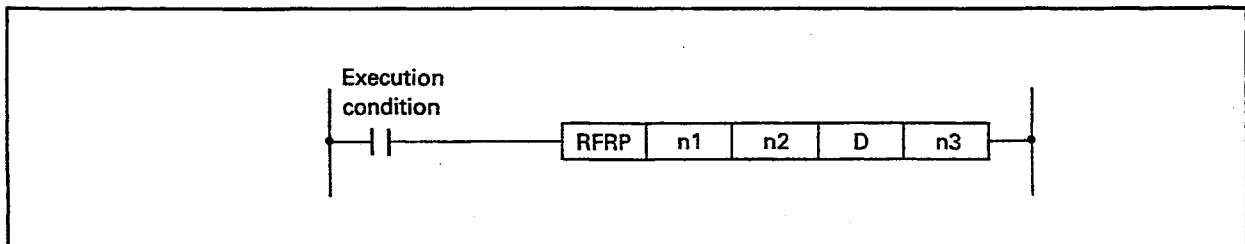

Symbol	Description	Device Used
n1	I/O number assigned to A616AD by master station	K, H
n2	Head address of A616AD buffer memory which stores data	K, H
D	Head number of link register which will store read data	W
n3	Number of words of data read (1 to 16)	K, H

POINT

The number of digits of the head I/O signal, n1, is three for the **RFRP** and **RTOP** instructions.

Example: To read 1 word to W53 from the buffer memory address 30 (digital output value) of the remote I/O station A616AD assigned to X, Y130 to 14F by the master station.

To execute read only once by switching on the read signal

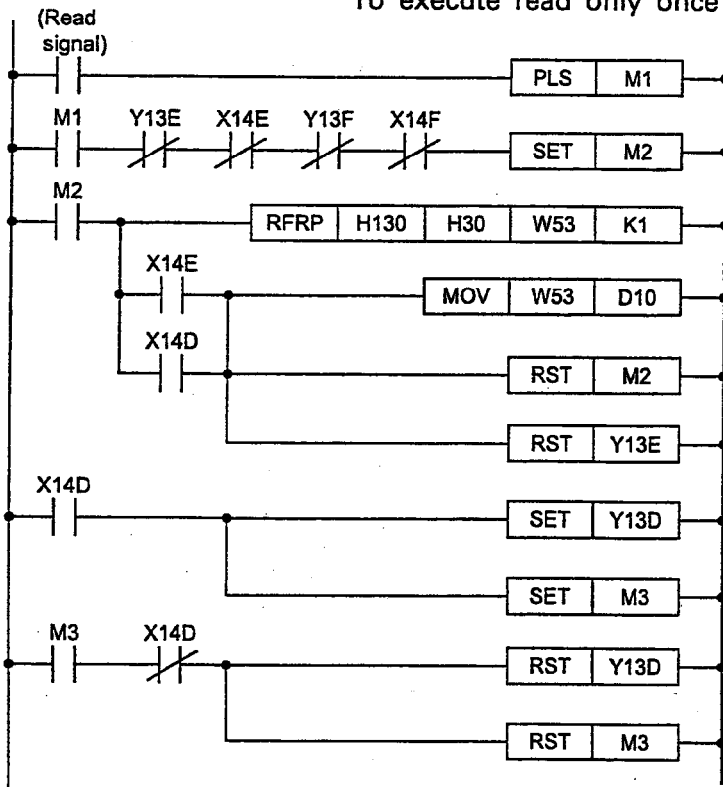

Interlock conditions for executing RFRP (Y13E, X14E, Y13F, X14F)

Transfers data as X14E is switched on when remote station executes RFRP instruction.

Resets RFRP instruction execution command.

Resets RFRP instruction execution frag.

To continuously execute read while the read signal is on (Executed per two scans)

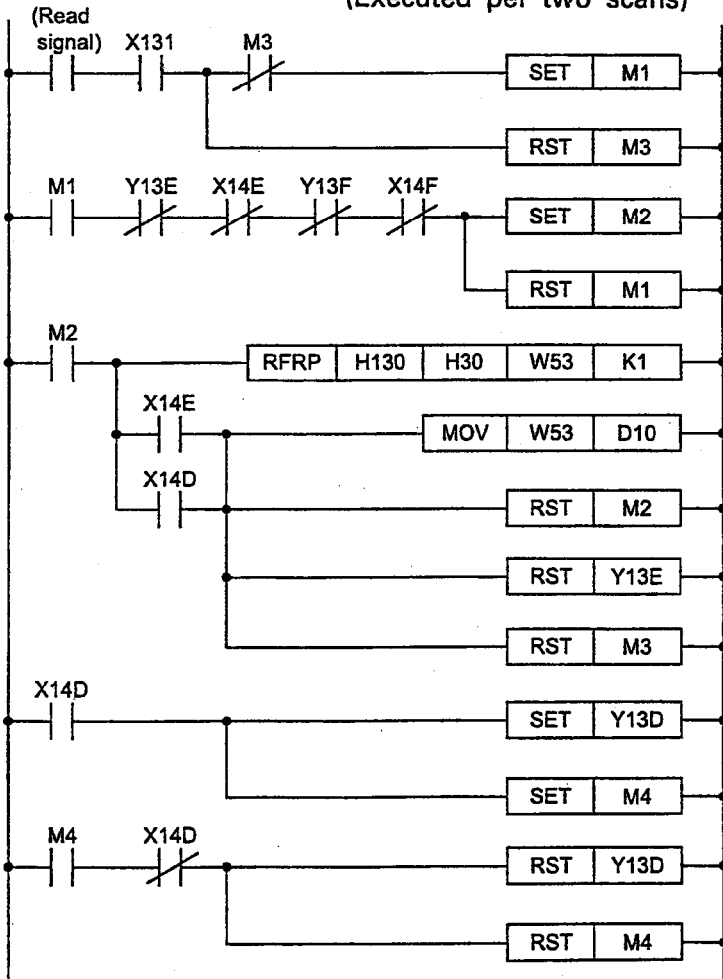

Interlock conditions for executing RFRP (Y13E, X14E, Y13F, X14F)

Transfers data as X14E is switched on when remote station executes RFRP instruction.

Resets RFRP instruction execution command.

Resets RFRP instruction execution frag.

Generates pulse for repetition.

(2) Write to remote I/O station A616AD

Format

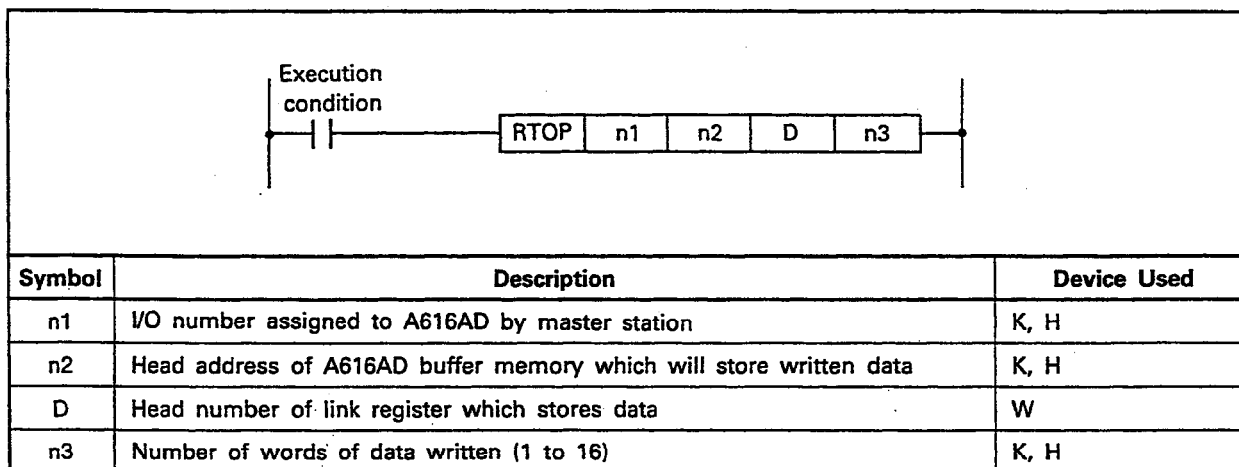

POINT

The number of digits of the head I/O signal, n1, is three for the **RFRP** and **RTOP** instructions.

Example: To write 1 word from W51 to the buffer memory address 18 (set data setting request) of the remote I/O station A616AD assigned to X, Y130 to 14F by the master station.

To execute write only once by switching on the write signal

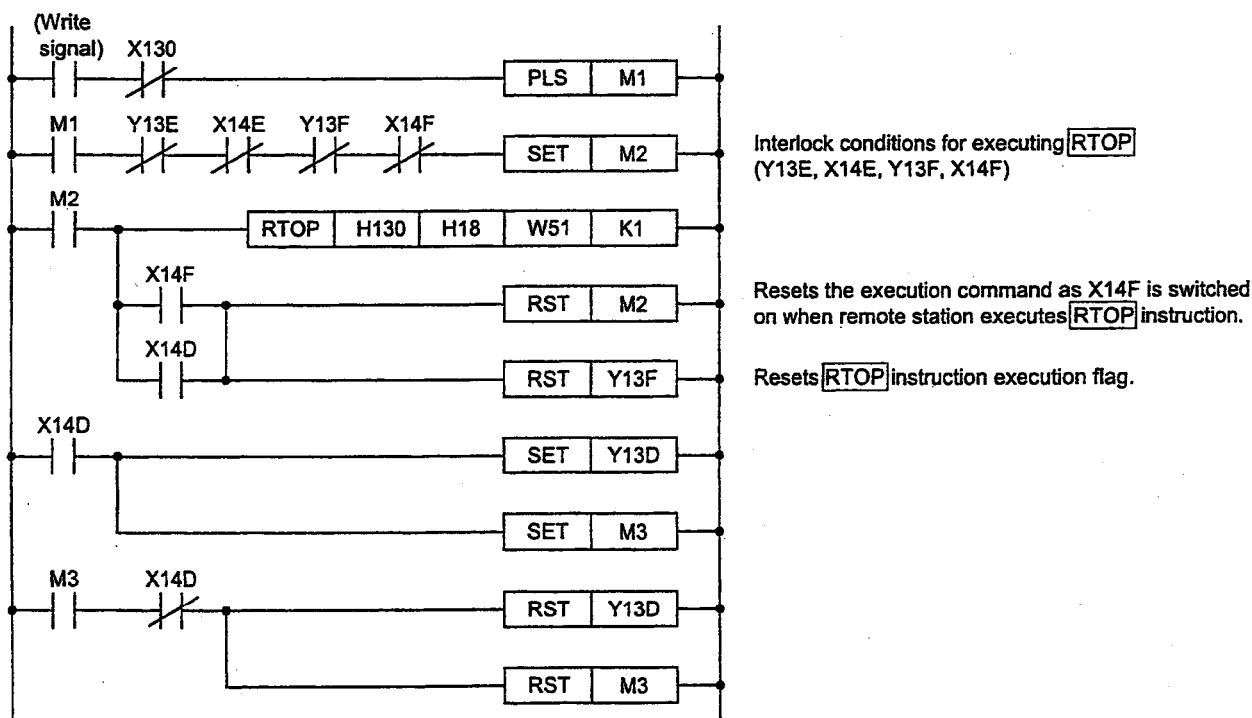

(3) Reading continuously from remote I/O station A616AD and writing set data

Example: To disable the A616AD INPUT 2 from A/D conversion during continuous read of 1 word to W53 from the buffer memory address 30_H (digital output value) of the remote I/O station A616 assigned to X, Y130-14F by the master station, and after defining disable, to read data from the buffer memory address 30_H again.

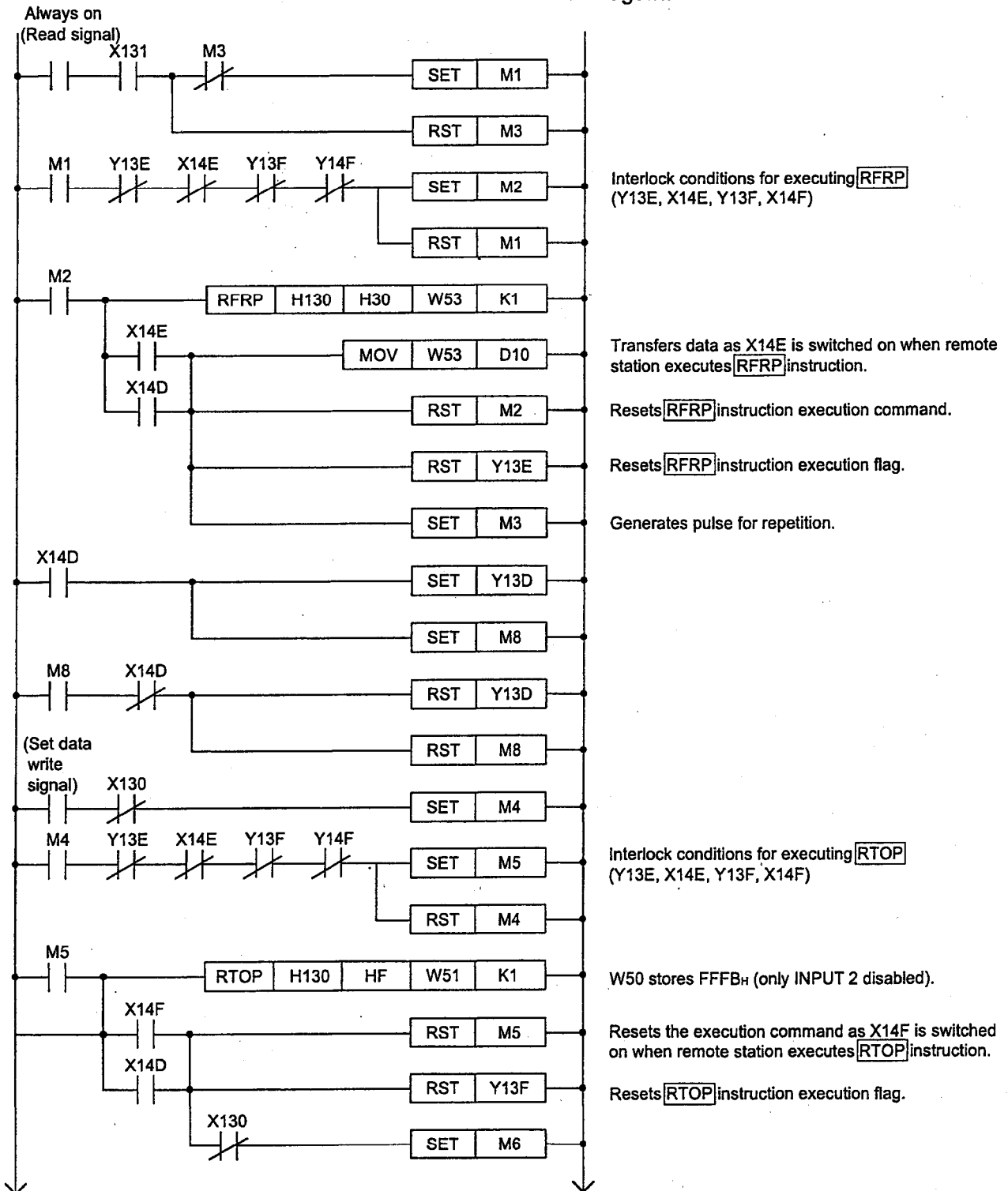

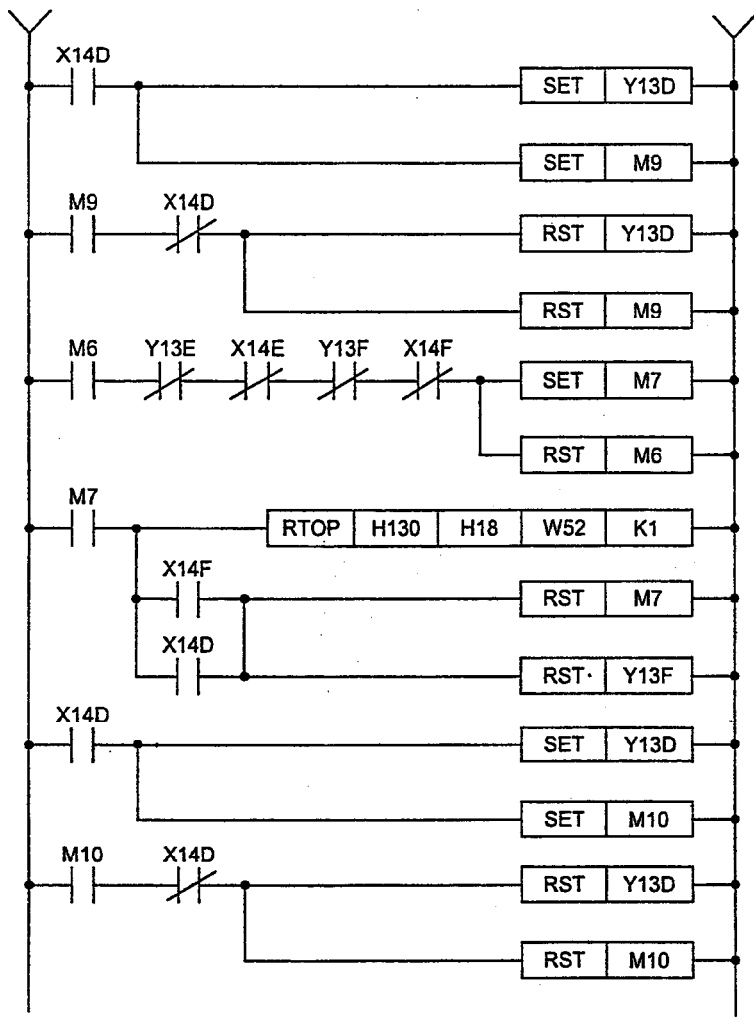

Interlock conditions for executing **RTOP**
(Y13E, X14E, Y13F, X14F)

W52 stores K1 (set data setting request).

Resets the execution command as X14F is switched on when remote station executes **RTOP** instruction.

Resets **RTOP** instruction execution flag.

POINT

Among the link registers (M→R) specified in the link parameter setting, do not use the link registers equivalent to the number of special modules loaded in the remote station.

Example: When W50 to W100 have been specified in the link parameter setting, use W51 to W100 if one special module is loaded in the remote station.

6. TROUBLESHOOTING

6.1 Error Code List

When an error occurs during use of the A616AD and A60MX/A60MXR, the corresponding error code is indicated on the LED display. The error code is a 16-bit binary and is written to the error code area (address 5_H).

Type	Error Code	Description	A616AD Operation	"RUN" LED
Card data error	01	(1) A60MX/A60MXR is faulty or incorrectly loaded. (2) Extension cable is faulty or incorrectly connected.	A/D conversion is not executed.	Off
Multiplex module removed	02	(1) Multiplex module has been removed during A/D conversion. (2) Extension cable has been disconnected during A/D conversion. (3) CNT. NO. switch of the A60MX/A60MXR has been moved after power is switched on.	Processing stops.	Off
CONNECT NO. switch setting error	03	CNT. NO. switch of any multiplex module has been set to a position other than 0 to 7.	Module set to other than 0-7: A/D conversion is not executed. Module set to 0-7: Processing continues.	Off
Buffer memory write disable error	10	Data has been written from the PLC CPU to the buffer memory read-only area. (Addresses 2 _H , 30 to 3F _H , 100 to 17F _H)	Processing continues.	Flicker
Sampling period setting error	11	(1) The value set is outside the range 7 to 30,000ms. (2) The value set is less than 7ms X (number of channels used).	Processing continues with the previous set value.	Flicker
Set data setting request error	12	The value written to the set data setting request area is other than "1".	At initial setting: A/D conversion is not executed. During A/D conversion: Processing continues with the previous set value.	Flicker
Direct access setting error	20	The INPUT or CNT. number set is outside the range 0 to F _H .	Direct access processing stops. Sampling processing continues.	Flicker
	21	The MX CH. number set is outside the range 0 to F _H .		
Buffer memory transfer error	30	The work memory is full because there are too many FROM/TO instructions and the A/D conversion data cannot be written to the buffer memory.	Processing continues.	Flicker
WDT error	**	(1) CPU hardware fault. (2) Buffer memory transfer error continued for longer than the given period of time.	Processing stops.	Off

Table 6.1 Error Code List

POINT

(1) To clear the error code area (address 5_H), write 0 from the PLC CPU. (For details, see Section 5.8.)

(2) The buffer memory data at the occurrence of any error is retained.

6.2 Troubleshooting

Troubleshooting procedures for use of the A616AD are given below. For problems relating to the CPU module, see the corresponding CPU module user's manual.

6.2.1 General troubleshooting

Symptom	Remedy
"RUN" LED flickering	Section 6.2.2
"RUN" LED off	Section 6.2.3
CPU module in "SP. UNIT DOWN"	Section 6.2.4
CPU module in "SP. UNIT ERROR"	Section 6.2.5
CPU module in "CONTROL-BUS ERR."	Section 6.2.6
READY signal (X1) remains off	Section 6.2.7
WDT error signal (X0) on	Section 6.2.8
Error code in special register D9008	Section 6.2.9
Digital value unreadable from CPU.	Section 6.2.10
Analog and digital value mismatch	Section 6.2.11
Digital value "−2048" or "−48" only read to CPU module or A616AD LED display if different analog values are entered.	Section 6.2.11
Digital value "2047" or "4047" only read to CPU module or A616AD LED display if different analog values are entered.	Section 6.2.11
Sudden digital value change	Section 6.2.12
Constant digital value deviation from reference value	Section 6.2.13
Error code indicated on LED display	Section 6.2.14

6.2.2 "RUN" LED flickering

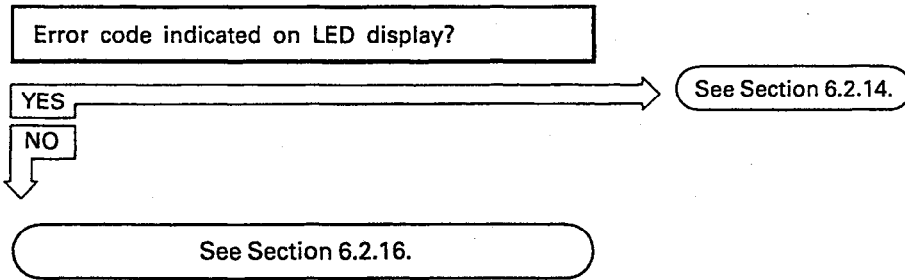

6.2.3 "RUN" LED off

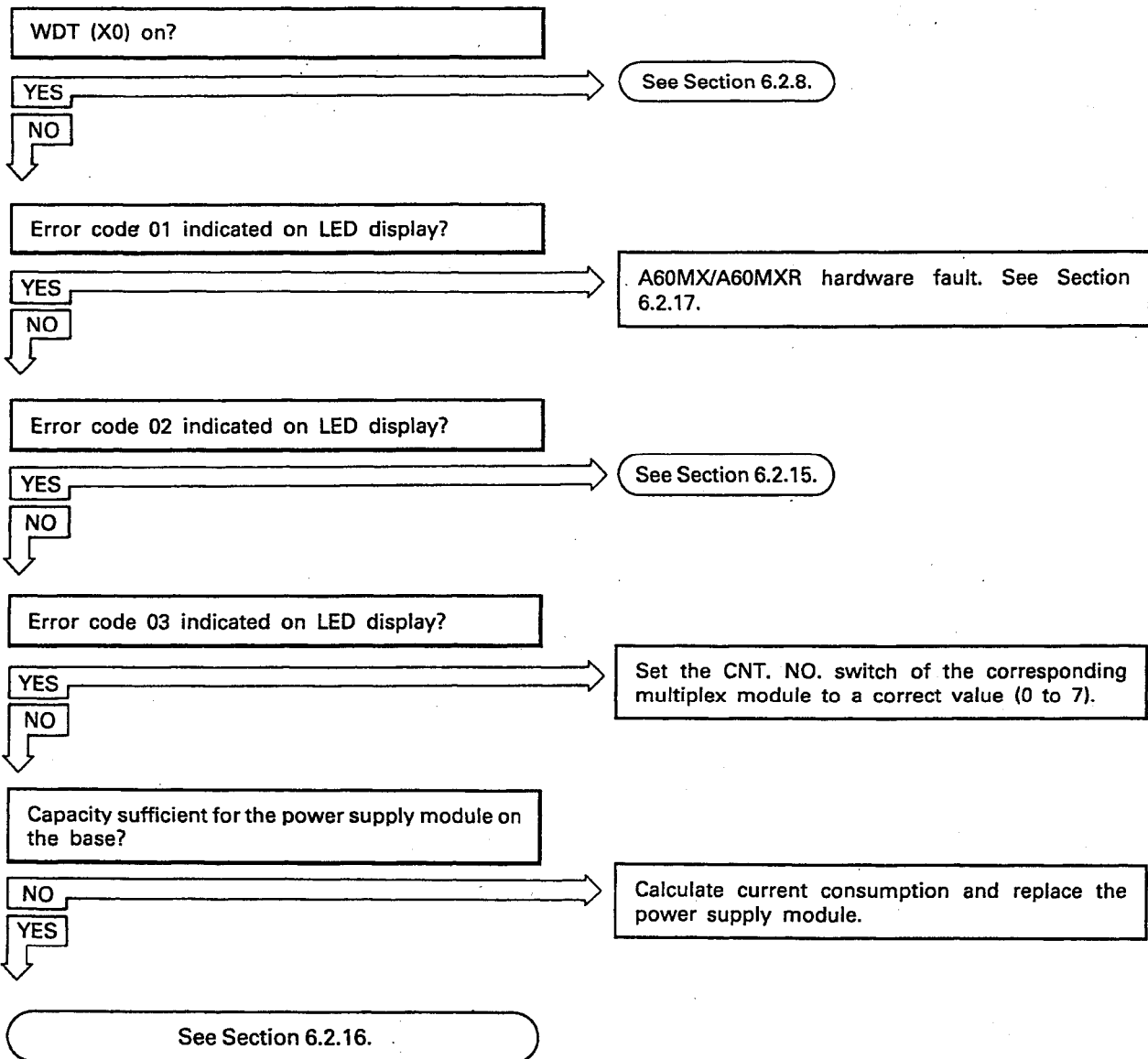

6.2.4 CPU module in "SP. UNIT DOWN" error

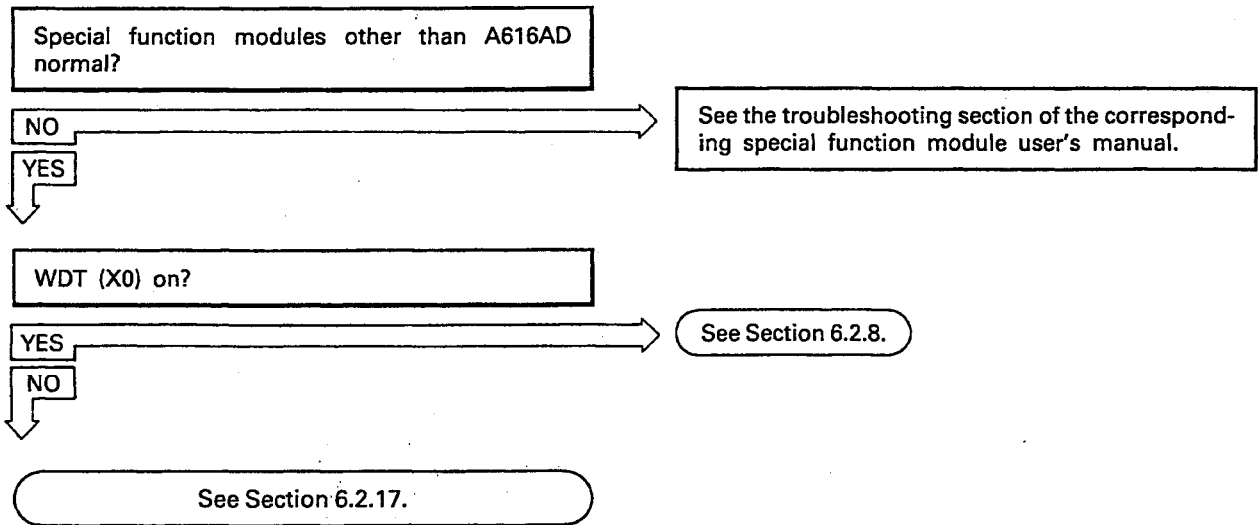

6.2.5 CPU module in "SP. UNIT ERROR"

Read the faulty step of the sequence program by the peripheral device. Check and correct the FROM / TO instruction at the faulty step.

6.2.6 CPU module in "CONTROL-BUS ERR."

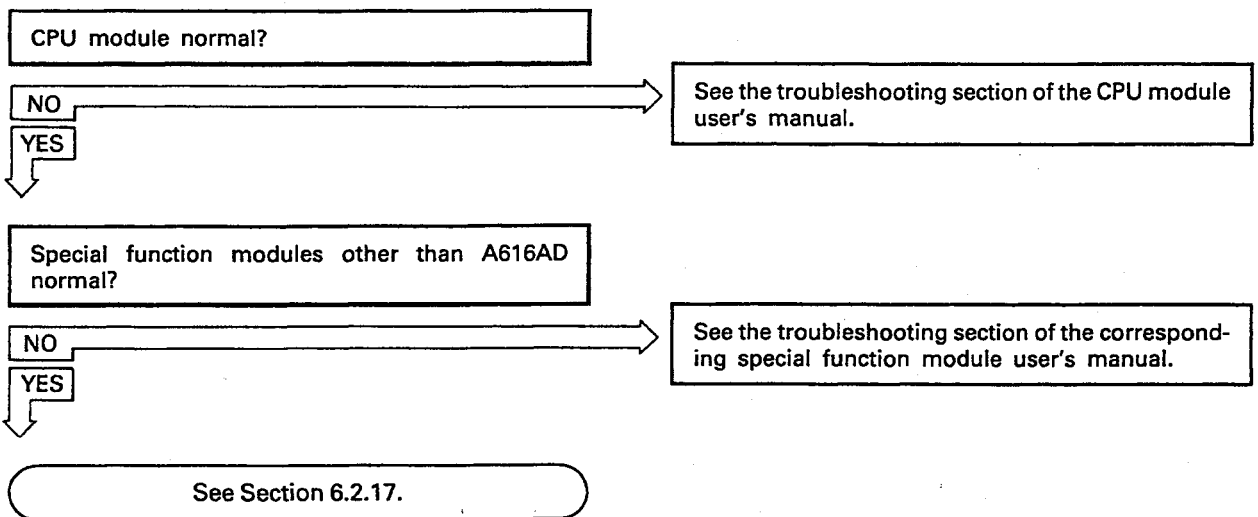

6.2.7 READY signal (X1) remains off

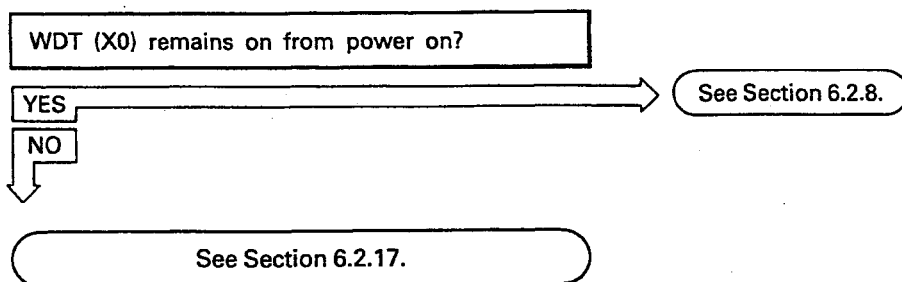

6.2.8 WDT error signal (X0) on

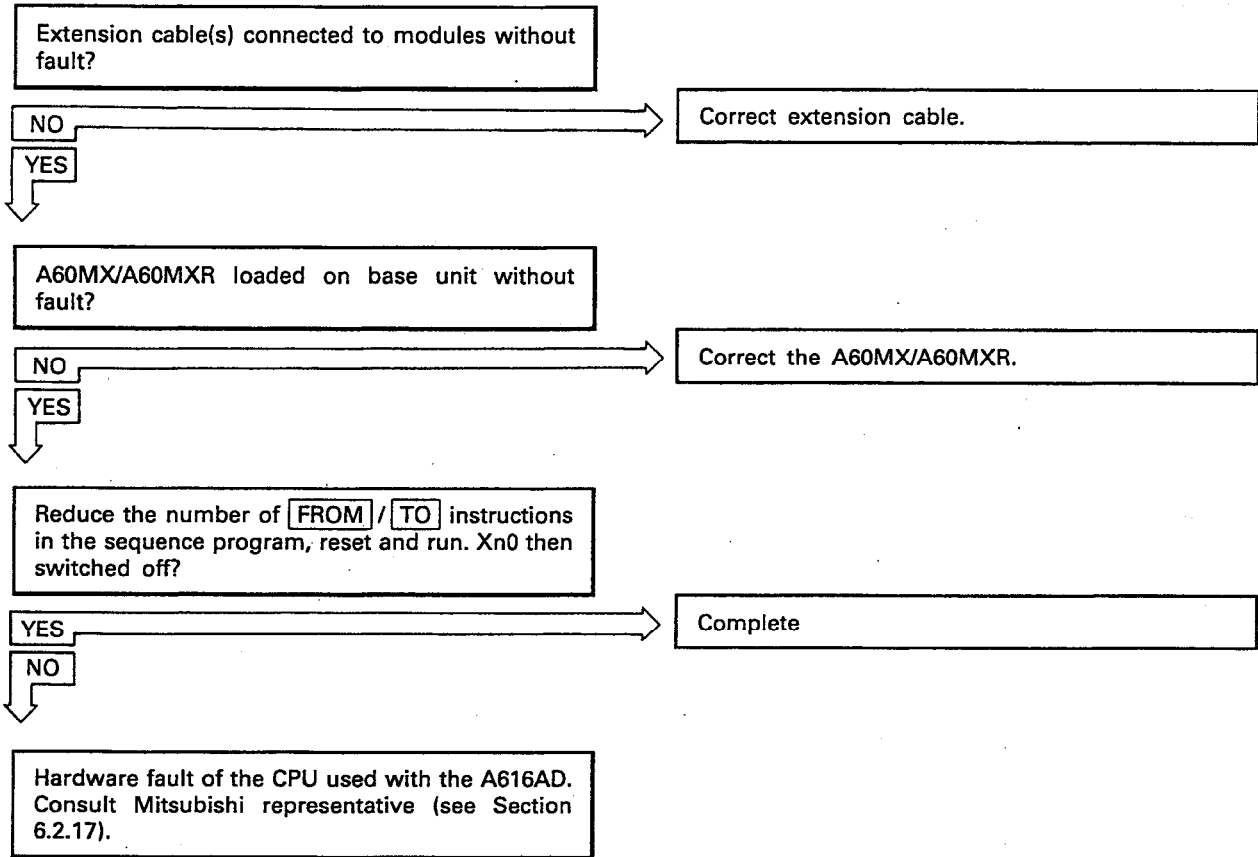

6.2.9 Error code in special register D9008

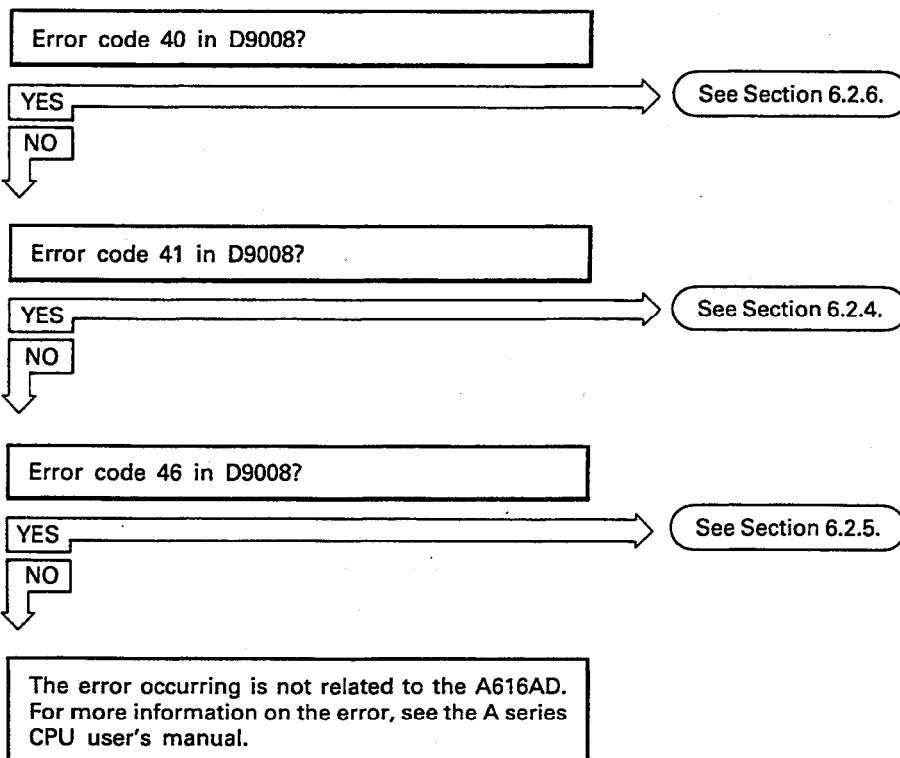

6.2.10 Digital value unreadable from CPU

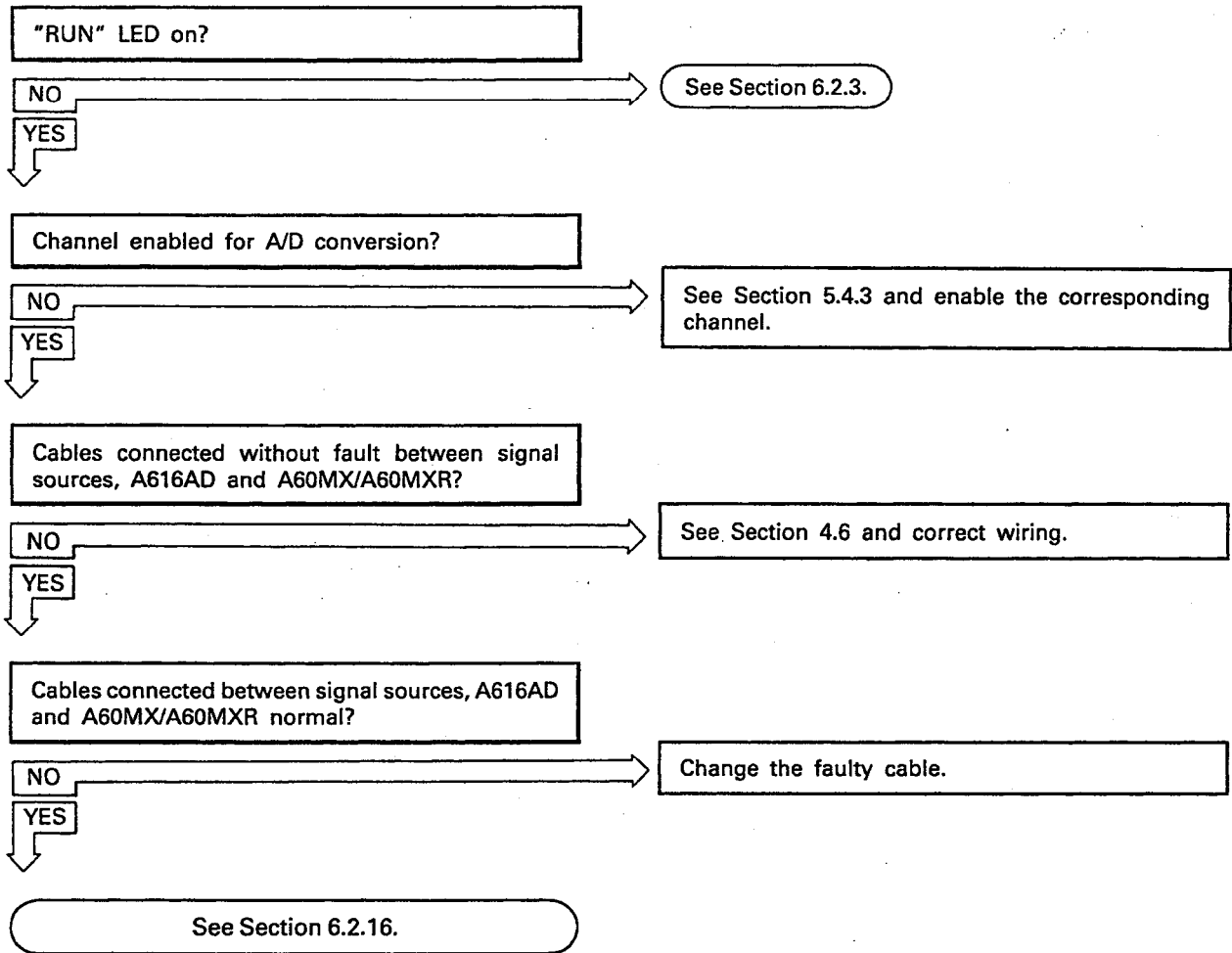

6.2.11 Analog and digital value mismatch

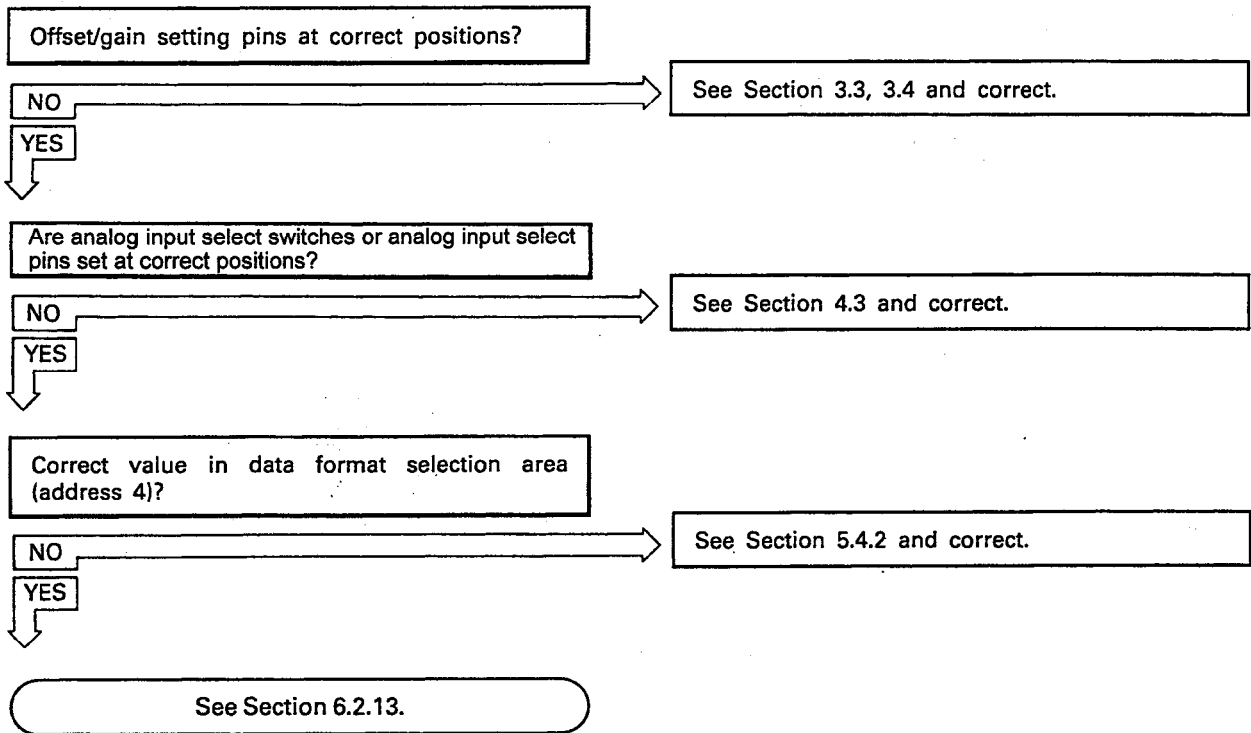

6.2.12 Sudden digital value change

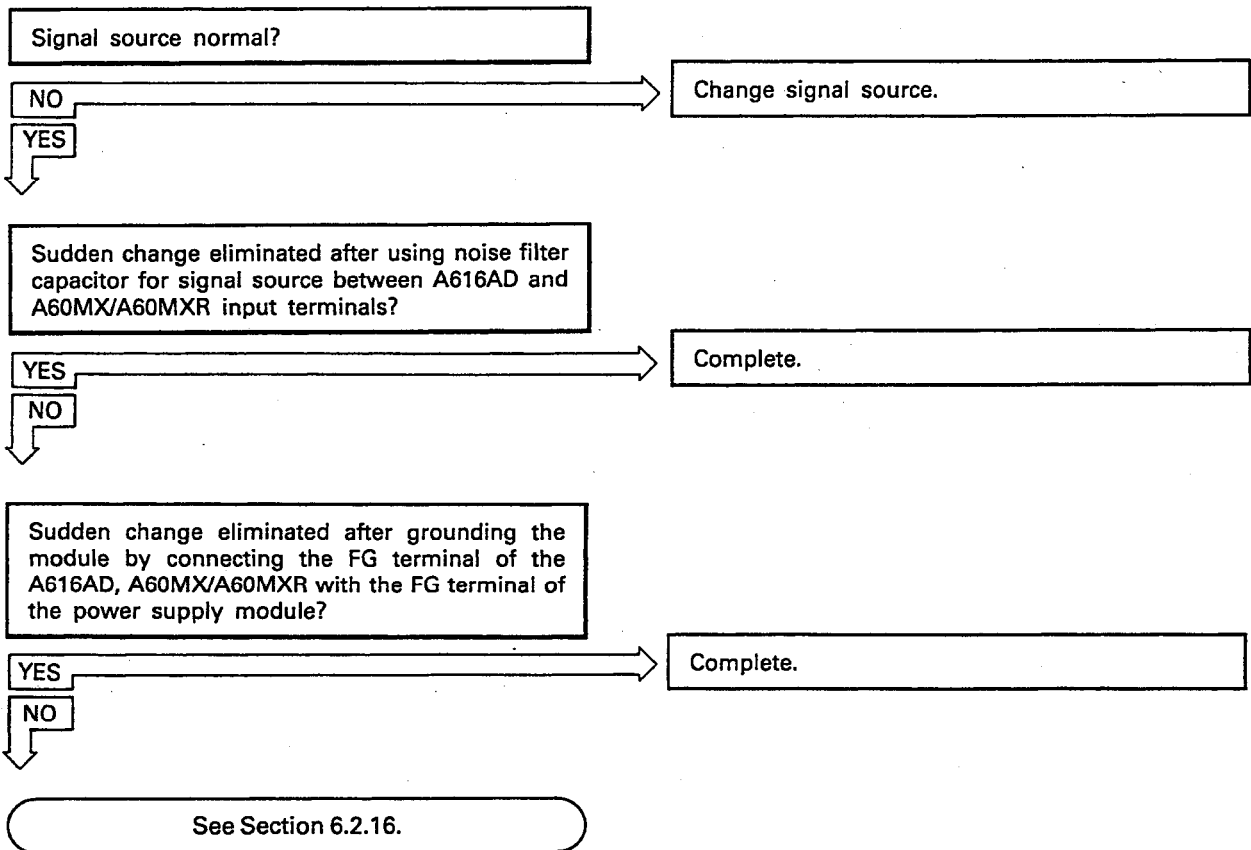

6.2.13 Constant digital value deviation from reference value

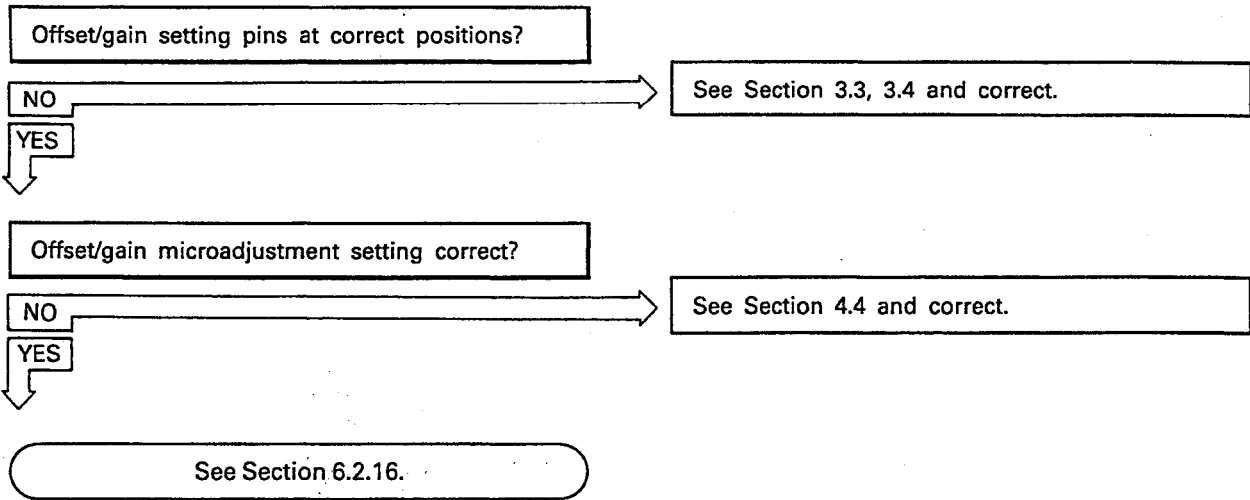

6.2.14 Error code indicated on LED display

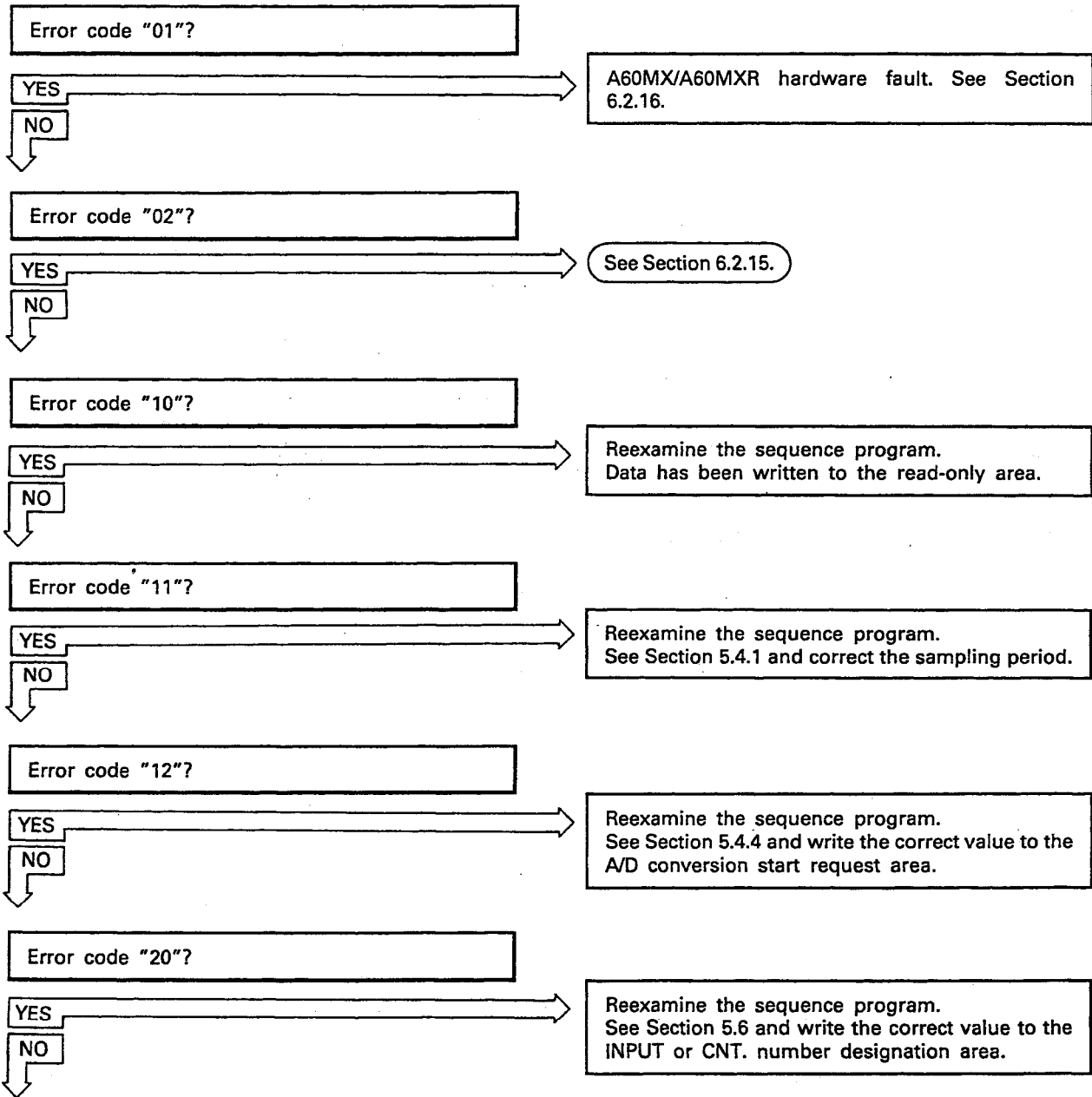

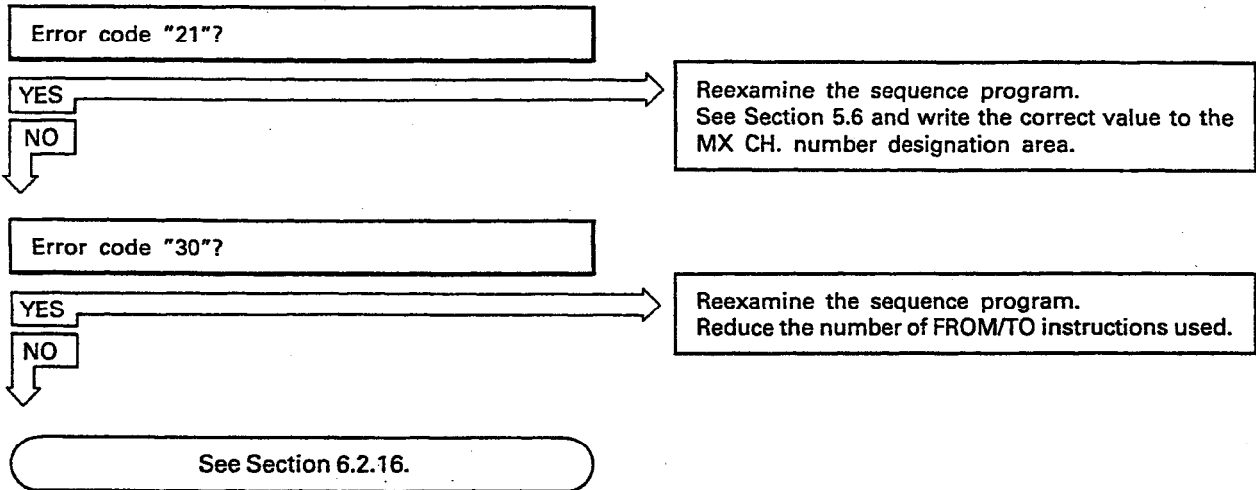

6.2.15 Error code "02" indicated on LED display

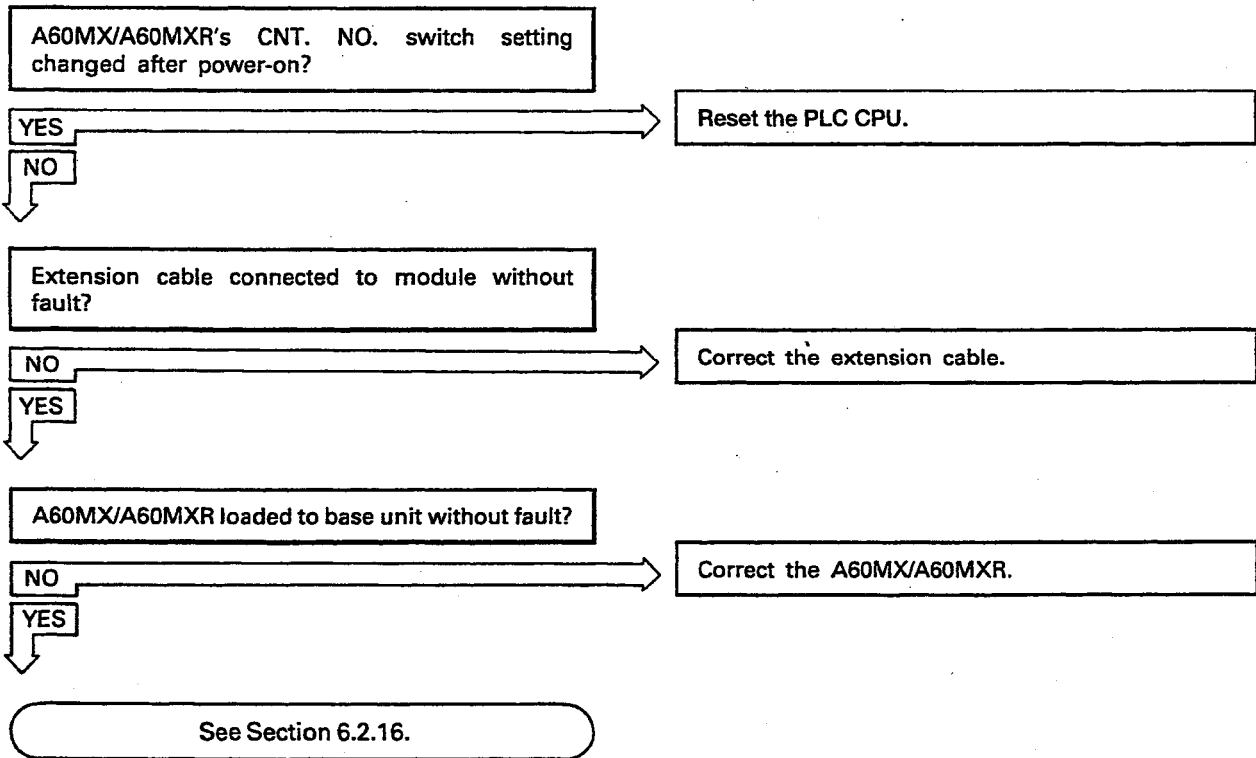

6.2.16 Checking A616AD, A60MX/A60MXR hardware fault

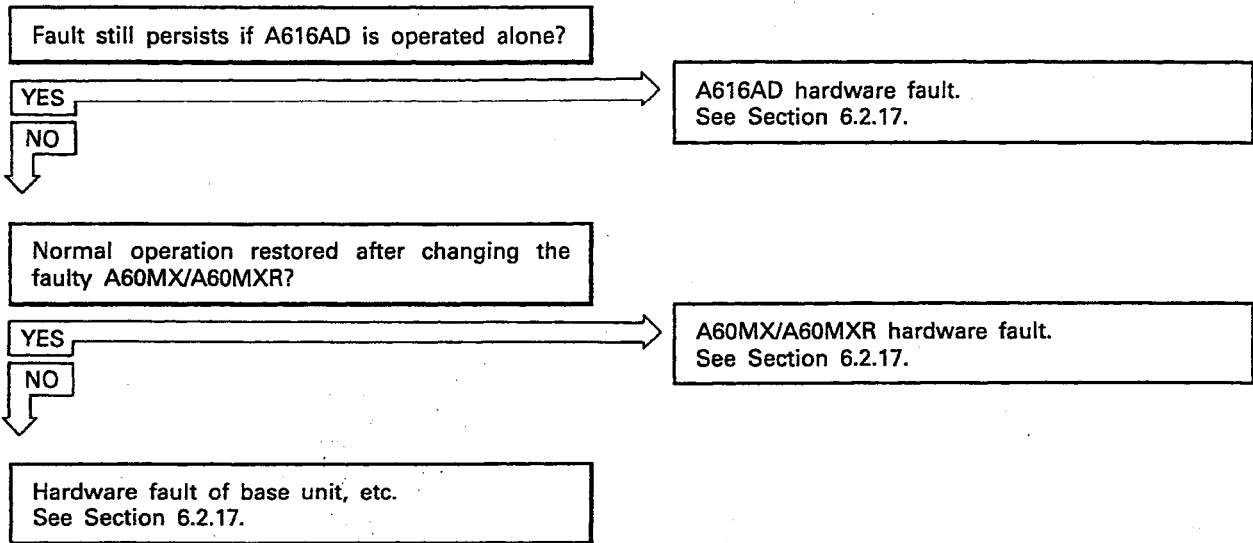

6.2.17 A616AD, A60MX/A60MXR hardware fault

Please return the faulty module to Mitsubishi representative with fault details.

APPENDICES

Appendix 1 Precautions for Replacing A60MXR with A60MXRN

The following are the precautions for replacing the A60MXR with the A60MXRN.

- (1) The inter-channel dielectric withstand voltage of the A60MXR is 500VDC (accuracy guarantee 500VDC) while that of the A60MXRN is 400VDC (accuracy guarantee 400VDC).
- (2) Since the A60MXRN is provided with the setting pins (the A60MXR is provided with the DIP switches) for analog input selection, the setting method differs between the two models.
Refer to Section 4.3.4 for details.
- (3) Programs created for the A60MXR can be used unchanged for the A60MXRN.

Appendix 2 A616AD Dimensions

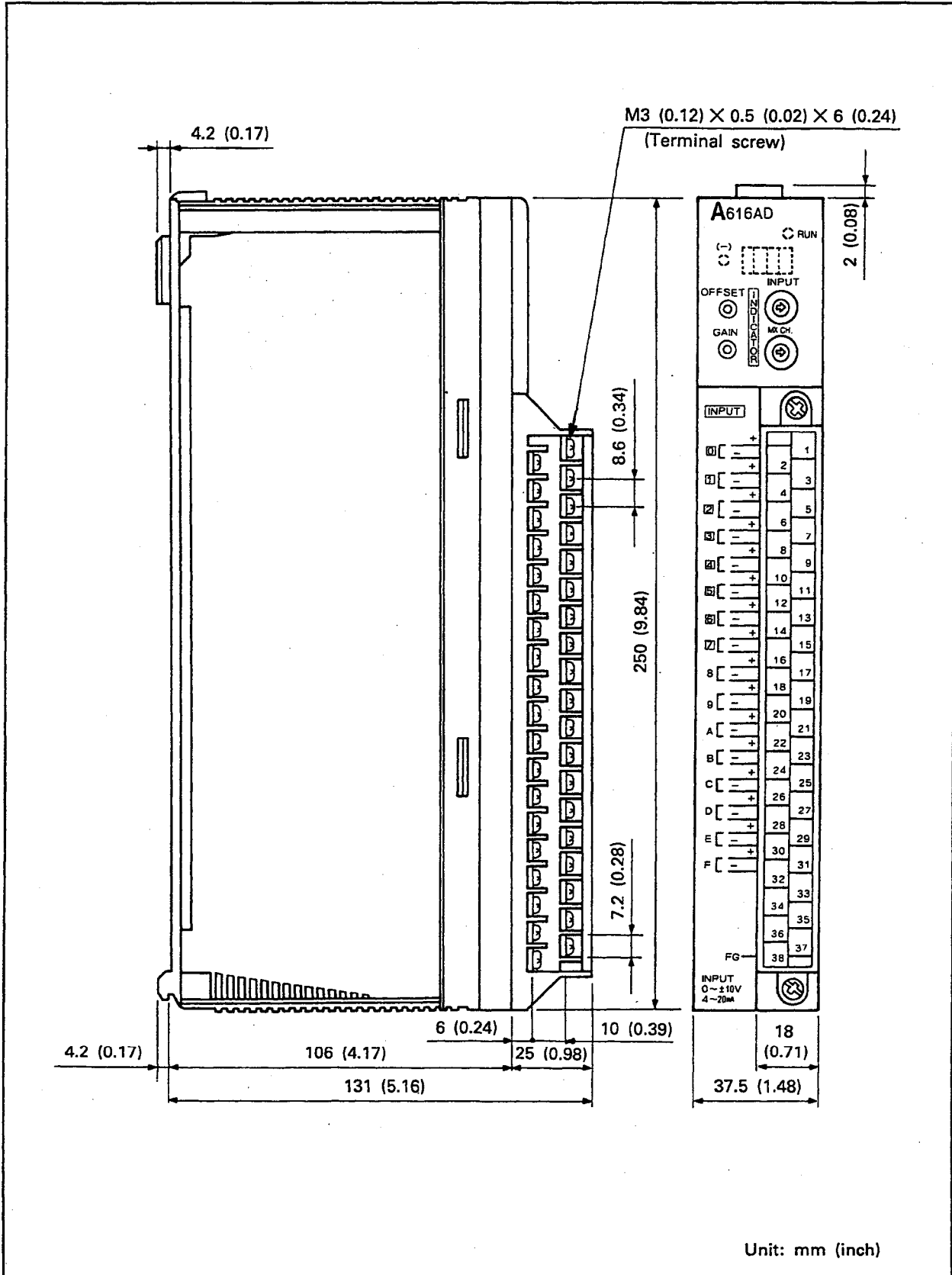

Appendix 3 A60MX/A60MXR Dimensions

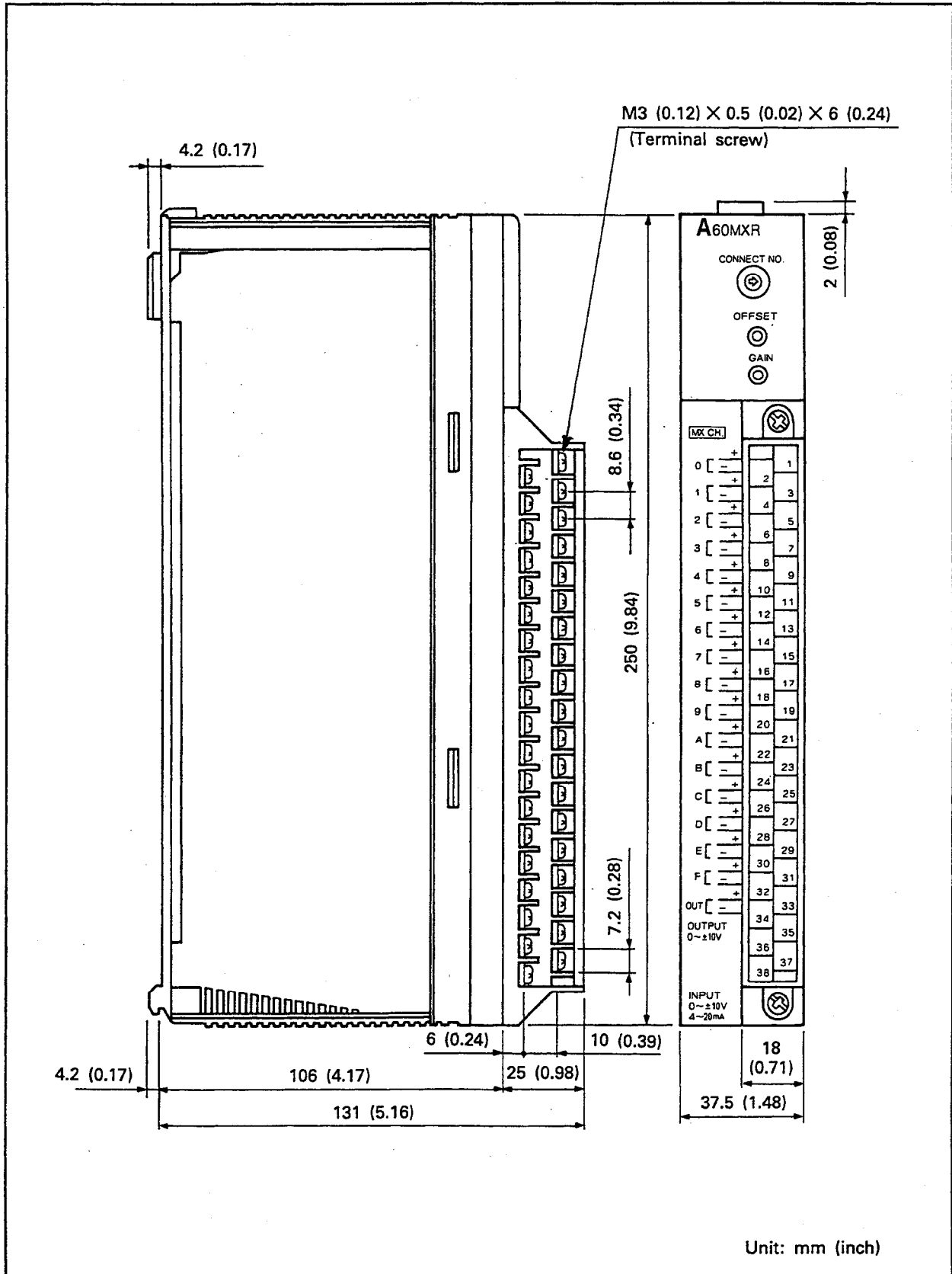

WARRANTY

Please confirm the following product warranty details before using this product.

1. Gratis Warranty Term and Gratis Warranty Range

If any faults or defects (hereinafter "Failure") found to be the responsibility of Mitsubishi occurs during use of the product within the gratis warranty term, the product shall be repaired at no cost via the sales representative or Mitsubishi Service Company.

However, if repairs are required onsite at domestic or overseas location, expenses to send an engineer will be solely at the customer's discretion. Mitsubishi shall not be held responsible for any re-commissioning, maintenance, or testing on-site that involves replacement of the failed module.

[Gratis Warranty Term]

The gratis warranty term of the product shall be for one year after the date of purchase or delivery to a designated place.

Note that after manufacture and shipment from Mitsubishi, the maximum distribution period shall be six (6) months, and the longest gratis warranty term after manufacturing shall be eighteen (18) months. The gratis warranty term of repair parts shall not exceed the gratis warranty term before repairs.

[Gratis Warranty Range]

- (1) The range shall be limited to normal use within the usage state, usage methods and usage environment, etc., which follow the conditions and precautions, etc., given in the instruction manual, user's manual and caution labels on the product.
- (2) Even within the gratis warranty term, repairs shall be charged for in the following cases.
 1. Failure occurring from inappropriate storage or handling, carelessness or negligence by the user. Failure caused by the user's hardware or software design.
 2. Failure caused by unapproved modifications, etc., to the product by the user.
 3. When the Mitsubishi product is assembled into a user's device, Failure that could have been avoided if functions or structures, judged as necessary in the legal safety measures the user's device is subject to or as necessary by industry standards, had been provided.
 4. Failure that could have been avoided if consumable parts (battery, backlight, fuse, etc.) designated in the instruction manual had been correctly serviced or replaced.
 5. Failure caused by external irresistible forces such as fires or abnormal voltages, and Failure caused by force majeure such as earthquakes, lightning, wind and water damage.
 6. Failure caused by reasons unpredictable by scientific technology standards at time of shipment from Mitsubishi.
 7. Any other failure found not to be the responsibility of Mitsubishi or that admitted not to be so by the user.

2. Onerous repair term after discontinuation of production

- (1) Mitsubishi shall accept onerous product repairs for seven (7) years after production of the product is discontinued. Discontinuation of production shall be notified with Mitsubishi Technical Bulletins, etc.
- (2) Product supply (including repair parts) is not available after production is discontinued.

3. Overseas service

Overseas, repairs shall be accepted by Mitsubishi's local overseas FA Center. Note that the repair conditions at each FA Center may differ.

4. Exclusion of loss in opportunity and secondary loss from warranty liability

Regardless of the gratis warranty term, Mitsubishi shall not be liable for compensation of damages caused by any cause found not to be the responsibility of Mitsubishi, loss in opportunity, lost profits incurred to the user by Failures of Mitsubishi products, special damages and secondary damages whether foreseeable or not, compensation for accidents, and compensation for damages to products other than Mitsubishi products, replacement by the user, maintenance of on-site equipment, start-up test run and other tasks.

5. Changes in product specifications

The specifications given in the catalogs, manuals or technical documents are subject to change without prior notice.

6. Product application

- (1) In using the Mitsubishi MELSEC programmable logic controller, the usage conditions shall be that the application will not lead to a major accident even if any problem or fault should occur in the programmable logic controller device, and that backup and fail-safe functions are systematically provided outside of the device for any problem or fault.
- (2) The Mitsubishi programmable logic controller has been designed and manufactured for applications in general industries, etc. Thus, applications in which the public could be affected such as in nuclear power plants and other power plants operated by respective power companies, and applications in which a special quality assurance system is required, such as for Railway companies or Public service purposes shall be excluded from the programmable logic controller applications.

In addition, applications in which human life or property that could be greatly affected, such as in aircraft, medical applications, incineration and fuel devices, manned transportation, equipment for recreation and amusement, and safety devices, shall also be excluded from the programmable logic controller range of applications.

However, in certain cases, some applications may be possible, providing the user consults their local Mitsubishi representative outlining the special requirements of the project, and providing that all parties concerned agree to the special circumstances, solely at the users discretion.

Analog-Digital Converter Module Type A616AD

User's Manual

MODEL	A616AD-USERS-E
MODEL CODE	13J645
IB(NA)-66171-E(0411)MEE	

 **MITSUBISHI ELECTRIC CORPORATION**

HEAD OFFICE : 1-8-12, OFFICE TOWER Z 14F HARUMI CHUO-KU 104-6212, JAPAN
NAGOYA WORKS : 1-14, YADA-MINAMI 5-CHOME, HIGASHI-KU, NAGOYA, JAPAN

When exported from Japan, this manual does not require application to the Ministry of Economy, Trade and Industry for service transaction permission.

Specifications subject to change without notice.