

MITSUBISHI

GT SoftGOT Version5

Operating Manual

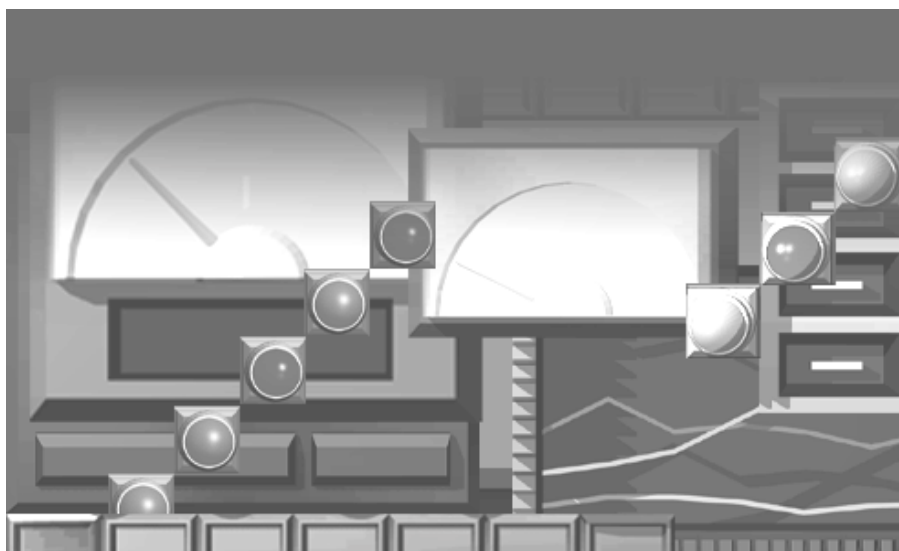

Graphic Operation Terminal
900
series



MELSOFT
Integrated Software

SW5D5C-GTWORKS-E

MITSUBISHI Graphic Operation Terminal

• SAFETY PRECAUTIONS •

(Always read these instructions before using this equipment.)

Before using this product, please read this manual and the relevant manuals introduced in this manual carefully and pay full attention to safety to handle the product correctly.

The instructions given in this manual are concerned with this product. For the safety instructions of the programmable controller system, please read the CPU module user's manual.

In this manual, the safety instructions are ranked as "DANGER" and "CAUTION".



Indicates that incorrect handling may cause hazardous conditions, resulting in death or severe injury.



Indicates that incorrect handling may cause hazardous conditions, resulting in medium or slight personal injury or physical damage.

Note that the  CAUTION level may lead to a serious consequence according to the circumstances. Always follow the instructions of both levels because they are important to personal safety.

Please save this manual to make it accessible when required and always forward it to the end user.

[Test Operation Instructions]

DANGER

- Before performing test operation (bit device on/off, word device's present value changing, timer/counter's set value and present value changing, buffer memory's present value changing) for a user-created monitor screen, system monitoring, special module monitoring or ladder monitoring, read the manual carefully to fully understand how to operate the equipment. During test operation, never change the data of the devices which are used to perform significant operation for the system. False output or malfunction can cause an accident.

Precautions for using this software (important)

1. Memory of the personal computer used

Processing may be terminated by Windows[®] on some personal computer models having main memory of not more than 64M bytes. Therefore, use them after increasing the main memory to 64M bytes or more.

2. Free space on the hard disk

While this software is running, free space of at least 50M byte is required on the hard disk.

Since free space of 50M byte is required by Windows[®] as the swap area, Windows[®] may forcibly terminate the program if that free space is used up while the this software is running. Produce a sufficient amount of free space on the hard disk before using the this software.

3. Instructions for displaying any line other than a continuous line (such as a dotted line) in boldface type

When any line other than a continuous line is drawn in boldface type, the personal computer screen may not display the line type properly. However, it is displayed properly on the GOT and there are no problems in data.

REVISIONS

* The manual number is given on the bottom left of the back cover.

Print Date	* Manual Number	Revision
Feb., 2001	SH (NA)-080156-A	First edition
May, 2001	SH (NA)-080156-B	<p>Partial corrections Section 2.3.1, Section 2.3.2, Section 5.3.1</p> <p>Partial additions Section 5.3.3</p>
Jun., 2001	SH (NA)-080156-C	<p>Partial corrections Section 2.1.1, Section 2.1.2, Section 2.2, Section 2.3.1, Section 2.3.2, Section 2.4.1, Section 3.1, Section 3.2, Section 3.3.2, Section 5.1, Section 5.3.1, Section 5.3.2, Section 5.3.3</p> <p>Partial additions Section 5.2, Section 7.1</p> <p>Additions Section 2.5.3, Appendix 1</p>
Aug., 2001	SH (NA)-080156-D	<p>Partial corrections Section 5.1, Section 5.6, Section 5.7, Section 5.8, Section 5.9, Section 5.11</p> <p>Partial additions Section 2.1, Section 2.2, Section 2.3, Section 2.4, Section 2.5, Section 3.1, Section 3.2, Section 4.1, Section 4.2, Section 5.5, Appendix 1</p> <p>Additions Section 5.4, Section 6.5</p>
May, 2002	SH (NA)-080156-E	<p>Partial corrections Section 2.1.2, Section 3.1, Section 3.2, Section 5.5, Section 5.6, Section 5.7, Section 5.9, Section 6.4.4</p> <p>Partial additions Section 2.3.1, Section 2.3.2, Section 4.2, Section 5.3, Section 5.10, Section 5.11, Section 6.3, Section 6.4.3, Section 6.4.5, Section 6.5, Section 7.3, Appendix 1</p> <p>Additions Section 6.6, Section 6.7</p>
Oct., 2002	SH (NA)-080156-F	<p>Partial corrections Section 2.5.3, Section 5.3.1, Section 5.3.2, Section 5.3.3, Section 5.5, Section 5.5.1</p> <p>Partial additions Section 2.2, Section 3.2, Section 3.3.2, Appendix 1</p> <p>Additions Section 2.3.4, Section 2.4.4, Section 2.5.4</p>
Jun., 2004	SH (NA)-080156-G	<p>Partial corrections Manuals</p> <p>MODEL CODE change Changed from 13JU12 to 1DM193</p>

Japanese Manual Version SH-080131-I

This manual confers no industrial property rights or any rights of any other kind, nor does it confer any patent licenses. Mitsubishi Electric Corporation cannot be held responsible for any problems involving industrial property rights which may occur as a result of using the contents noted in this manual.

© 2001 MITSUBISHI ELECTRIC CORPORATION

INTRODUCTION

Thank you for choosing the Mitsubishi Graphic Operation Terminal.
Before using the equipment, please read this manual carefully to use the equipment to its optimum.

CONTENTS

About manuals	A- 7
Abbreviations and generic terms in this manual	A- 8

1. OVERVIEW	1- 1 to 1- 2
--------------------	---------------------

1.1 Features	1- 1
--------------------	------

2. SYSTEM CONFIGURATION	2- 1 to 2-15
--------------------------------	---------------------

2.1 System Configuration at Installation of GT SoftGOT	2- 1
2.1.1 System configuration	2- 1
2.1.2 Operation environment	2- 1
2.2 System Configuration for GT SoftGOT Execution	2- 2
2.3 Equipment that can Be Used Together with GT SoftGOT	2- 4
2.3.1 PLC CPUs that can be connected	2- 4
2.3.2 Ethernet units and Ethernet boards/cards that can be used	2- 5
2.3.3 Computer link units and serial communication units that can be used	2- 5
2.3.4 Network units and network boards that can be connected	2- 6
2.4 About the cable	2- 7
2.4.1 Cables used for connecting directly to CPUs	2- 7
2.4.2 Cables used for connecting via Ethernet	2- 7
2.4.3 Cable used for connecting Computer link connection	2- 8
2.4.4 Cables used for connecting MELSECNET connection	2-12
2.5 Access range for monitoring	2-13
2.5.1 Access range that can be monitored when CPU direct connection/computer link connection	2-13
2.5.2 Access range that can be monitored when connecting via Ethernet	2-13
2.5.3 Access range that can be monitored for Q bus connection (only when PC CPU module is used)	2-14
2.5.4 Access ranges that can be monitored for MELSECNET connection	2-15

3. SPECIFICATIONS	3- 1 to 3- 5
--------------------------	---------------------

3.1 Specifications of the GT SoftGOT	3- 1
3.2 Functions that cannot be Used	3- 2
3.3 Restrictions on and Instructions for use of GT SoftGOT	3- 4
3.3.1 Restrictions on and instructions for GT SoftGOT	3- 4
3.3.2 Restrictions on and instructions for PLC CPU connection	3- 5

4. SCREEN CONFIGURATION OF GT SOFTGOT	4- 1 to 4- 4
--	---------------------

4.1 Screen Configuration and Various Tools of GT SoftGOT	4- 1
4.2 Menu Configuration	4- 3

5. GT SOFTGOT OPERATING METHOD	5- 1 to 5-29
--------------------------------	--------------

5.1 General Procedure for Monitoring with GT SoftGOT	5- 1
5.2 How to Use the License Key/License Key FD	5- 2
5.3 How to set up Ethernet connection	5- 6
5.3.1 When using E71	5- 6
5.3.2 When using QE71	5-11
5.3.3 When using Q Series Compatible E71	5-14
5.3.4 How to Set Devices Using GT Designer	5-17
5.4 How to set up the Computer link connection	5-18
5.4.1 When using A Series	5-18
5.4.2 When using QnA Series	5-19
5.4.3 When using Q Series	5-20
5.4.4 Transmission specifications	5-20
5.5 Option Setting.....	5-21
5.5.1 Option Setting Dialog Box	5-22
5.6 Execution of monitor	5-24
5.7 Opening the Project	5-25
5.7.1 Description of the monitor data reading dialog box	5-27
5.8 Operation at Monitoring	5-28
5.9 Stopping Monitoring	5-28
5.10 Exiting from GT SoftGOT.....	5-28
5.11 Automatic Startup.....	5-29

6. FUNCTIONS OF GT SOFTGOT	6- 1 to 6-20
----------------------------	--------------

6.1 Snap Shot Function	6- 1
6.1.1 Operating procedure	6- 1
6.2 Print Function	6- 2
6.2.1 Operating procedure	6- 2
6.2.2 Print preview	6- 2
6.2.3 Page setup	6- 2
6.3 Data Reference Function	6- 3
6.4 Mail Function	6- 4
6.4.1 Mail function overview.....	6- 4
6.4.2 Operation flow when using the mail function.....	6- 5
6.4.3 How to set up the mail function.....	6- 6
6.4.4 Sending e-mail.....	6-11
6.4.5 Mail history	6-13
6.5 Keyboard input function	6-14
6.5.1 Keyboard Input Enabling/Disabling Procedure.....	6-14
6.5.2 When operating the numerical input function or the ASCII input function from the keyboard of a PC	6-14
6.5.3 How to Use the Function Keys	6-15
6.5.4 Precautions for Use.....	6-15

6.6 Full Screen Mode Function.....	6-16
6.6.1 Full screen mode function types.....	6-16
6.6.2 Setting method.....	6-18
6.6.3 Precautions for use	6-19
6.7 Disable/Enable of Popumenu	6-20
6.7.1 Setting method.....	6-20
6.7.2 Precautions for use	6-20

7. TROUBLESHOOTING	7- 1 to 7- 4
--------------------	--------------

7.1 Error messages.....	7- 1
7.2 Troubleshooting Related to the License Key	7- 3
7.3 Troubleshooting Related to Mail Transmission.....	7- 4

APPENDIX	App- 1 to App- 3
----------	------------------

Appendix1 List of Functions Added to Update GT SoftGOT	App- 1
--	--------

INDEX	Index- 1 to Index- 2
-------	----------------------

Manuals

The following manuals are relevant to this product.
Refer to the following list and order the required manuals.

- Detailed manual

Manual name	Manual number (Model code)
A985GOT/A975GOT/A970GOT/A960GOT User's Manual Explains the specifications, general system configuration, component devices, part names, option unit loading methods, installation and wiring methods, maintenance and inspection methods, and error codes of A985GOT/A975GOT/A970GOT/A960GOT unit. (Available as option)	SH-4005 (1DM099)
A950GOT/A951GOT/A953GOT/A956GOT User's Manual Explains the specifications, general system configuration, component devices, part names, option unit loading methods, installation and wiring methods, maintenance and inspection methods, and error codes of A950GOT/A951GOT/A953GOT/A956GOT unit. (Available as option)	SH-080018 (1DM103)

- Relevant Manual

For relevant manual, refer to the PDF manual stored within the drawing software.

Abbreviations and generic terms in this manual

Abbreviations, generic terms and special terms used in this manual are described as follows:

Abbreviations, generic terms and special terms	Description	
GOT	A985GOT-V	Generic term of A985GOT-TBA-V and A985GOT-TBD-V
	A985GOT	Generic term of A985GOT-TBA, A985GOT-TBD and A985GOT-TBA-EU
	A975GOT	Generic term of A975GOT-TBA-B, A975GOT-TBD-B, A975GOT-TBA, A975GOT-TBD and A975GOT-TBA-EU
	A970GOT	Generic term of A970GOT-TBA-B A970GOT-TBD-B, A970GOT-TBA, A970GOT-TBD, A970GOT-SBA, A970GOT-SBD, A970GOT-LBA, A970GOT-LBD, A970GOT-TBA-EU and A970GOT-SBA-EU
	A97*GOT	Generic term of A975GOT and A970GOT
	A960GOT	Generic term of A960GOT-EBA, A960GOT-EBD and A960GOT-EBA-EU
	A956WGOT	Abbreviation of A956WGOT-TBD
	A956GOT	Generic term of A956GOT-TBD, A956GOT-SBD, A956GOT-LBD, A956GOT-TBD-M3, A956GOT-SBD-M3 and A956GOT-LBD-M3
	A953GOT	Generic term of A953GOT-TBD, A953GOT-SBD, A953GOT-LBD, A953GOT-TBD-M3, A953GOT-SBD-M3 and A953GOT-LBD-M3
	A951GOT	Generic term of A951GOT-TBD, A951GOT-SBD, A951GOT-LBD, A951GOT-TBD-M3, A951GOT-SBD-M3 and A951GOT-LBD-M3
	A951GOT-Q	Generic term of A951GOT-QTBD, A951GOT-QSBD, A951GOT-QLBD, A951GOT-QTBD-M3, A951GOT-QSBD-M3 and A951GOT-QLBD-M3
	A950GOT	Generic term of A950GOT-TBD, A950GOT-SBD, A950GOT-LBD, A950GOT-TBD-M3, A950GOT-SBD-M3 and A950GOT-LBD-M3
	A950 handy GOT	Generic term of A953GOT-SBD-M3-H and A953GOT-LBD-M3-H
	A95*GOT	Generic term of A956GOT, A953GOT, A951GOT, A951GOT-Q, A950GOT and A950 handy GOT
	F940GOT	Generic term of F940GOT-SWD-E, F940GOT-LWD-E, ET-940BH(-L) and ET-940PH(-L)
	F930GOT	Abbreviation of F930GOT-BWD-E
	F940 handy GOT	Generic term of F940GOT-SBD-H, F940GOT-LBD-H, F943GOT-SBD-H, F943GOT-LBD-H, F940GOT-SBD-RH, F940GOT-LBD-RH, F943GOT-SBD-RH and F943GOT-LBD-RH
	F940WGOT	Abbreviation of F940WGOT-TWD
	GOT-A900 series	Generic term of A985GOT-V, A985GOT, A975GOT, A970GOT, A960GOT and A95*GOT
	GOT-F900 series	Generic term of F940GOT, F930GOT, F940 handyGOT and F940WGOT
Software	GT Works Version 5	Abbreviation of SW5D5C-GTWORKS-E software package
	GT Designer Version 5	Generic term of SW5D5C-GOTR-PACKE software package and SW5D5C-GOTR-PACKEV software package
	GT Designer	Abbreviation of image creation software GT Designer for GOT900
	GT Simulator	Abbreviation of GT Simulator screen simulator GOT900
	GT Converter	Abbreviation of data conversion software GT Converter for GOT900
	GT Debugger	Abbreviation of debugging software GT Debugger
	GT Manager	Abbreviation of GT Manager data editing software for GOT900
	GT SoftGOT	Abbreviation of monitoring software GT SoftGOT
GX Developer	Generic term of SW □ D5C-GPPW-E/SW □ D5F-GPPW-E software packages	
CPU	QCPU (Q Mode)	Generic term of Q00JCPU, Q00CPU, Q01CPU, Q02CPU, Q02HCPU, Q06HCPU, Q12HCPU, Q25HCPU, Q12PHCPU and Q25PHCPU CPU units
	QCPU (A Mode)	Generic term of Q02CPU-A, Q02HCPU-A and Q06HCPU-A CPU units
	QCPU	Generic term of QCPU (Q Mode) and QCPU (A Mode)
	QnACPU (Large Type)	Generic term of Q2ACPU, Q2ACPU-S1, Q3ACPU, Q4ACPU and Q4ARCPU CPU units
	QnACPU (Small Type)	Generic term of Q2ASCPU, Q2ASCPU-S1, Q2ASHCPU and Q2ASHCPU-S1 CPU units
	QnACPU	Generic term of QnACPU (Large Type) and QnACPU (Small Type)

Abbreviations, generic terms and special terms		Description
CPU	AnUCPU	Generic term of A2UCPU, A2UCPU-S1, A3UCPU and A4UCPU CPU units
	AnACPU	Generic term of A2ACPU, A2ACPU-S1 and A3ACPU CPU units
	AnNCPUCPU	Generic term of A1NCPUCPU, A2NCPUCPU, A2NCPUCPU-S1 and A3NCPUCPU CPU units
	ACPU (Large Type)	Generic term of AnUCPU, AnACPU and AnNCPUCPU CPU units
	A2US(H)CPU	Generic term of A2USCPU, A2USCPU-S1 and A2USHCPU-S1 CPU units
	AnS(H)CPU	Generic term of A1SCPU, A1SHCPU, A2SCPU and A2SHCPU CPU units
	A1SJ(H)CPU	Generic term of A1SJCPU-S3 and A1SJHCPU CPU units
	ACPU (Small Type)	Generic term of A2US(H)CPU, AnS(H)CPU and A1SJ(H)CPU CPU units
	ACPU	Generic term of ACPUCPU (Large Type), ACPUCPU (Small Type) and A1FXCPU CPU units
	FXCPU	Generic term of FX0 series, FX0N series, FX0S series, FX1 series, FX1N series, FX1NC series, FX1S series, FX2 series, FX2C series, FX2N series, FX2NC series CPU unit
	Motion controller CPU	Generic term of A273UCPU, A273UHCPU, A273UHCPU-S3, A171SCPU-S3, A171SHCPUN, A172SHCPUN, A173UHCPU, A173UHCPU-S1 CPU unit
FA controller	Generic term of LM610, LM7600, LM8000 CPU unit	
Ethernet unit	E71	Generic term of AJ71E71-S3, A1SJ71E71-B2-S3, A1SJ71E71-B5-S3, AJ71E71N-B2, AJ71E71N-B5T, A1SJ71E71-B2 and A1SJ71E71N-B5T
	QE71	Generic term of AJ71QE71, A1SJ71QE71-B2, AJ71QE71-B5, A1SJ71QE71-B5, AJ71QE71N-B2, AJ71QE71N-B5T, A1SJ71QE71-B2 and A1SJ71QE71N-B5T
	Q series-compatible E71	Generic term of QJ71E71, QJ71E71-B2 and QJ71E71-100
Other PLC	Omron PLC	Generic term of C200HS, C200H, C200H α Series (C200HX, C200HG, C200HE), CQM1, C1000H, C2000H, CV500, CV1000, CV2000, CVM1-CPU11, CVM1-CPU21, CS1, CJ1 CPU unit
	Yasukawa PLC	Generic term of GL60S, GL60H, GL70H, GL120, GL130, CP-9200SH, CP-9300MS, MP-920, MP-930, MP-940, CP-9200(H) and PROGIC-8 CPU unit
	SLC500 Series	Generic term of SLC500-20, SLC500-30, SLC500-40, SLC5/01 SLC5/02, SLC5/03, SLC5/04 SLC5/05
	MicroLogix1000 Series	Generic term of 1761-L10BWA, 1761-L10BWB, 1761-L16AWA, 1761-L16BWA, 1761-L16BWB, 1761-L16BBB, 1761-L32AWA, 1761-L32BWA, 1761-L32BWB, 1761-L32BBB, 1761-L32AAA, 1761-L20AWA-5A, 1761-L20BWA-5A, 1761-L20BWB-5A
	MicroLogix1500 Series	Abbreviation of 1764-LSP
	Allen-Bradley PLC	Generic term of SLC 500 Series, MicroLogix1000 Series, MicroLogix1500 Series
	Sharp PLC	Generic term of JW-21CU, JW-22CU, JW-31CUH, JW-32CUH, JW-33CUH, JW-50CUH, JW-70CUH, JW-100CUH CPU unit
	PROSEC T Series	Generic term of T2(PU224type), T2E, T2N, T3, T3H CPU unit
	PROSEC V Series	Abbreviation of Model3000(S3) CPU unit
	Toshiba PLC	Generic term of PROSEC T Series and PROSEC V Series
	SIEMENS PLC	Generic term of SIMATIC S7-300 Series and SIMATIC S7-400 Series CPU unit
	Large type H series	Generic term of H-302(CPU2-03H), H-702(CPU2-07H), H-1002(CPU2-10H), H-2002(CPU2-20H), H-4010(CPU3-40H), J-300(CPU-03Ha), H-700(CPU-07Ha), H-2000(CPU-20Ha)
	H200 to 252 Series	Generic term of H-200(CPU-02H, CPE-02H), H-250(CPU21-02H), H-252(CPU22-02H), H-252B(CPU22-02HB), H-252C(CPU22-02HC, CPE22-02HC)
	H Series board type	Generic term of H-20DR, H-28DR, H-40DR, H-64DR, H-20DT, H-28DT, H-40DT, H-64DT, HL-40DR, HL-64DR
	EH-150 Series	Generic term of EH-CPU104, EH-CPU208, EH-CPU308, EH-CPU316
	HITACHI PLC (HIDIC H Series)	Generic term of large type H series, H-200 to 252 Series H Series board type, EH-150 Series
	Matsushita PLC	Abbreviation of FP Series
	Matsushita Electric Works PLC	Generic term of FP0-C16CT, FP0-C32CT, FP1-C24C, FP1-C40C, FP2, FP3, FP5, FP10(S), FP10SH, FP-M(C20TC) and FP-M(C32TC)
Others	Memory	abbreviation of memory (flash memory) in the GOT
	OS	Abbreviation of GOT system software
	Object	Setting data for dynamic image
	License key	Abbreviation of A9GTSOFT-LKEY-P license key (for DOS/V personal computer)
	License key FD	Abbreviation of SW5D5F-SGLKEY-E (license registration package for PC CPU module)
	DOS/V personal computer	IBM PC/AT [®] or its compatible DOS/V personal computer
	PC CPU module	Abbreviation for MELSEC-Q series compatible PC CPU module (CONTEC CO., LTD. make)
	Personal Computer	Generic term of IBM PC/AT [®] and compatible DOS/V personal computer

* In this manual, the following products are called by new names.

Old Name	New Name	Remarks
GPPW	GX Developer	Generic term of SW□D5C-GPPW-E/SW□D5F-GPPW-E software packages

Chapter 2 SYSTEM CONFIGURATION

2.1 System Configuration at Installation of GT SoftGOT

2.1.1 System configuration

2

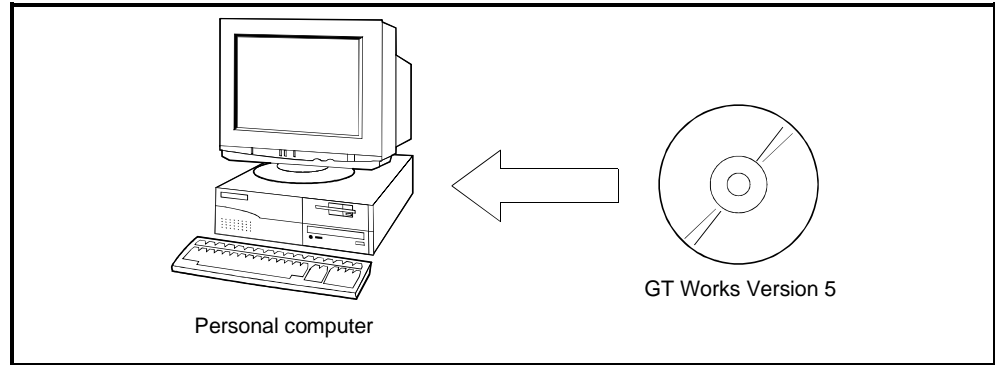

2.1.2 Operation environment

The following table indicates the operating environment of the personal computer where GT SoftGOT is installed.

Item	Description	
	DOS/V personal computer	PC CPU module
Computer main unit	Pentium® 200MHz or higher (Pentium II® 300MHz or higher recommended) based Personal computer that are compaible with windous operating system	Contec's MELSEC-Q series-compatible PC CPU module
Main memory	64M bytes or more (96M bytes or more recommended)	
Hard disk space	For installation	At the time of installation : 150M bytes or more
	For operation	At the time of operation : 50M bytes or more
Disk drive	CD-ROM drive is mandatory.	3.5 inch (1.44MB) floppy disk drive
Monitor	Resolution of 800x600 dots or more	
Operating system	Microsoft® Windows® 98 operating system, Microsoft® Windows® Millennium Edition operating system, Microsoft® WindowsNT® Workstation 4.0 operating system*1, Microsoft® Windows® 2000 Professional operating system	WindowsNT® Workstation 4.0 *1, Windows® 2000
Necessary software	GT Designer (SW5D5C-GOTR-PAKE Version D or later.)	
Necessary License key /License key FD	A9GTSOFT-LKEY-P *2	SW5D5F-SGLKEY-E
Mouse, keyboard, printer, CD-ROM drive	Ones that can be used with any of the above operating systems	

*1 When using GT SoftGOT, use a computer where WindowsNT® Workstation 4.0 of Service Pack 3 or later is installed.

*2 When using A9GTSOFT-LKEY-P, a parallel port (Centronix/printer connector) is required in an IBM-PC/AT compatible personal computer.

POINT

Depending on the language of your Operating System, this software may not start. In such a case, start this software after setting the Regional Settings within Control Panel of Windows® to "English".

2.2 System Configuration for GT SoftGOT Execution

(1) When GT SoftGOT is used on DOS/V personal computer

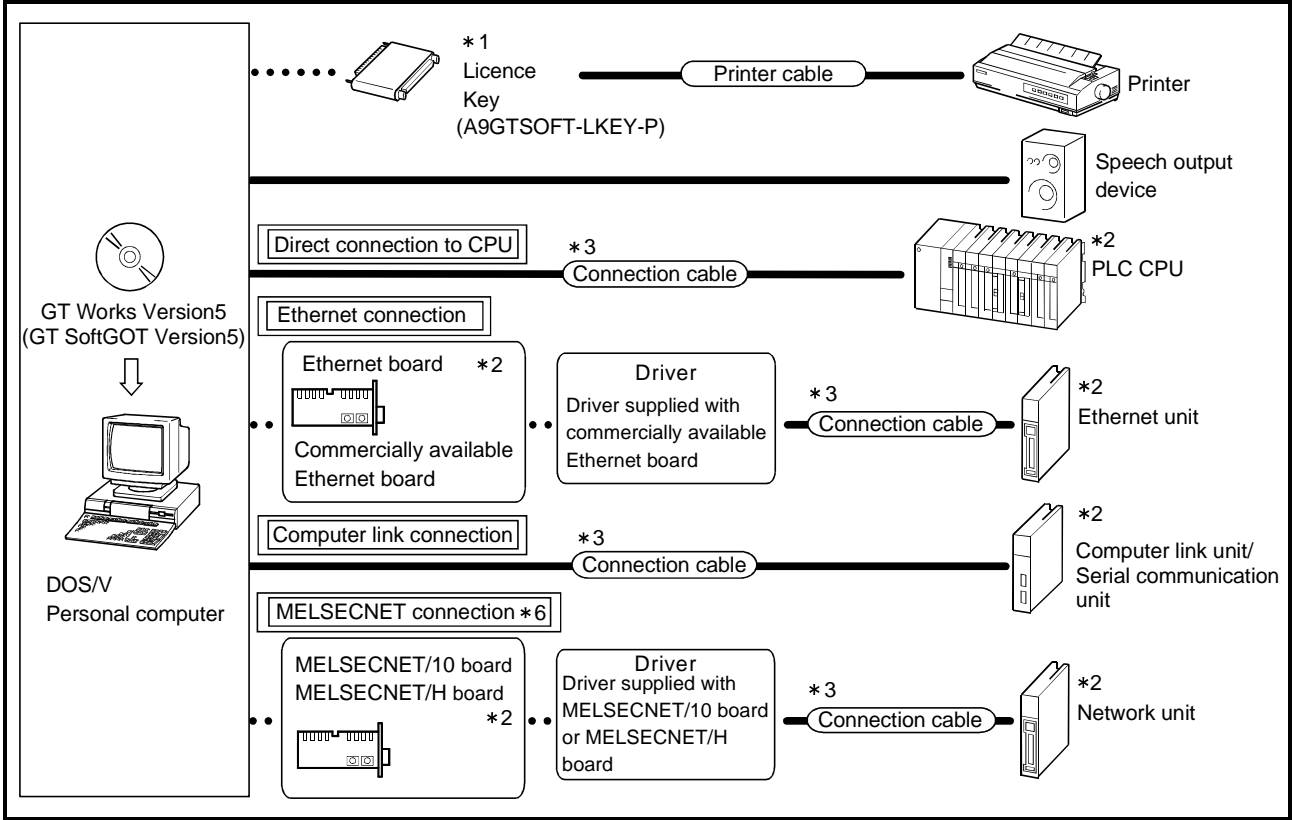

2

(2) When GT SoftGOT is used on PC CPU module

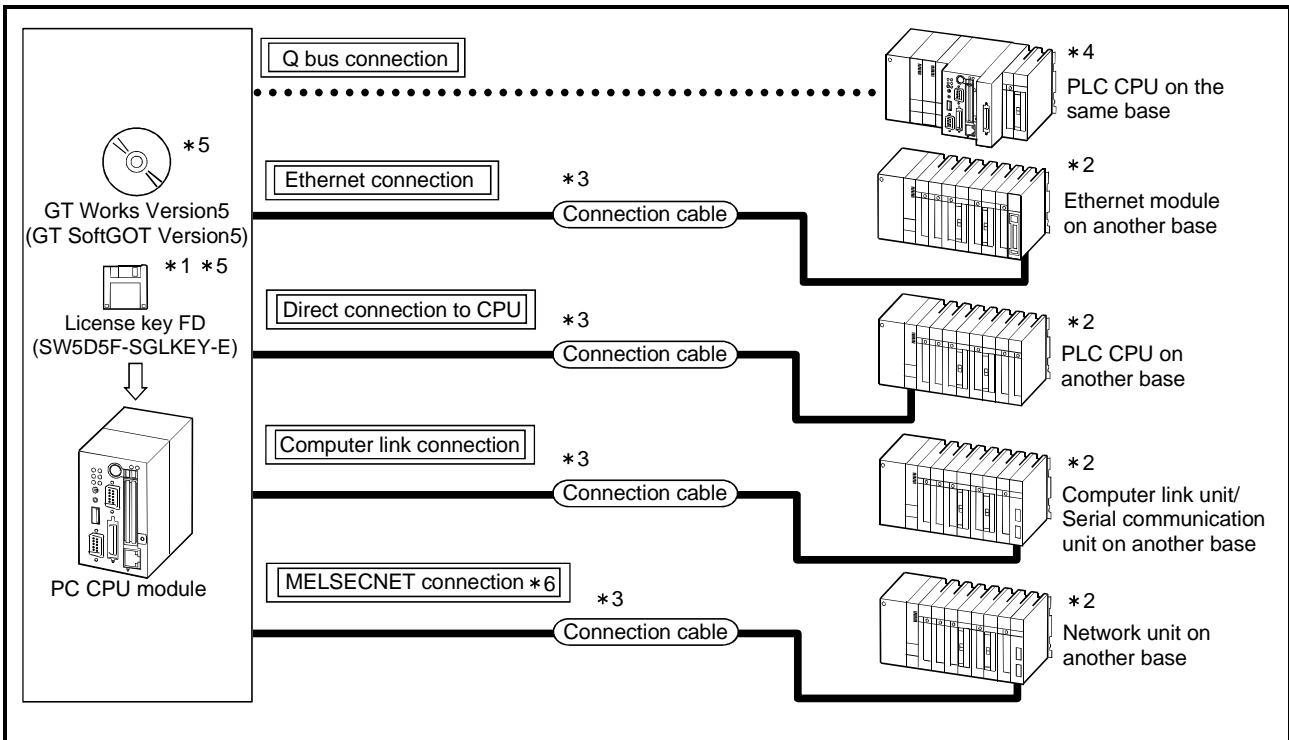

*1 If the license key / license key FD is required, contact your nearest Mitsubishi branch office or dealer.

*2 Refer to Section 2.3 for usable unit.

*3 Refer to Section 2.4 for cables for connection of the unit.

*4 When making Q bus connection, use Version 1.02 or later of the "PC module setting utility" of the PC CPU module. (The version of the PC module setting utility is displayed in "Version".)

*5 When installing GT Works Version 5 or a license key FD in a PC CPU module, a CD-ROM drive and a floppy disk drive dedicated for the PC CPU module are required. To purchase a PC CPU module and its related products, contact Contec Co., Ltd.

*6 MELSECNET(II)/B connection cannot be made.

2.3 Equipment that can Be Used Together with GT SoftGOT

2.3.1 PLC CPUs that can be connected

The following table indicates the PLC CPUs that may be connected to GT SoftGOT (personal computer).

Variety		Type
MELSEC-QCPU	QCPU (Q Mode)	Q00JCPU, Q00CPU, Q01CPU, Q02CPU, Q02HCPU, Q06HCPU, Q12HCPU, Q25HCPU, Q12PHCPU, Q25PHCPU
	QCPU (A Mode)	Q02CPU-A, Q02HCPU-A, Q06HCPU-A
MELSEC-QnACPU	QnACPU (Large type)	Q2ACPU (S1), Q2AHCPU (S1), Q3ACPU, Q4ACPU, Q4ARCPU
	QnACPU (Small type)	Q2ASCPU (S1), Q2ASHCPU (S1)
MELSEC-ACPU	ACPU (Large type)	A2UCPU (S1), A3UCPU, A4UCPU, A2ACPU (S1), A3ACPU, A1NCP, A2NCP (S1), A3NCP (Version L or later for the one with link, version H or later for the one without link of AnN (S1))
	ACPU (Small type)	A2USCPU (S1), A2USHCPU-S1, A1SCPU (S1), A1SHCPU, A2SCPU (S1) (Version C or later), A2SHCPU (S1), A1SJCPU, A1SJHCPU, A0J2HCPU (Version E or later) *5, A2CCPU (Version H or later) *5, A2CCPUC24, A2CJCPU *5
		A1FXCPU
Motion controller CPU		A171SHCPU *2, A172SHCPU *3, A173UHCPU (S1) *4, A273UHCPU (S3) *4
MELSEC-FXCPU *5		FX0,FX0N, FX0S, FX1, FX1N, FX1S, FX2, FX2C, FX2N, FX2NC

*1 Monitoring is allowed in the A1SHCPU range only.

*2 Monitoring is allowed in the A2SHCPU range only.

*3 Monitoring is allowed in the A3UCPU range only.

*4 The clock display function is unusable.

*5 For Q bus connection, only the QCPU compatible with a multiple PLC system can be monitored.

POINT
<ul style="list-style-type: none"> About the clock display function GT SoftGOT displays the clock data of the personal computer, not the clock data of the PLC CPU, while GOT reads and displays the clock data of the PLC CPU. The clock data of the PLC CPU and the personal computer must be set equal when performing control using the clock data.

2.3.2 Ethernet units and Ethernet boards/cards that can be used

(1) Ethernet Units

The table below lists the Ethernet units that can be used together with GT SoftGOT.

Item	Type	Connection CPU
Q series compatible E71	QJ71E71, QJ71E71-B2, QJ71E71-100	QCPU (Q mode)
QE71	AJ71QE71, A1SJ71QE71-B2, AJ71QE71-B5, A1SJ71QE71-B5, AJ71QE71N-B2, AJ71QE71N-B5T, A1SJ71QE71N-B2, A1SJ71QE71N-B5T	QnACPU
E71 *1,*2	AJ71E71-S3, A1SJ71-B2-S3, A1SJ71E71-B5-S3, AJ71E71N-B2, AJ71E71N-B5T, A1SJ71E71N-B2, A1SJ71E71N-B5T	QCPU (A mode), ACPU

*1 Monitoring is allowed in the AnACPU range only.

*2 GT SoftGOT does not allow connection of the AJ71E71, A1SJ71E71-B2 or A1SJ71E71-B5.

(2) Ethernet board/card

The following Ethernet boards/cards have been confirmed by Mitsubishi Electric to operate properly.

Maker Name	Type	Remarks
3COM make	EthernetLink III Lan PC Card	Ethernet board/card
Allied Telesis make	CenterCOM LA-PCM Ethernet PC Card LAN Adapter	
		RE2000 (ISA)

POINT

When GT SoftGOT is used on the PC CPU module, access is made from the Ethernet module communication port provided as standard for the personal computer CPU module.

2.3.3 Computer link units and serial communication units that can be used

The following table indicates the Computer link units and the serial communication units that may be connected to GT SoftGOT
 Connection via RS-422 communication cannot be used.

Item	RS-232C Communication	
MELSEC-Q Series (Q mode)	QJ71C24(-R2)	QJ71CMO
MELSEC-Q Series (A mode)	A1SJ71C24-R2	A1SJ71UC24-R2
MELSEC-QnA Series	AJ71QC24(-R2)	AJ71QC24N(-R2)
	A1SJ71QC24(-R2)	A1SJ71QC24N(-R2)
MELSEC-A Series	AJ71C24-S8	AJ71UC24
	A1SJ71C24-R2	A1SJ71UC24-R2
	A1SCPUC24-R2	A2CCPUC24

2.3.4 Network units and network boards that can be connected

(1) Network units

The following table indicates the network units that can be connected with GT SoftGOT.

Network	Type	Driver	Compatible OS
MELSECNET/H	QJ71LP21,QJ71LP21G, QJ71LP21-25, QJ71LP21S-25, QJ71BR11	PPC-DRV-01	WindowsNT® Workstation 4.0, Windows® 2000 Professional

(2) Network boards

The following table indicates the network boards that can be connected with GT SoftGOT.

Network	Type	Bus Format	Driver	Compatible OS
MELSECNET/10	A70BD-J71QLP23, A70BD-J71QLP23G, A70BD-J71QLR23G, A70BD-J71QBR13	ISA	SW3DNF-MNET10	Windows® 98, WindowsNT® Workstation 4.0
MELSECNET/H	Q80BD-J71BR11, Q80BD-J71LP21-25, Q80BD-J71LP21G	PCI	SW0DNC-MNETH10	Windows® 98, WindowsNT® Workstation 4.0, Windows® 2000 Professional

2.4 About the cable

2.4.1 Cables used for connecting directly to CPUs

The following cables/converter have been confirmed by us that proper operation can be performed.



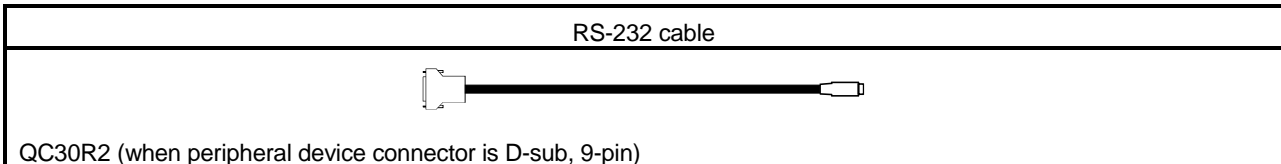

(1) QCPU

(a) Using the cable of Mitsubishi Electric make



(2) QnACPU, ACPU, Motion controller CPU, FXCPU

(a) Using the product of Mitsubishi Electric make

Peripheral Device Side (RS-232C cable)	RS-232C/RS-422 Converter	PLC CPU Side (RS-422 cable)
 <p>F2-232CAB-1 (when peripheral device connector is D-sub, 9-pin)</p>	 <p>FX-232AW(C)</p>	<p>For ACPU, Motion controller CPU, QnACPU, FX1/FX2CPU/FX2cCPU</p> <div style="text-align: center;">  </div> <p>FX-422CAB (0.3m) FX-422CAB-150 (1.5m)</p> <hr/> <p>For FX0/FX0s/FX0N/FX1s/FX1N/FX2N/FX2NCPU</p> <div style="text-align: center;">  </div> <p>FX-422CABO (1.5m)</p>

- When using the F2-232CAB or F2-232CAB-1 cable, use a compatible product. You cannot use an incompatible product. Check the type label indication on the cable to see if it is compatible or not.

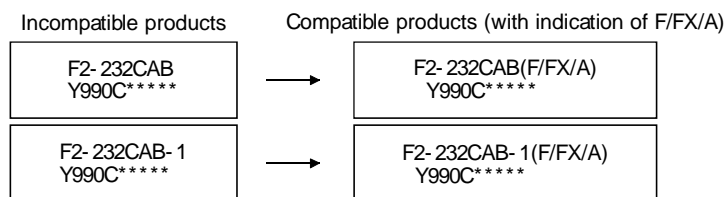

REMARK

- The cables/converter used with GT SoftGOT are the same as the cables/converter used with GX Developer.
- When GT SoftGOT is used on the PC CPU module, the converter/cables used with the DOS/V personal computer are usable.

2.4.2 Cables used for connecting via Ethernet

Make sure to use cables compatible with the Ethernet unit and Ethernet board/card to be used if the connection is made via Ethernet.

2.4.3 Cable used for connecting Computer link connection

The user needs to fabricate the RS-232C cable which is used to connect the GT SoftGOT and Computer link unit/serial Communication unit.
The cables connection diagram indicated below.

(1) For Q Series

The connector specifications are indicated below.

Pin No.	Signal code	Signal name	Signal direction Q compatible C24 ↔ GT SoftGOT
1	CD	Receive carrier detection	←
2	RD(RXD)	Receive data	←
3	SD(TXD)	Send data	→
4	DTR(ER)	Data terminal ready	→
5	SG	Send ground	↔
6	DSR(DR)	Data set ready	←
7	RS(RTS)	Request to send	→
8	CS(CTS)	Clear to send	←
9	RI(CI)	Call indication	←

1) Connection example which can turn ON/OFF CD signal (No. 1 pin)

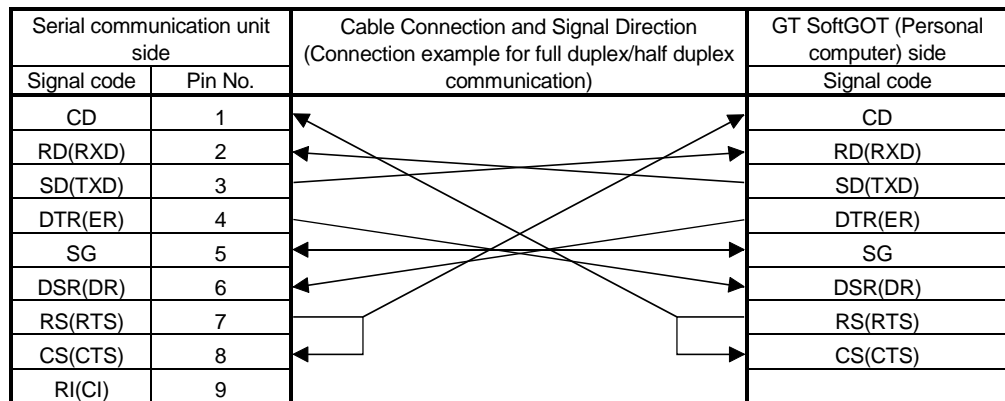

2) Connection example which cannot turn ON/OFF CD signal (No. 1 pin)
Connection example for exercising DC code control or DTR/DSR control

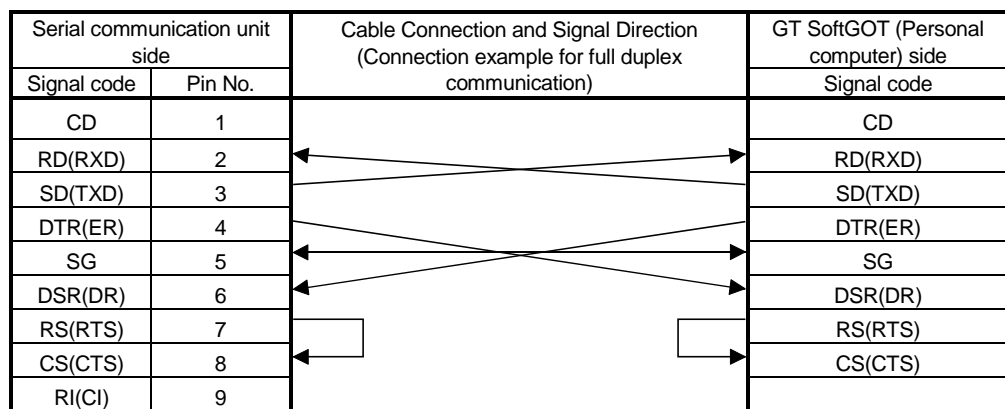

(2) For QnA Series (large-scale QC24(N))

1) Example of connection to an external device that allows the CD signal (No.8 pin) to be turned ON/OFF

Serial communication unit side		Cable Connection and Signal Direction (Connection example for full duplex/half duplex communication)	GT SoftGOT (Personal computer) side
Signal code	Pin No.		Signal code
FG	1	↔	FG
SD(TXD)	2	↔	SD(TXD)
RD(RXD)	3	↔	RD(RXD)
RS	4	↔	RS
CS(CTS)	5	↔	CS(CTS)
DSR(DR)	6	↔	DSR(DR)
SG	7	↔	SG
CD	8	↔	CD
DTR(ER)	20	↔	DTR(ER)

* DC code control or DTR/DSR control is enabled by connecting the QC24 (N) to an external device as shown above.

2) Example of connection to an external device that does not allow the CD signal (No. 8 pin) to be turned ON/OFF

Serial communication unit side		Cable Connection and Signal Direction (Connection example for full duplex communication)	GT SoftGOT (Personal computer) side
Signal code	Pin No.		Signal code
FG	1	↔	FG
SD(TXD)	2	↔	SD(TXD)
RD(RXD)	3	↔	RD(RXD)
RS	4	↔	RS
CS(CTS)	5	↔	CS(CTS)
DSR(DR)	6	↔	DSR(DR)
SG	7	↔	SG
CD	8	↔	CD
DTR(ER)	20	↔	DTR(ER)

* DC code control or DTR/DSR control is enabled by connecting the QC24 (N) to an external device as shown above.

(3) For QnA Series (compact-scale QC24(N))

1) Example of connection to an external device that allows the CD signal (No.1 pin) to be turned ON/OFF

Serial communication unit side		Cable Connection and Signal Direction (Connection example for full duplex/half duplex communication)	GT SoftGOT (Personal computer) side
Signal code	Pin No.		Signal code
CD	1		CD
RD(RXD)	2		RD(RXD)
SD(TXD)	3		SD(TXD)
DTR(ER)	4		DTR(ER)
SG	5		SG
DSR(DR)	6		DSR(DR)
RS(RTS)	7		RS(RTS)
CS(CTS)	8		CS(CTS)

* DC code control or DTR/DSR control is enabled by connecting the QC24 (N) to an external device as shown above.

2) Example of connection to an external device that does not allow the CD signal (No. 1 pin) to be turned ON/OFF

Serial communication unit side		Cable Connection and Signal Direction (Connection example for full duplex communication)	GT SoftGOT (Personal computer) side
Signal code	Pin No.		Signal code
CD	1		CD
RD(RXD)	2		RD(RXD)
SD(TXD)	3		SD(TXD)
DTR(ER)	4		DTR(ER)
SG	5		SG
DSR(DR)	6		DSR(DR)
RS(RTS)	7		RS(RTS)
CS(CTS)	8		CS(CTS)

* DC code control or DTR/DSR control is enabled by connecting the QC24 (N) to an external device as shown above.

(4) For A Series

1) Connection example 1 when the C24 (computer link unit) has a 25-pin connector

Computer link unit side		Cable Connection and Signal Direction	GT SoftGOT (Personal computer) side
Signal code	Pin No.		Signal code
FG	1		FG
SD(TXD)	2		SD(TXD)
RD(RXD)	3		RD(RXD)
RS	4		RS
CS(CTS)	5		CS(CTS)
DSR(DR)	6		DSR(DR)
SG	7		SG
CD	8		CD
DTR(ER)	20		DTR(ER)

2) Connection example 2 when the C24 (computer link unit) has a 25-pin connector

Computer link unit side		Cable Connection and Signal Direction	GT SoftGOT (Personal computer) side
Signal code	Pin No.		Signal code
FG	1		FG
SD(TXD)	2		SD(TXD)
RD(RXD)	3		RD(RXD)
RS	4		RS
CS(CTS)	5		CS(CTS)
DSR(DR)	6		DSR(DR)
SG	7		SG
CD	8		CD
DTR(ER)	20		DTR(ER)

* If the connection between the computer link module and the GPPW is made in the manner shown above, designate "without CD terminal check".

3) Connection example 1 when the C24 (computer link unit) has a 9-pin connector

Computer link unit side		Cable Connection and Signal Direction	GT SoftGOT (Personal computer) side
Signal code	Pin No.		Signal code
CD	1		CD
RD(RXD)	2		RD(RXD)
SD(TXD)	3		SD(TXD)
DTR(ER)	4		DTR(ER)
SG	5		SG
DSR(DR)	6		DSR(DR)
RS(RTS)	7		RS(RTS)
CS(CTS)	8		CS(CTS)

4) Connection example 2 when the C24 (computer link unit) has a 9-pin connector

Computer link unit side		Cable Connection and Signal Direction	GT SoftGOT (Personal computer) side
Signal code	Pin No.		Signal code
CD	1		CD
RD(RXD)	2		RD(RXD)
SD(TXD)	3		SD(TXD)
DTR(ER)	4		DTR(ER)
SG	5		SG
DSR(DR)	6		DSR(DR)
RS(RTS)	7		RS(RTS)
CS(CTS)	8		CS(CTS)

*1 DC code control or DTR/DSR control is enabled by connecting the DTR and DSR signals of the computer link module to an external device as shown above.

*2 If the connection between the computer link module and the GPPW is made in the manner shown above, designate "without CD terminal check".

2.4.4 Cables used for MELSECNET connection

The cables used for MELSECNET connection are the same as the fiber-optic cables and coaxial cables used in the MELSECNET/10 or MELSECNET/H system.

For cable details, refer to the MELSECNET/10 Network System Reference Manual or MELSECNET/H Network System Reference Manual.

2.5 Access range for monitoring

2.5.1 Access range that can be monitored when CPU direct connection/computer link connection

When GT SoftGOT is connected to a QnACPU, other stations besides the QnACPU cannot be monitored. In all other cases the access range that can be monitored is the same as for the GOT-A900 Series. Refer to the GOT-A900 Series User's Manual (GT Works Version5/GT Designer Version5 compatible Connection System Manual) for the access range of CPUs that can be monitored.

2.5.2 Access range that can be monitored when connecting via Ethernet

By using the GT Designer's Ethernet setting, the designated Ethernet module can be monitored.

Communications cannot be made via the MELSECNET/B, MELSECNET(II), MELSECNET/10

Communication via a router or a gateway can be performed only with the QCPU (Q mode).

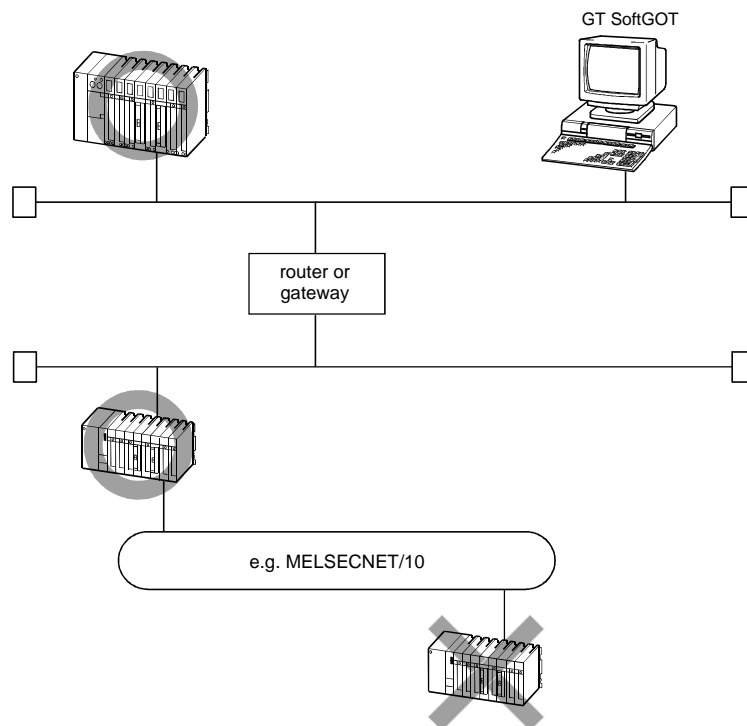

POINT

Refer to Section 5.3 for how to establish an Ethernet connection.

2.5.3 Access range that can be monitored for Q bus connection (only when PC CPU module is used)

In a multiple PLC system configuration, access can be made from the personal computer CPU module to the other CPU via the Q bus.

Access to the other station cannot be made from the PC CPU module via CC-Link.

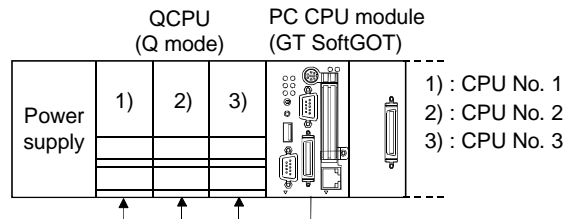

2.5.4 Access ranges that can be monitored for MELSECNET connection

(1) Host access range

When access is made to the host, all devices of the MELSECNET/10 or MELSECNET/H board can be monitored.

Device	MELSECNET/H Board (in MELSECNET/H Mode)	MELSECNET/H Board (in MELSECNET/10 Mode) MELSECNET/10 Board
X (LX)	X0 to X1FFF (8192 points)	
Y (LY)	X0 to X1FFF (8192 points)	
B (LB)	B0 to B3FFF (16384 points)	B0 to B1FFF (8192 points)
W (LW)	W0 to W3FFF (16384 points)	W0 to W1FFF (8192 points)
SB	SB0 to SB1FF (512 points)	
SW	SW0 to SW1FF (512 points)	

(2) Other station access range

When access is made to the other station, all devices of the accessed CPU can be monitored.

(3) Access to other network

When access is made to the other network via the CPU, the CPU on the MELSECNET/10, MELSECNET/H or Ethernet network can be accessed. (The CPUs that can be accessed on the Ethernet network are the QCPU (Q mode) and QnACPU only.)

POINT

To monitor the other network, the routing parameters of the MELSECNET/10 board or MELSECNET/H board utility must be set.
For the setting of the routing parameters, refer to the MELSECNET/10 Interface Board User's Manual or MELSECNET/H Interface Board User's Manual.

REMARK

- The access ranges of GT SoftGOT are the same as those of GX Developer.
- GT SoftGOT differs from GOT in some specifications.
The following table indicates the differences between GT SoftGOT and GOT.

Item	GT SoftGOT	GOT
QCPU (Q mode), QnACPU monitor range	All devices	Within AnACPU range
Multi PLC monitor	Possible	Impossible
Other network monitor	Possible	Impossible

Chapter 3 SPECIFICATIONS

3.1 Specifications of the GT SoftGOT

The following specifications of the GT SoftGOT.

Item	Specifications
Resolution (dots)	640×480, 800×600, 1024×768, 1280×1024
Display color (color)	256
Memory capacity (byte)	9M
Connection form	Direct connection to CPU, Ethernet connection, Q bus connection*2, Computer link connection

*1 Usable only when GT SoftGOT is used on the PC CPU module.

POINT

- If the resolution of the personal computer used is the same as that of GT SoftGOT, it is recommended to hide the frame and menu part using the full screen mode function (refer to Section 6.7).
If the full screen mode function is not used, the top/bottom and left/right parts of the display will be off screen slightly depending on the frame and menu part.
- The resolution of the monitor data created in GT Designer and the resolution of GT SoftGOT must be the same.
If they are different, the screen will be displayed in the following manner:
 - 1) If the resolution of the monitor data is higher than the resolution of GT SoftGOT Graphics that are off-screen will not be displayed.
 - 2) If the resolution of the monitor data is lower than the resolution of GT SoftGOT The resolution of GT SoftGOT has the priority in the moving range of window screens, position of messages displayed in the alarm flow function, and display of the superimposed window.
Graphics not defined within the resolution set in the monitor data are not refreshed. (Out-of-date graphics may remain in the parts outside the area defined within the resolution.) This can be prevented in the following way:
 - (a) When using monitor data created with resolutions of 640 x 400 dots or 320 x 240 dots in GT SoftGOT, change the GOT type (resolution) of the monitor data created in GT Designer to the resolution used in GT SoftGOT.
 - (b) Use the mouse to change the screen size of GT SoftGOT to the size of the monitor data created in GT Designer.

3.2 Functions that cannot be Used

Note that the following functions cannot be used on GT SoftGOT.

Function category	Function name		
Object functions*1	Test function, Touch key function (part of extension) *6	Barcode function,	Operation Panel function*5
Extension function*2	System monitor function*3		
Option functions*2	Ladder monitor function*3, Network monitor function*3,	Special unit monitor function, Motion monitor function,	List editor function*3, Servo amplifier monitor function
Other functions	Transparent function, Sound function*4,	Human sensor function, Gateway function	Brightness adjustment function,

*1 For function details, refer to the GT Works Version 5/GT Designer Version 5 Reference Manual.

*2 For function details, refer to the GOT-A900 Series Operating Manual (GT Works Version 5/GT Designer Version 5 compatible Extended • Option Functions Manual).

*3 The equivalent functions can be obtained by using GT SoftGOT and GX Developer on the same personal computer.

*4 Unusable when GT SoftGOT is used on the PC CPU module.

*5 By using the keyboard function, an equivalent function can be used.

*6 The following touch keys (extension) are unusable.

- Ladder monitor
- Clock setting
- Brightness adjustment
- Servo amplifier monitor
- System monitor
- Screen clean-up
- List editing
- Special module monitor
- Network monitor
- Motion monitor

POINT

- About the clock display function

While GOT reads and displays the clock data of the PLC CPU, GT SoftGOT displays the clock data of the personal computer, not the clock data of the PLC CPU.

When performing clock data-based control, etc., match the clock data of the PLC CPU and personal computer.

(1) About utility functions

(a) About display of utility screen

GT SoftGOT does allow two points on the display section to be touched together.

To display the utility screen, therefore, you need to preset the touch key for displaying the utility screen at the time of screen creation.

(b) Usability of utility functions

When using the utility functions on GT SoftGOT, not that some functions are unusable.

The following table indicates whether the utility functions are usable or not on GT SoftGOT.

○: Usable ×: Unusable

Item	Usability
System monitor	×
Network monitor	×
List editor	×
Ladder monitor	×
Motion monitor	×
Special unit monitor	×
Servo amplifier monitor	×
Memory information	×
Screen & OS copy	×
Set up	○
Clock	×
Screen clean up	×
Password	○
Self-test	×

POINT

- In the setup of the utility functions, some functions are inoperative if set.

The following table indicates whether they are operative or not on GT SoftGOT.

○: Operative △: Partly restricted ×: Inoperative

Item	Operability	Description
Buzzer volume	△	When Microsoft® Windows® 98 operating system / Microsoft® Windows® Millennium Edition operating system is used, "LONG" and "SHORT" of the buzzer volume are not reflected.
Outside speaker	○*1	Operates.
Screen save time	×	May be set but does not function.
Screen save light	×	May be set but does not function.
Language	○	Operates.

*1 Unusable when GT SoftGOT is used on the PC CPU module.

3.3 Restrictions on and Instructions for use of GT SoftGOT

3.3.1 Restrictions on and instructions for GT SoftGOT

(1) Restriction on starting up GT SoftGOT

- More than one GT SoftGOT cannot be started up on one personal computer.

(2) Monitor data that may be monitored

- If you use on GT SoftGOT the monitor data of GT Designer earlier or the monitor data converted with GT Converter, proper operation may not be performed.

The monitor data created with GT Designer earlier or the monitor data converted with GT Converter should be read once on GT Designer later and saved.

(3) About object functions

- If you perform a memory card save with the alarm history function or the recipe function, data is saved on the hard disk.

Also, data can not be output directly to the printer using the report function, hard copy function, etc.

A print image (TXT/CSV/BMP format file) is saved to the personal computer's hard disk, so output each file to the printer separately.

The saving folder will vary according to the GOT type setting in the option settings, so take care.

Each bit of data is stored in the folder listed below on the personal computer's hard disk.

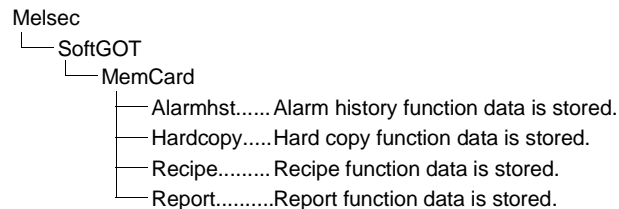

With the recipe function, if there is a recipe file present in the PC card, a new recipe file will not be created as with the actual GOT.

Because of that, if there is a recipe file in the MemCard or Recipe folder that differs from the read monitor data's recipe function settings, reading data from or writing data to the recipe file may not operate normally.

In these cases, delete the recipe files in the MemCard or Recipe folder before reading the monitor data.

- A file saved as a printing image will not be deleted even if GT SoftGOT is exited. Because of that, files saved as printing images will accumulate on the personal computer's hard disk, and the GT SoftGOT may not operate due to a lack of available open space on the hard disk.
If the printing trigger is frequently set to ON and monitor data is used, check that there is enough available open space on the personal computer's hard disk, and delete printing files if necessary.
- If Wordpad or Memopad were used to open saved printing image files (TXT files), the display of the character spacing may be slightly out of line. If the character spacing is out of line, adjust the character font or font size.
- When setting the odd point of 16-bit data as the first device with the recipe function at the time of FXCPU connection, use the device of CN199 or earlier.

3.3.2 Restrictions on and instructions for PLC CPU connection

- GT SoftGOT supports only the following connection forms.

Connection form	Description
CPU direct connection	Communication with the QCPU, QnACPU, ACPUCPU, motion controller CPU or FXCPU can be made.
Ethernet connection	Communication via the Ethernet module set on GT Designer can be made.
Q bus connection	Communication with the other CPU on the base loaded with the personal CPU module can be made (Allowed only when GT SoftGOT is used on the personal computer CPU.)
Computer link connection	Communication via a computer link unit or a serial communication unit can be made.
MELSECNET/10, MELSECNET/H connection	Communication via a network module can be made.

Bus connection, CC-Link connection and third party PLC connection are not allowed.

Refer to Section 2.3 for the CPU that can be connected with GT SoftGOT.

- When connecting GT SoftGOT to FX0, FX0S, FX1, FX1S, FX2 or FX2c via 2PIF, use 2PIF of Ver 3.01A or later.
- When connecting GT SoftGOT to the function extension board of the FXCPU, you must make the following settings on the FXCPU side.
 - 1) On GX Developer, choose "PLC parameter"->"PLC System setting (2)" and click the checked "Communication setting" check box.
 - 2) Set "0" in device "D8120".
- When GT SoftGOT is connected to the QnACPU, note that any other station than the QnACPU cannot be monitored.
The access ranges of the other network systems that can be monitored are the same as those of the GOT.

Chapter 4 SCREEN CONFIGURATION OF GT SOFTGOT

4.1 Screen Configuration and Various Tools of GT SoftGOT

This section describes configuration and various tools of GT SoftGOT.

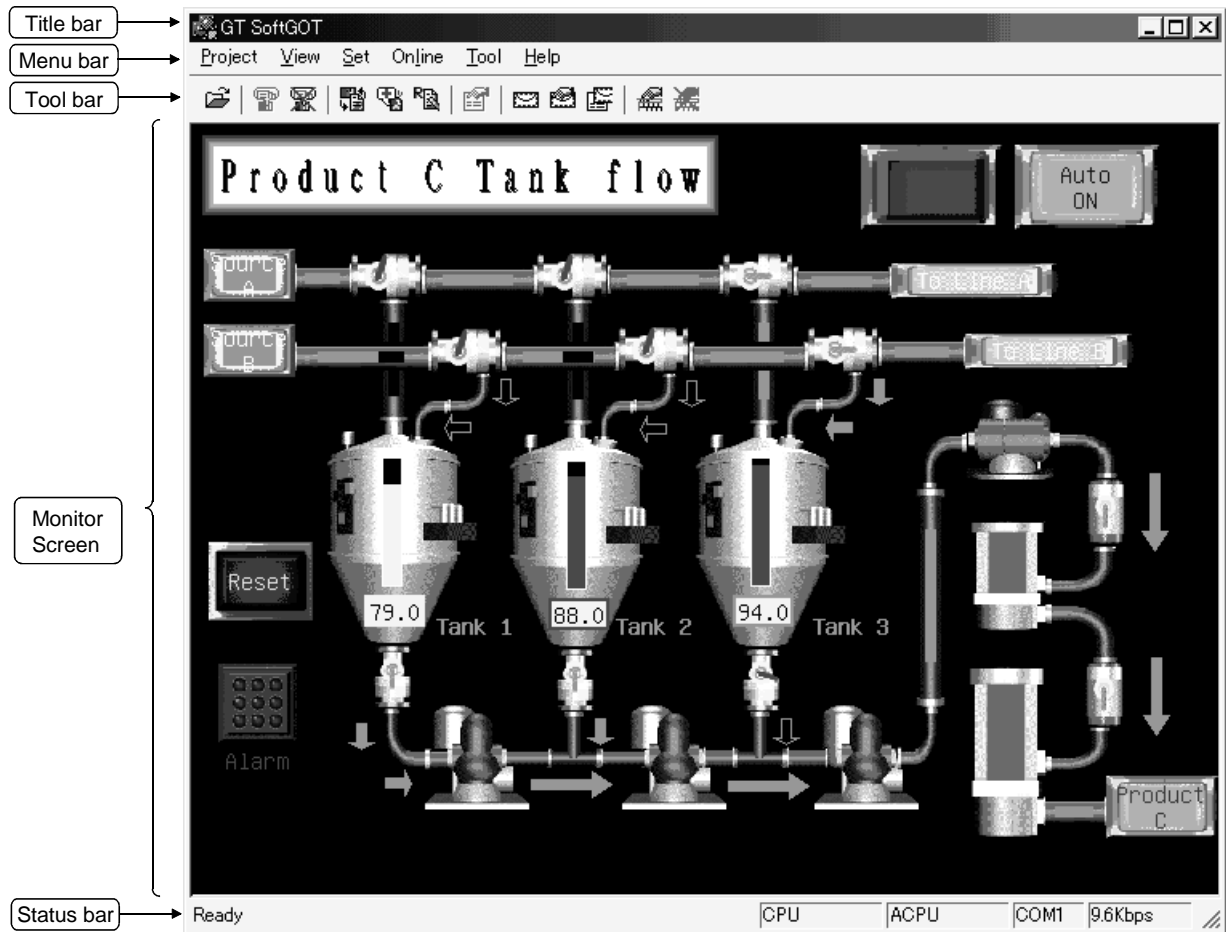

4



*1 For the explanations of the title bar, menu bar and drop-down menu, refer to the GT Works Version 5/GT Designer Version 5 Reference Manual.

(1) Tool bar

Items allocated on the menu bar are displayed in buttons.
Move the cursor to the tool button and click it. The function starts.

1) 2) 3) 4) 5) 6) 7) 8) 9) 10) 11) 12)

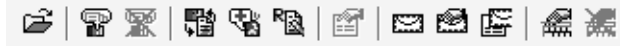

Tool button names

| Number | Name | Description |
|--------|-----------------------------|--|
| 1) | Open project | Opens the project data created on GT Designer. |
| 2) | Start of monitoring | Starts monitoring. |
| 3) | End of monitoring | Ends monitoring. |
| 4) | Refer to Recipe data | References recipe data/print file. |
| 5) | Refer to Alarm History data | References alarm history data/print file. |
| 6) | Refer to Report data | References report logging data/print file. |
| 7) | Option Setup | Sets the option functions. |
| 8) | Mail Setup | Sets the mail transmission destination. |
| 9) | Mail Condition | Enables/disables the mail transmission setting defined with GT Designer. |
| 10) | Mail History | References the mail transmission history. |
| 11) | KeyBoard Enable | Enables input using the keyboard function when selected. |
| 12) | KeyBoard Disable | Disables input using the keyboard function when selected. |

4

(2) Status bar

The communication setting of GT SoftGOT defined in the option setting is displayed here.

1) 2) 3)

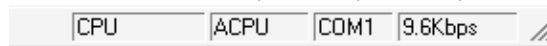

Description of each status bar

| Number | Description |
|--------|--|
| 1) | Type of CPU defined in the option setting |
| 2) | Communication port on the personal computer side defined in the option setting |
| 3) | Transmission speed of GT SoftGOT and the CPU defined in the option setting |

POINT

You can make selection to display or hide the toolbar and status bar.
Choosing "View" - "Toolbar" or "Status bar" on the menu bar displays or hides the toolbar or status bar.

Checked : The toolbar/status bar is displayed.

Unchecked : The toolbar/status bar is hidden.

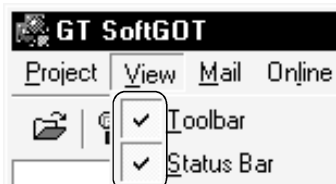

4.2 Menu Configuration

(1) Menu bar

This section lists and describes the commands assigned to the menu bar.

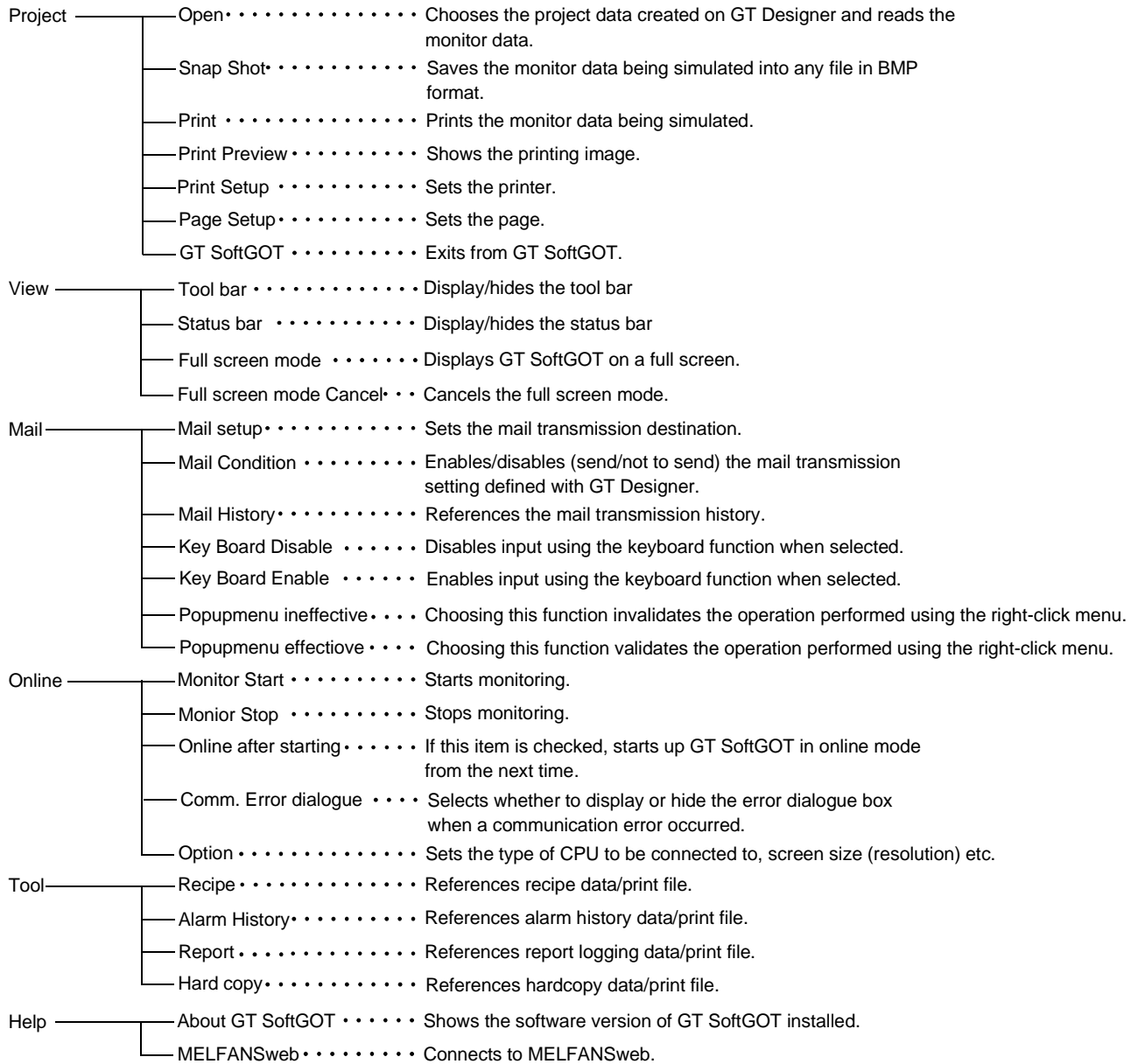

(2) Right-clicking the mouse

The list of the commands assigned to the mouse right-click menu will be explained.

The functions of the commands are the same as those of the commands in (1) Menu bar.

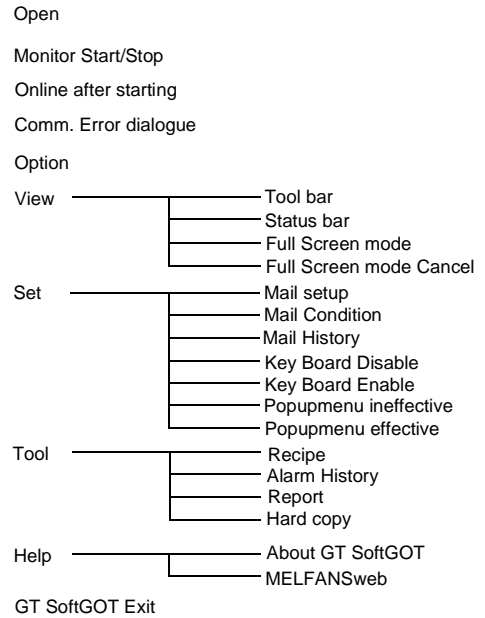
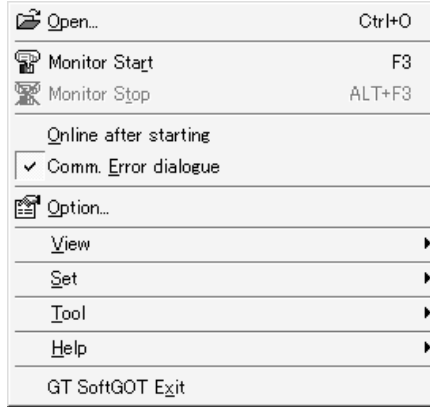

Chapter 5 GT SOFTGOT OPERATING METHOD

5.1 General Procedure for Monitoring with GT SoftGOT

The following shows a general procedure for monitoring with GT SoftGOT after installation of GT SoftGOT.

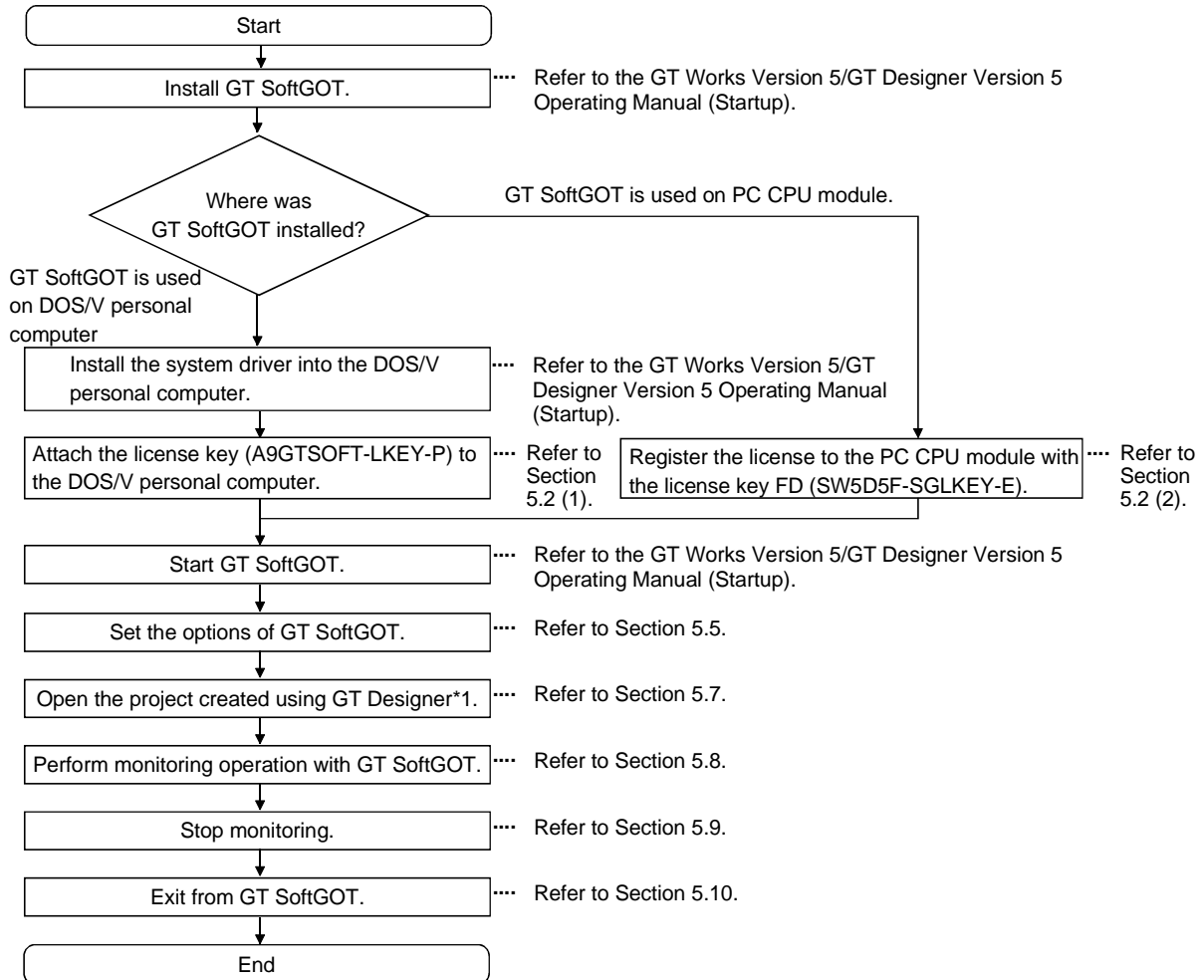

* 1 Monitoring is started if the previously opened project is already open. (Refer to Section 5.5)

POINT

It is also possible to start up GT SoftGOT automatically when Windows® is started up. Refer to Section 5.9 for how to start up GT SoftGOT automatically.

5.2 How to Use the License Key/License Key FD

When using GT SoftGOT, you must always use the following license key/license key FD to make the license right of GT SoftGOT recognized.

- DOS/V personal computer : License key (A9GTSOFT-LKEY-P)
- PC CPU module : License key FD (SW5D5F-SGLKEY-E)

How to use the license key/license key FD will be described.

(1) When using GT SoftGOT on DOS/V personal computer

When using GT SoftGOT on the DOS/V personal computer, always attach the license key (A9GTSOFT-LKEY-P) to the DOS/V personal computer.

If monitoring with GT SoftGOT is performed without attaching the license key to the personal computer, GT SoftGOT will automatically be terminated after approximately 10 minutes.

Moreover, if the system driver has not been installed on the DOS/V personal computer, GT SoftGOT does not recognize that the license key is attached.

Therefore, make sure to install the system driver as well.

Refer to the GT Works Version5/GT Designer Version5 Operating Manual (Start up Manual) for how to install the system driver.

Attach the license key in the following manner:

- 1) Attach the license key to the parallel port (Centro/printer connector) of the DOS/V personal computer.
- 2) Connect the printer cable to the license key when a printer is used.

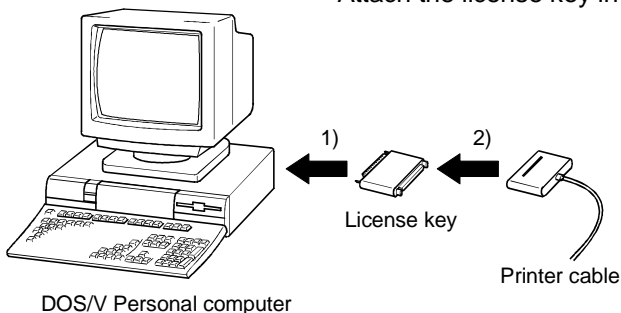

POINT

- Fasten the license key securely to ensure that it will not come off.
If the license key comes off while monitoring is performed with GT SoftGOT, GT SoftGOT will automatically be terminated in about 10 minutes as in the case where monitoring is executed without the license key being attached.
- If a printer switch is used, connect the license key before the printer switch (on the DOS/V personal computer side).
- If a parallel port is not provided as standard equipment, as in the case of notebook personal computers, an external option compatible with the notebook personal computer used is required.
- The following devices cannot be used at the same port as the license key:
 - 1) SCSI interface for printer port
 - 2) FDD/HDD/CD-ROM/ZIP drive connected to printer port
 - 3) Devices that use a data transmission method other than the standard network specification, including printer port communication type Interlink and Centro printer interface
- If the DOS/V personal computer used is a Fujitsu-made FM/V Series computer, make sure to shut off the power supply to the DOS/V personal computer after installing the system driver, and then restart the DOS/V personal computer to use GT SoftGOT.

(2) When using GT SoftGOT on PC CPU module

When using GT SoftGOT on the PC CPU module, always register the license with the license key FD (SW5D5F-SGLKEY-E/license registration package for PC CPU module).

If you execute monitoring using GT SoftGOT without attaching the license key FD to the personal computer, GT SoftGOT will automatically be terminated in about 10 minutes.

(a) Registering the license

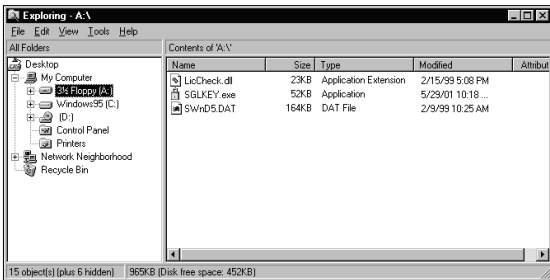

- 1) Start Explorer and click the drive where the license key FD is inserted.
Double-click "SGLKEY.exe".
To display Explorer, choose [Start]-[Programs]-[Explorer].



- 2) Click the picture of the key.
As the license registration confirmation dialog box appears, click the [Yes] button.



- 3) Click the [Close] button.

(b) Canceling the license

When uninstalling GT SoftGOT, cancel the license with the license key FD.

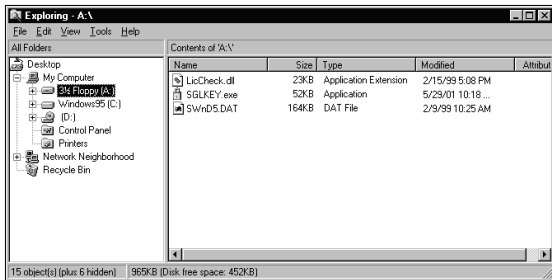

- 1) Start Explorer and click the drive where the license key FD is inserted.
Double-click "SGLKEY.exe".
To display Explorer, choose [Start]-[Programs]-[Explorer].



- 2) Click the picture of the key.
As the license cancellation confirmation dialog box appears, click the [Yes] button.



- 3) Click the [Close] button.
In this status, the license of the product is canceled and the license right is held by the license key FD.

| POINT |
|--|
| <p>(1) The license is not made valid if you attach the license key designed for DOS/V personal computer (A9GTSOFT-LKEY-P) to the PC CPU module.</p> <p>(2) About the license key FD (SW5D5F-SGLKEY-E)</p> <p>(a) Use the license key FD as purchased.
(You cannot use the license key FD that was created by copying.)</p> <p>(b) Save the license key FD carefully.</p> <p>(c) Never perform any of the following operations for the license key FD.
Performing any of such operations will damage the license key FD.</p> <ol style="list-style-type: none">1) FD formatting2) Write of file to FD3) Copying of file from/to FD (to/from other drive)4) Deletion of file on FD, changing of file name, changing of file attributes5) Running of analyzing tool (e.g. SCANDISK) for FD <p>(d) When canceling the license with the license key FD, use the license key FD that was used to register the license.</p> |

5.3 How to set up the Ethernet connection

| |
|---|
| POINT |
| <ul style="list-style-type: none"> • Read the manual for the Ethernet unit to be used thoroughly and understand it fully before proceeding with setting up the Ethernet connection. • If many devices (including GT SoftGOT) are connected, line traffic may become dense, causing a time-out error. If a time-out error occurs, reduce the number of connected devices or increase the time-out value in the option setting of GT SoftGOT. |

5.3.1 When using E71

For communication from GT SoftGOT via the E71, there are the following setting items and precautions. The explanations in this section will be made for the following system configuration.

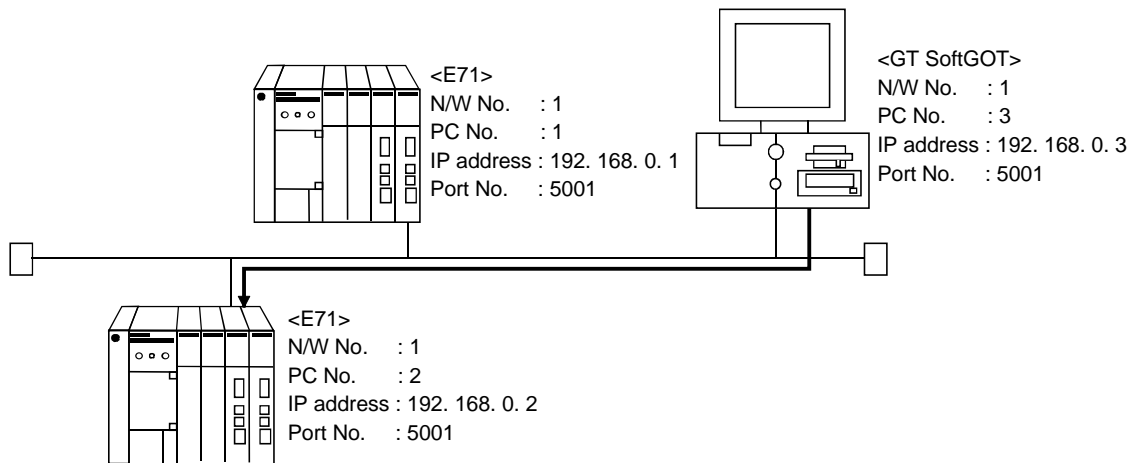

| |
|---|
| POINT |
| <p>The "N/W No." and "PLC No." to be specified for Ethernet connection to the E71 should be those set as desired on GT Designer.</p> <p>Refer to item (6) in this section for how to set up the Ethernet unit, network number of GT SoftGOT, personal computer number, IP address, and port number.</p> |

Procedure for communications via E71

Restrictions

- (a) Communications cannot be made via the MELSECNET/B, MELSECNET(II), MELSECNET/10
- (b) Communications can be made only within the same segment. Communication cannot be made via the router or gateway.

(1) Compatible models

AJ71E71-S3, A1SJ71E71-B2-S3, A1SJ71E71-B5-S3, AJ71E71N-B2, AJ71E71N-B5T, A1SJ71E71-B2, A1SJ71E71N-B5T

(2) E71 switch settings

| | AJ71E71-S3,
AJ71E71N-B2, AJ71E71N-B5T,
A1SJ71E71N-B2, A1SJ71E71N-B5T | A1SJ71E71-B2-S3, A1SJ71E71-B5-S3 |
|--|--|--|
| Operation mode setting switch | 0 (online mode) | 0 (online mode) |
| Communications condition setting switch | SW2 OFF (BIN code) | SW2 OFF (BIN code) |
| CPU communications timing setting switch | SW7 ON (online program correction enabled) | SW3 ON (online program correction enabled) |

(3) Sequence programs

Initial processing and communication line open processing sequence programs are needed. Necessary communication parameters and sequence program examples will be given below.

(a) Communication parameters

The following are the communication parameter setting examples.

| Setting item | Set value |
|--------------------------|-------------|
| Application setting*1 | 100H |
| IP address of E71 | 192.168.0.2 |
| E71 port number | 5001 |
| IP address of other node | FFFFFFFF |
| Other node port number | FFFF*2 |

*1: Value specified for application setting

The user can change the settings of 1), 2) and 3).
4), 5) and 6) are fixed settings.

The following shows details of the application setting.

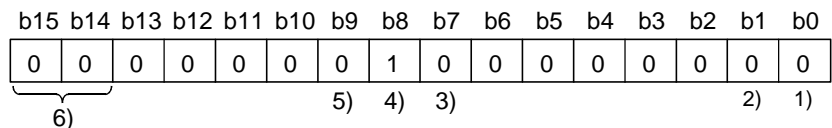

- 1): Fixed buffer application
0: For send/no communication
1: For receive
- 2): Existence check
0: No
1: Yes
- 3): Paring open
0: No
1: Yes
- 4): Communication system (Set to 1: UDP/IP)
- 5): Fixed buffer communication (Set to 0: With procedure)
0: With procedure
1: Without procedure
- 6): Open system (Set to 00: Active, UDP/IP)

*2: The other node port number is a fixed setting.
The user can change the other settings.

(b) Sequence program

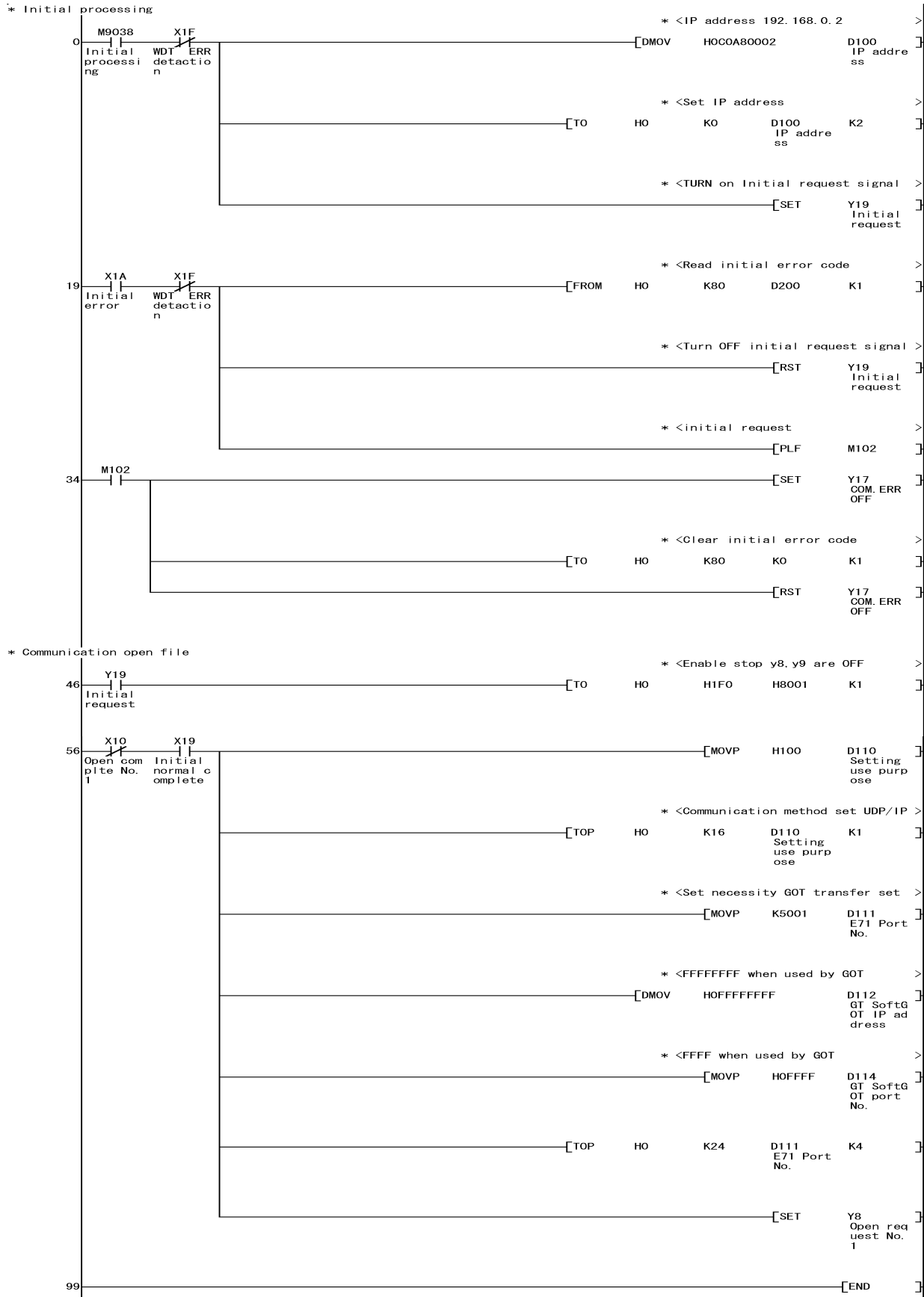

In a communications-ready status, the E71's RUN LED comes on and RDY LED flickers.

(4) Setting on the personal computer

Set the IP address.

(5) Communications check

When the preparations for communications via the E71 are complete, execute the Ping command in the MS prompt of Windows®.

When connections are OK

```
C:\>ping 192. 168. 0. 2
```

```
Reply from 192. 168. 0. 2:bytes=32 time<10ms TTL=32
```

When connections are not good

```
C:\>ping 192. 168. 0. 2
```

```
Request timed out.
```

If ping does not pass through, check the cable and unit connections and Windows® side IP address and other settings.

| POINT |
|---|
| It is also possible to perform the Ping test using GX Developer (SW6D5C-GPPW 6.01B or later).
Refer to the Operating Manual of GX Developer for more details on the Ping test. |

(6) Settings with GT Designer and GT SoftGOT

- (a) Make the following settings for the E71 to be monitored in "Ethernet Setting" of GT Designer.

Refer to the Help function of GT Designer for details of Ethernet setting.

| Setting Item | Description |
|--------------|--|
| N/W No. | Set any number. |
| PLC No. | Set any number. |
| IP address | Set the IP address assigned to the connected E71. |
| Port No. | Set the port No. of the connection target E71 set in the sequence program. |

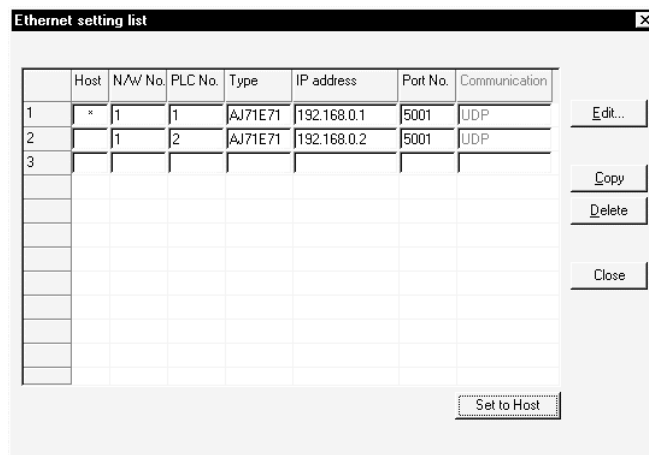

- (b) Define the settings of GT SoftGOT in "Option Setting" of GT SoftGOT. Refer to Section 5.4 for Option setting.

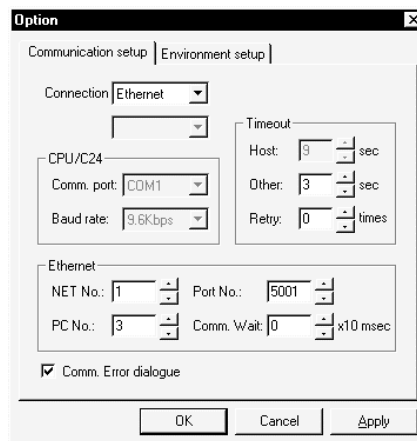

5.3.2 When using QE71

For communication from GX Developer via the QE71, there are the following setting items and precautions. The explanations in this section will be made for the following system configuration.

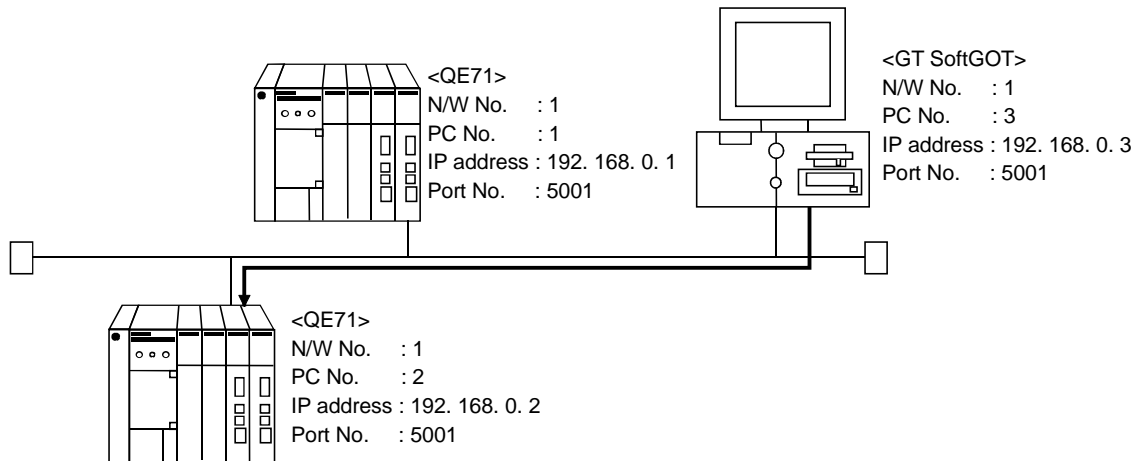

POINT

The "port No." specified for Ethernet connection to the QE71 is fixed at "5001". Refer to item (5) in this section for how to set up the Ethernet unit, network number of GT SoftGOT, personal computer number, IP address, and port number.

Procedure for communications via QE71

Restrictions

- (a) Communications cannot be made via the MELSECNET/B, MELSECNET(II), MELSECNET/10.
- (b) Communication cannot be made via the router or gateway.

(1) Compatible models

Use the QE71 and PLC whose function version is B or later.

(2) QE71 switch settings

Operation mode setting switch 0 (online)

Automatic start mode SW3 ON

When SW3 is ON, initial processing is performed independently of Y19 (initial processing request). Communications are also enabled if the CPU module is STOPped.

For the way to perform initial processing using Y19 (initial processing request), refer to the AJ71QE71 User's Manual and create an initial processing program.

(3) Parameter setting (Setting with GX Developer)

On the MELSECNET/Ethernet network parameter setting screen, set the network type, starting I/O No., network No., group No., station number and IP address.

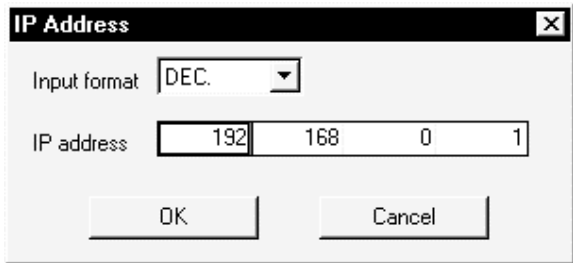
| Item | Setting Screen Examples | | | | | | | | | | | | | | | | | | | | | | | | | | | | | | | | | |
|---------------------|---|------------------------------|-------------|-------------|--------------|----------|----------|---------------|------|------|-------------|---|---|----------------|--|--|-----------|---|---|-------------|---|---|---------------|---------------|---------------|--|------------------------------|------------------------------|--|----------------|----------------|--|---------------------|---------------------|
| Ethernet Parameters | <table border="1"> <thead> <tr> <th></th> <th>Module No.1</th> <th>Module No.2</th> </tr> </thead> <tbody> <tr> <td>Network type</td> <td>Ethernet</td> <td>Ethernet</td> </tr> <tr> <td>Start I/O No.</td> <td>0040</td> <td>0060</td> </tr> <tr> <td>Network No.</td> <td>1</td> <td>1</td> </tr> <tr> <td>Total stations</td> <td></td> <td></td> </tr> <tr> <td>Group No.</td> <td>0</td> <td>0</td> </tr> <tr> <td>Station No.</td> <td>1</td> <td>2</td> </tr> <tr> <td>IP addressDEC</td> <td>192.168. 0. 1</td> <td>192.168. 0. 2</td> </tr> <tr> <td></td> <td>MNET/I/O routing information</td> <td>MNET/I/O routing information</td> </tr> <tr> <td></td> <td>FTP Parameters</td> <td>FTP Parameters</td> </tr> <tr> <td></td> <td>Routing information</td> <td>Routing information</td> </tr> </tbody> </table> | | Module No.1 | Module No.2 | Network type | Ethernet | Ethernet | Start I/O No. | 0040 | 0060 | Network No. | 1 | 1 | Total stations | | | Group No. | 0 | 0 | Station No. | 1 | 2 | IP addressDEC | 192.168. 0. 1 | 192.168. 0. 2 | | MNET/I/O routing information | MNET/I/O routing information | | FTP Parameters | FTP Parameters | | Routing information | Routing information |
| | Module No.1 | Module No.2 | | | | | | | | | | | | | | | | | | | | | | | | | | | | | | | | |
| Network type | Ethernet | Ethernet | | | | | | | | | | | | | | | | | | | | | | | | | | | | | | | | |
| Start I/O No. | 0040 | 0060 | | | | | | | | | | | | | | | | | | | | | | | | | | | | | | | | |
| Network No. | 1 | 1 | | | | | | | | | | | | | | | | | | | | | | | | | | | | | | | | |
| Total stations | | | | | | | | | | | | | | | | | | | | | | | | | | | | | | | | | | |
| Group No. | 0 | 0 | | | | | | | | | | | | | | | | | | | | | | | | | | | | | | | | |
| Station No. | 1 | 2 | | | | | | | | | | | | | | | | | | | | | | | | | | | | | | | | |
| IP addressDEC | 192.168. 0. 1 | 192.168. 0. 2 | | | | | | | | | | | | | | | | | | | | | | | | | | | | | | | | |
| | MNET/I/O routing information | MNET/I/O routing information | | | | | | | | | | | | | | | | | | | | | | | | | | | | | | | | |
| | FTP Parameters | FTP Parameters | | | | | | | | | | | | | | | | | | | | | | | | | | | | | | | | |
| | Routing information | Routing information | | | | | | | | | | | | | | | | | | | | | | | | | | | | | | | | |
| IP Address Setting |  | | | | | | | | | | | | | | | | | | | | | | | | | | | | | | | | | |

(4) Setting on the personal computer

Set the IP address.

(5) Communications check

Refer to Section 5.3.1 (5) for communications check.

(6) Settings with GT Designer and GT SoftGOT

- (a) Make the following settings for the QE71 to be monitored in "Ethernet Setting" of GT Designer.

Refer to the Help function of GT Designer for details of Ethernet setting.

| Setting Item | Description |
|--------------|---|
| N/W No. | Set the Network No. assigned to the connected QE71. |
| PLC No. | Set the Station No. assigned to the connected QE71. |
| IP address | Set the IP address assigned to the connected QE71. |
| Port No. | Fixed at "5001". |

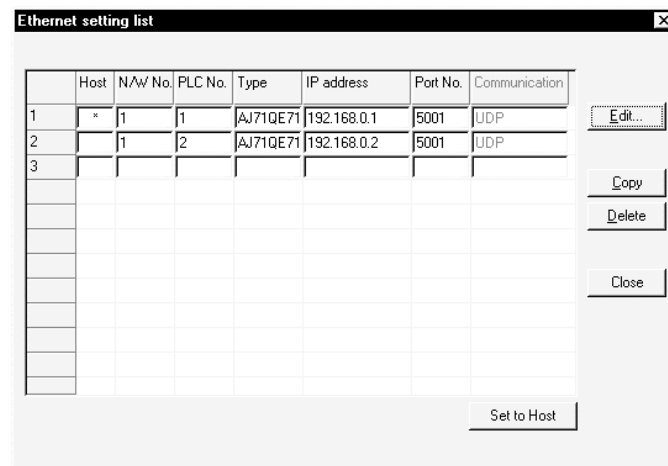

- (b) Define the settings of GT SoftGOT in "Option Setting" of GT SoftGOT. Refer to Section 5.4 for Option setting.

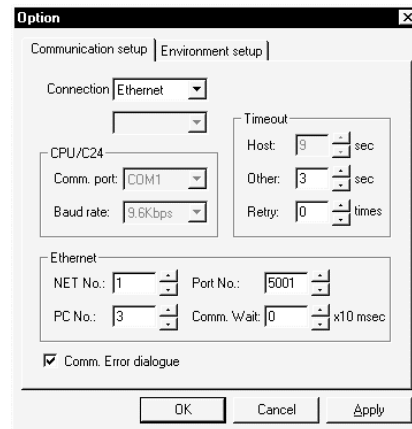

5.3.3 When using Q Series Compatible E71

For communication from GX Developer via the Q-compatible E71, there are the following setting items and precautions. The explanations in this section will be made for the following system configuration.

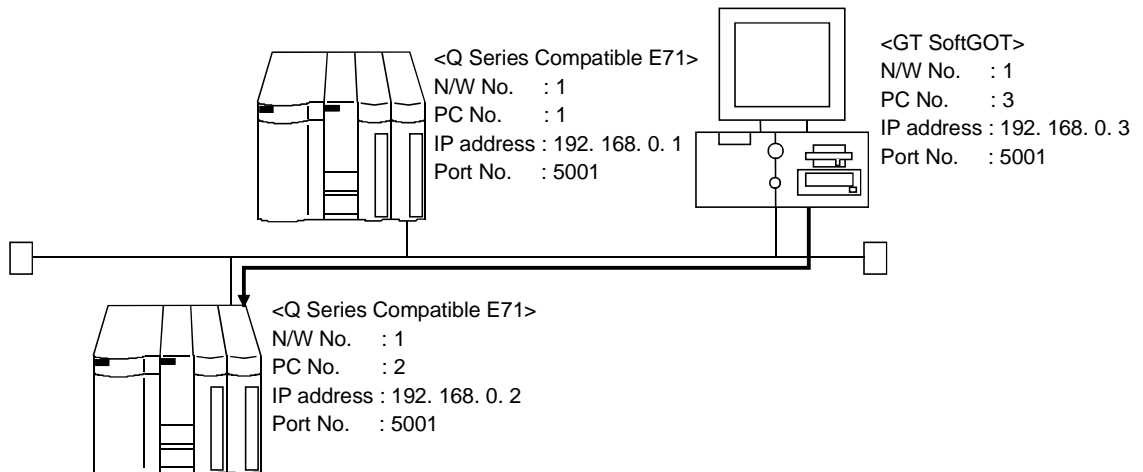
**POINT**

The "port No." specified for Ethernet connection to the Q series-compatible E71 is fixed at "5001".

Refer to item (4) in this section for how to set up the Ethernet unit, network number of GT SoftGOT, personal computer number, IP address, and port number.

Procedure for and restrictions on communications via Q-compatible E71

Restrictions

- (a) Communications cannot be made via the MELSECNET/B, MELSECNET(II), MELSECNET/10.

(1) Compatible models

QJ71E71, QJ71E71-B2, QJ71E71-100

(2) Network parameter setting (Setting with GX Developer)

Parameter setting can be made from the MELSECNET/ETHERNET network parameter setting screen.

Set the network type, first I/O No., network No., group No., station number, mode and operation setting.

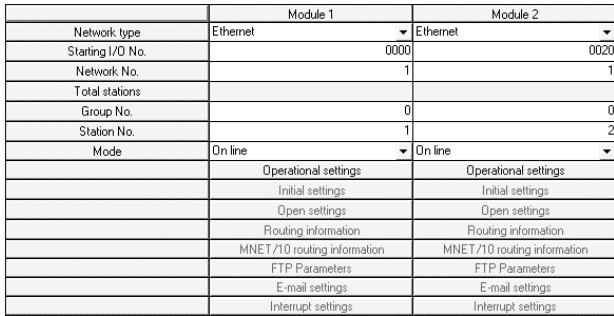
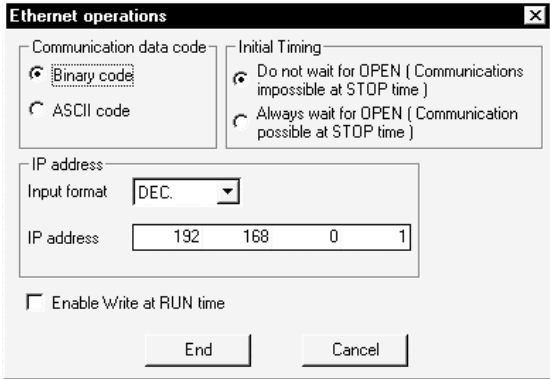
| Item | Setting Screen Examples | | | | | | | | | | | | | | | | | | | | | | | | | | | | | | | | | | | | | | | | | | | | | | | | |
|---------------------|---|-----------------------------|----------|----------|--------------|----------|----------|------------------|------|------|-------------|---|---|----------------|--|--|-----------|---|---|-------------|---|---|------|---------|---------|--|----------------------|----------------------|--|------------------|------------------|--|---------------|---------------|--|---------------------|---------------------|--|-----------------------------|-----------------------------|--|----------------|----------------|--|-----------------|-----------------|--|--------------------|--------------------|
| Ethernet Parameters |  <table border="1"> <thead> <tr> <th></th> <th>Module 1</th> <th>Module 2</th> </tr> </thead> <tbody> <tr> <td>Network type</td> <td>Ethernet</td> <td>Ethernet</td> </tr> <tr> <td>Starting I/O No.</td> <td>0000</td> <td>0020</td> </tr> <tr> <td>Network No.</td> <td>1</td> <td>1</td> </tr> <tr> <td>Total stations</td> <td></td> <td></td> </tr> <tr> <td>Group No.</td> <td>0</td> <td>0</td> </tr> <tr> <td>Station No.</td> <td>1</td> <td>2</td> </tr> <tr> <td>Mode</td> <td>On line</td> <td>On line</td> </tr> <tr> <td></td> <td>Operational settings</td> <td>Operational settings</td> </tr> <tr> <td></td> <td>Initial settings</td> <td>Initial settings</td> </tr> <tr> <td></td> <td>Open settings</td> <td>Open settings</td> </tr> <tr> <td></td> <td>Routing information</td> <td>Routing information</td> </tr> <tr> <td></td> <td>MNET/10 routing information</td> <td>MNET/10 routing information</td> </tr> <tr> <td></td> <td>FTP Parameters</td> <td>FTP Parameters</td> </tr> <tr> <td></td> <td>E-mail settings</td> <td>E-mail settings</td> </tr> <tr> <td></td> <td>Interrupt settings</td> <td>Interrupt settings</td> </tr> </tbody> </table> | | Module 1 | Module 2 | Network type | Ethernet | Ethernet | Starting I/O No. | 0000 | 0020 | Network No. | 1 | 1 | Total stations | | | Group No. | 0 | 0 | Station No. | 1 | 2 | Mode | On line | On line | | Operational settings | Operational settings | | Initial settings | Initial settings | | Open settings | Open settings | | Routing information | Routing information | | MNET/10 routing information | MNET/10 routing information | | FTP Parameters | FTP Parameters | | E-mail settings | E-mail settings | | Interrupt settings | Interrupt settings |
| | Module 1 | Module 2 | | | | | | | | | | | | | | | | | | | | | | | | | | | | | | | | | | | | | | | | | | | | | | | |
| Network type | Ethernet | Ethernet | | | | | | | | | | | | | | | | | | | | | | | | | | | | | | | | | | | | | | | | | | | | | | | |
| Starting I/O No. | 0000 | 0020 | | | | | | | | | | | | | | | | | | | | | | | | | | | | | | | | | | | | | | | | | | | | | | | |
| Network No. | 1 | 1 | | | | | | | | | | | | | | | | | | | | | | | | | | | | | | | | | | | | | | | | | | | | | | | |
| Total stations | | | | | | | | | | | | | | | | | | | | | | | | | | | | | | | | | | | | | | | | | | | | | | | | | |
| Group No. | 0 | 0 | | | | | | | | | | | | | | | | | | | | | | | | | | | | | | | | | | | | | | | | | | | | | | | |
| Station No. | 1 | 2 | | | | | | | | | | | | | | | | | | | | | | | | | | | | | | | | | | | | | | | | | | | | | | | |
| Mode | On line | On line | | | | | | | | | | | | | | | | | | | | | | | | | | | | | | | | | | | | | | | | | | | | | | | |
| | Operational settings | Operational settings | | | | | | | | | | | | | | | | | | | | | | | | | | | | | | | | | | | | | | | | | | | | | | | |
| | Initial settings | Initial settings | | | | | | | | | | | | | | | | | | | | | | | | | | | | | | | | | | | | | | | | | | | | | | | |
| | Open settings | Open settings | | | | | | | | | | | | | | | | | | | | | | | | | | | | | | | | | | | | | | | | | | | | | | | |
| | Routing information | Routing information | | | | | | | | | | | | | | | | | | | | | | | | | | | | | | | | | | | | | | | | | | | | | | | |
| | MNET/10 routing information | MNET/10 routing information | | | | | | | | | | | | | | | | | | | | | | | | | | | | | | | | | | | | | | | | | | | | | | | |
| | FTP Parameters | FTP Parameters | | | | | | | | | | | | | | | | | | | | | | | | | | | | | | | | | | | | | | | | | | | | | | | |
| | E-mail settings | E-mail settings | | | | | | | | | | | | | | | | | | | | | | | | | | | | | | | | | | | | | | | | | | | | | | | |
| | Interrupt settings | Interrupt settings | | | | | | | | | | | | | | | | | | | | | | | | | | | | | | | | | | | | | | | | | | | | | | | |
| Operation Setting |  <p>Ethernet operations</p> <p>Communication data code: <input checked="" type="radio"/> Binary code, <input type="radio"/> ASCII code</p> <p>Initial Timing: <input checked="" type="radio"/> Do not wait for OPEN (Communications impossible at STOP time), <input type="radio"/> Always wait for OPEN (Communication possible at STOP time)</p> <p>IP address: Input format DEC, IP address 192 168 0 1</p> <p><input type="checkbox"/> Enable Write at RUN time</p> <p>End Cancel</p> | | | | | | | | | | | | | | | | | | | | | | | | | | | | | | | | | | | | | | | | | | | | | | | | |

*: Operation settings

To make communications with GX Developer, ask the person in charge of the network about the IP address setting to confirm, and set the IP address.

Since "any" values may be set to the other items, set them according to the specifications of the other node and application connected to the Q series-compatible E71.

The following are the operation setting items that may be set to "any" values on GX Developer.

(1) Communication data code

Either "Binary code" or "ASCII code" may be specified.

(2) Initial Timing

Independently of this setting, communications can be made from GX Developer if the PLC CPU is at a STOP.

(3) Enable Write at RUN time

Independently of this setting, online program correction or device test can be performed from GX Developer.

- (4) Setting on the personal computer
Set the IP address.
- (5) Communications check
Refer to Section 5.3.1 (5) for communications check.
- (6) Settings with GT Designer and GT SoftGOT
 - (a) Make the following settings for the Q series-compatible E71 to be monitored in "Ethernet Setting" of GT Designer.
Refer to the Help function of GT Designer for details of Ethernet setting.

| Setting Item | Description |
|--------------|--|
| N/W No. | Set the Network No. assigned to the connected Q series-compatible E71. |
| PLC No. | Set the Station No. assigned to the connected Q series-compatible E71. |
| IP address | Set the IP address assigned to the connected Q series-compatible E71. |
| Port No. | Fixed at "5001". |

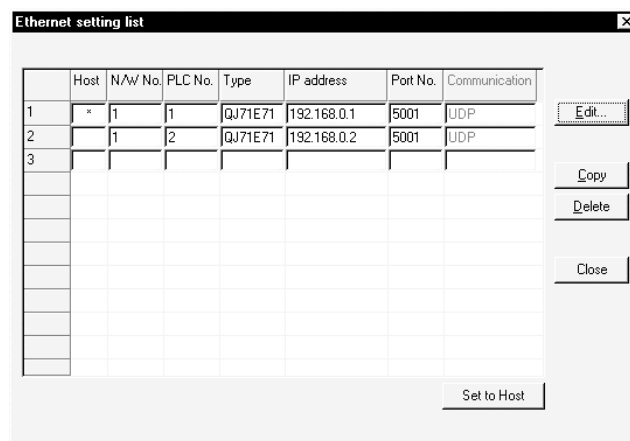

- (b) Define the settings of GT SoftGOT in "Option Setting" of GT SoftGOT.
Refer to Section 5.4 for Option setting.

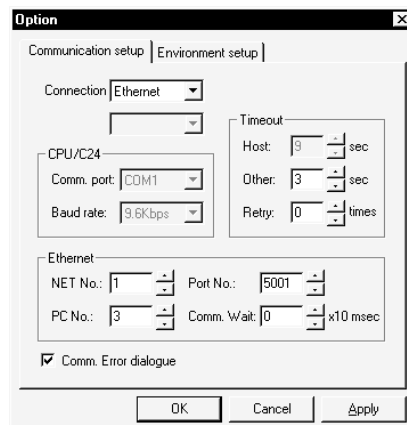

5.3.4 How to Set Devices Using GT Designer

The following explains how to set devices defined with GT Designer when connected via Ethernet.

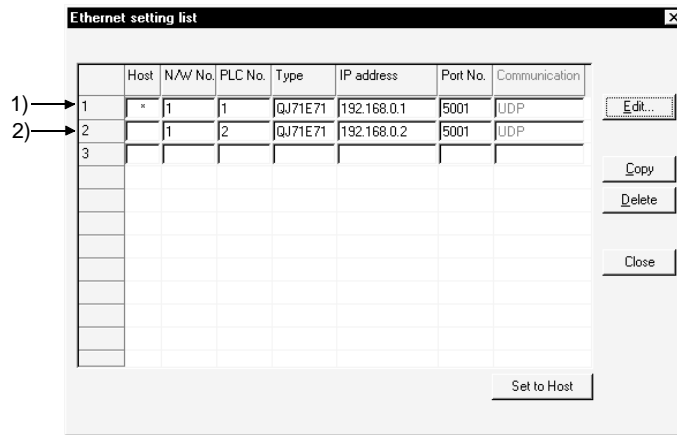

- (1) If Ethernet unit 1) (an Ethernet unit set as local station) is monitored by GT SoftGOT, set the network setting to the local station when the device is set with GT Designer.

<Setting example with GT Designer>

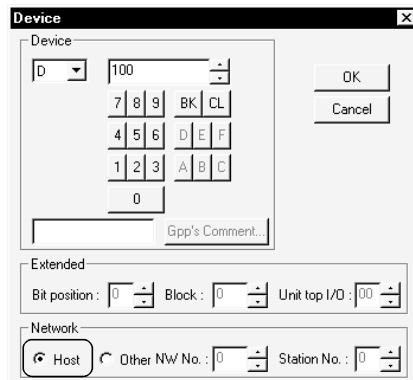

- (2) If Ethernet unit 2) (an Ethernet unit that is not set as local station) is monitored by GT SoftGOT, set the network setting to other station (network No. "1", personal computer station No. "2") when the device is set with GT Designer.

<Setting example with GT Designer>

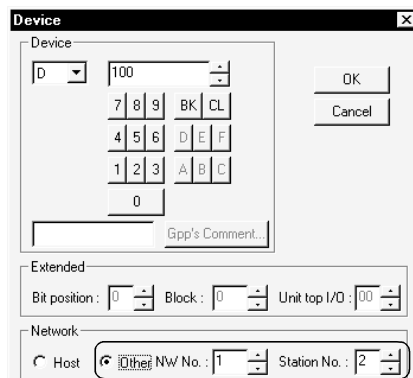

5.4 How to set up the Computer link connection

When connecting the GOT and the computer link unit and serial communication unit and modem interface unit for monitoring, set the switches of the computer link unit and serial communication unit as follows.

5.4.1 When using A Series

(1) When connecting with an AJ71C24-S8

The following shows the settings when connecting with an AJ71C24-S8.

| Switch | Baud rate (Transmission speed) | |
|-----------------------|--------------------------------|----------|
| | 9600bps | 19200bps |
| Station number switch | 0 | |
| Mode switch | 1 | |
| SW11 | OFF | |
| SW12 | ON | |
| SW13 | ON | OFF |
| SW14 | OFF | ON |
| SW15 | ON | ON |
| SW16 | ON | |
| SW17 | OFF | |
| SW18 | OFF | |
| SW21 | ON | |
| SW22 | ON | |
| SW23 | OFF | |
| SW24 | OFF | |

(2) When connecting with an AJ71UC24

The following shows the settings when connecting with an AJ71UC24.

| Switch | Baud rate (Transmission speed) | |
|-----------------------|--------------------------------|----------|
| | 9600bps | 19200bps |
| Station number switch | 0 | |
| Mode switch | 1 | |
| SW11 | OFF | |
| SW12 | ON | |
| SW13 | ON | OFF |
| SW14 | OFF | ON |
| SW15 | ON | ON |
| SW16 | ON | |
| SW17 | OFF | |
| SW18 | OFF | |
| SW21 | ON | |
| SW22 | ON | |
| SW23 | ON | |
| SW24 | OFF | |

(3) When connecting with an A1SJ71UC24-R2 and A1SJ71C24-R2.

The following shows the settings when connecting with an A1SJ71UC24-R2 and A1SJ71C24-R2.

| Switch | Baud rate (Transmission speed) | |
|-----------------------|--------------------------------|----------|
| | 9600bps | 19200bps |
| Station number switch | No applicable switch | |
| Mode switch | 1 | |
| SW01 | No applicable switch | |
| SW02 | No applicable switch | |
| SW03 | OFF | |
| SW04 | ON | |
| SW05 | ON | OFF |
| SW06 | OFF | ON |
| SW07 | OFF | ON |
| SW08 | ON | |
| SW09 | ON | |
| SW10 | OFF | |
| SW11 | OFF | |
| SW12 | ON | |

5.4.2 When using QnA Series

The following shows the settings when connecting with a QnA series (AJ71QC24(-R2), AJ71QC24N(-R2), A1SJ71QC24(-R2) and A1SJ71QC24N(-R2)).

| Switch | Baud rate (Transmission speed) | | | | |
|-----------------------|--------------------------------|----------|----------|----------|-----------|
| | 9600bps | 19200bps | 38400bps | 57600bps | 115200bps |
| Station number switch | 0 | | | | |
| Mode switch | 5 | | | | |
| SW01 | OFF | | | | |
| SW02 | ON | | | | |
| SW03 | ON | | | | |
| SW04 | OFF | | | | |
| SW05 | OFF | | | | |
| SW06 | ON | | | | |
| SW07 | ON | | | | |
| SW08 | OFF | | | | |
| SW09 | ON | OFF | ON | OFF | ON |
| SW10 | OFF | ON | ON | ON | ON |
| SW11 | ON | ON | ON | OFF | OFF |
| SW12 | OFF | OFF | OFF | ON | ON |

* 38400 bps, 57600 bps and 115200 bps can be set only for the following units.

- AJ71QC24N (-R2)
- A1SJ71QC24N (-R2)

5.4.3 When using Q Series

Use I/O assignment setting of GX Developer to set the QJ71C24(-R2) switches. For details of the setting method, refer to GX Developer Operating Manual. Settings depend on the channel (interface number) of the unit to which the GT SoftGOT is connected. Set the switches as indicated below according to the channel where the GT SoftGOT is connected. However, when the GT SoftGOT is connected with the QJ71CMO, only CH2 is usable.

| Channel Where GT SoftGOT Is Connected | Settings | | | | | | | | | | | | | | | | | | | | | | | | | | | | | | | | | | | | | | | | | | | | | | | | | | |
|---------------------------------------|--|----------|--------------|----------|------------|----------|----------|----------|----------|----------|---|---|-----|-----|--|--|--|--|--|--|--|---|--------|----------|--------------|------|------|------|------|------|--|---|--------|--|--|--|--|--|--|--|--|---|--------|--|--|--|--|--|--|--|--|
| CH1 | <div style="border: 1px solid black; padding: 5px;"> <p>Switch setting for I/O and intelligent functional module</p> <p style="text-align: right;">Input format <input style="width: 50px;" type="text" value="HEX."/></p> <table border="1" style="width: 100%; border-collapse: collapse;"> <thead> <tr> <th></th> <th>Slot</th> <th>Type</th> <th>Model name</th> <th>Switch 1</th> <th>Switch 2</th> <th>Switch 3</th> <th>Switch 4</th> <th>Switch 5</th> <th>▲</th> </tr> </thead> <tbody> <tr> <td>0</td> <td>PLC</td> <td>PLC</td> <td></td> <td></td> <td></td> <td></td> <td></td> <td></td> <td></td> </tr> <tr> <td>1</td> <td>0[*-0]</td> <td>Intelli.</td> <td>QJ71C24(-R2)</td> <td>0000</td> <td>0000</td> <td></td> <td></td> <td>0000</td> <td></td> </tr> <tr> <td>2</td> <td>1[*-1]</td> <td></td> <td></td> <td></td> <td></td> <td></td> <td></td> <td></td> <td></td> </tr> <tr> <td>3</td> <td>2[*-2]</td> <td></td> <td></td> <td></td> <td></td> <td></td> <td></td> <td></td> <td></td> </tr> </tbody> </table> </div> | | Slot | Type | Model name | Switch 1 | Switch 2 | Switch 3 | Switch 4 | Switch 5 | ▲ | 0 | PLC | PLC | | | | | | | | 1 | 0[*-0] | Intelli. | QJ71C24(-R2) | 0000 | 0000 | | | 0000 | | 2 | 1[*-1] | | | | | | | | | 3 | 2[*-2] | | | | | | | | |
| | Slot | Type | Model name | Switch 1 | Switch 2 | Switch 3 | Switch 4 | Switch 5 | ▲ | | | | | | | | | | | | | | | | | | | | | | | | | | | | | | | | | | | | | | | | | | |
| 0 | PLC | PLC | | | | | | | | | | | | | | | | | | | | | | | | | | | | | | | | | | | | | | | | | | | | | | | | | |
| 1 | 0[*-0] | Intelli. | QJ71C24(-R2) | 0000 | 0000 | | | 0000 | | | | | | | | | | | | | | | | | | | | | | | | | | | | | | | | | | | | | | | | | | | |
| 2 | 1[*-1] | | | | | | | | | | | | | | | | | | | | | | | | | | | | | | | | | | | | | | | | | | | | | | | | | | |
| 3 | 2[*-2] | | | | | | | | | | | | | | | | | | | | | | | | | | | | | | | | | | | | | | | | | | | | | | | | | | |
| CH2 | <div style="border: 1px solid black; padding: 5px;"> <p>Switch setting for I/O and intelligent functional module</p> <p style="text-align: right;">Input format <input style="width: 50px;" type="text" value="HEX."/></p> <table border="1" style="width: 100%; border-collapse: collapse;"> <thead> <tr> <th></th> <th>Slot</th> <th>Type</th> <th>Model name</th> <th>Switch 1</th> <th>Switch 2</th> <th>Switch 3</th> <th>Switch 4</th> <th>Switch 5</th> <th>▲</th> </tr> </thead> <tbody> <tr> <td>0</td> <td>PLC</td> <td>PLC</td> <td></td> <td></td> <td></td> <td></td> <td></td> <td></td> <td></td> </tr> <tr> <td>1</td> <td>0[*-0]</td> <td>Intelli.</td> <td>QJ71C24(-R2)</td> <td></td> <td></td> <td>0000</td> <td>0000</td> <td>0000</td> <td></td> </tr> <tr> <td>2</td> <td>1[*-1]</td> <td></td> <td></td> <td></td> <td></td> <td></td> <td></td> <td></td> <td></td> </tr> <tr> <td>3</td> <td>2[*-2]</td> <td></td> <td></td> <td></td> <td></td> <td></td> <td></td> <td></td> <td></td> </tr> </tbody> </table> </div> | | Slot | Type | Model name | Switch 1 | Switch 2 | Switch 3 | Switch 4 | Switch 5 | ▲ | 0 | PLC | PLC | | | | | | | | 1 | 0[*-0] | Intelli. | QJ71C24(-R2) | | | 0000 | 0000 | 0000 | | 2 | 1[*-1] | | | | | | | | | 3 | 2[*-2] | | | | | | | | |
| | Slot | Type | Model name | Switch 1 | Switch 2 | Switch 3 | Switch 4 | Switch 5 | ▲ | | | | | | | | | | | | | | | | | | | | | | | | | | | | | | | | | | | | | | | | | | |
| 0 | PLC | PLC | | | | | | | | | | | | | | | | | | | | | | | | | | | | | | | | | | | | | | | | | | | | | | | | | |
| 1 | 0[*-0] | Intelli. | QJ71C24(-R2) | | | 0000 | 0000 | 0000 | | | | | | | | | | | | | | | | | | | | | | | | | | | | | | | | | | | | | | | | | | | |
| 2 | 1[*-1] | | | | | | | | | | | | | | | | | | | | | | | | | | | | | | | | | | | | | | | | | | | | | | | | | | |
| 3 | 2[*-2] | | | | | | | | | | | | | | | | | | | | | | | | | | | | | | | | | | | | | | | | | | | | | | | | | | |

POINT

When using the GT SoftGOT connected to the serial communication unit of function version B, you can use CH1 and CH2 of the serial communication unit together. Hence, you can use the GT SoftGOT and GX Developer or similar peripheral device or two GT SoftGOTs connected to one serial communication unit. Note that the above connections cannot be made on the serial communication unit of function version A.

5.4.4 Transmission specifications

The following transmission specifications apply to the case where communication is made between the GT SoftGOT and computer link or serial communication module.

| Item | Settings | | | |
|--------------------|--|-------------------------------------|-----------------------------------|---|
| | Q Series | QnA Series | | A Series |
| | QJ71C24(-R2)
QJ71CMO | AJ71QC24N(-R2),
A1SJ71QC24N(-R2) | AJ71QC24(-R2),
A1SJ71QC24(-R2) | AJ71C24-S8, AJ71UC24
A1SJ71UC24-R2, A1SJ71C24-R2 |
| Transmission speed | 9600bps/19200bps/38400bps/57600bps/115200bps | | 9600bps/19200bps | |
| Data length | 8 bits | | | |
| Stop bit | 1 bits | | | |
| Parity bit | Yes (odd) | | | |
| Sum check | Yes | | | |

5.5 Option Setting

In Option Setting, it is possible to set the type of the PLC CPU to be connected to and the screen size to be monitored (resolution), etc.

POINT
 Make option setting before starting monitor.
 After start of monitor on GT SoftGOT, option setting cannot be made.

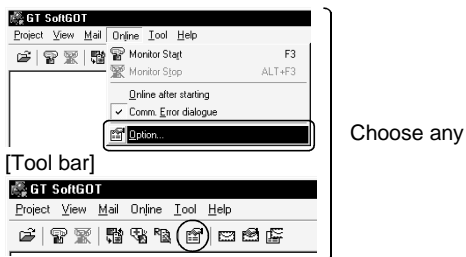

- 1) When making option setting, choose any of the following.
 - "Online" - "Option"
 - "Option" on toolbar
 - "Option" by right-clicking the mouse
 (Refer to Section 4.2 for right-clicking the mouse)

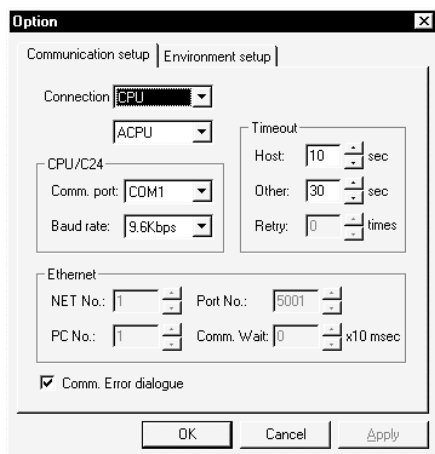

- 2) As the Option setting dialog box appears, make settings. (Refer to Section 5.5.1.)
 After setting, press to update the information.
 Clicking the button closes the dialog box.

5.5.1 Option Setting Dialog Box

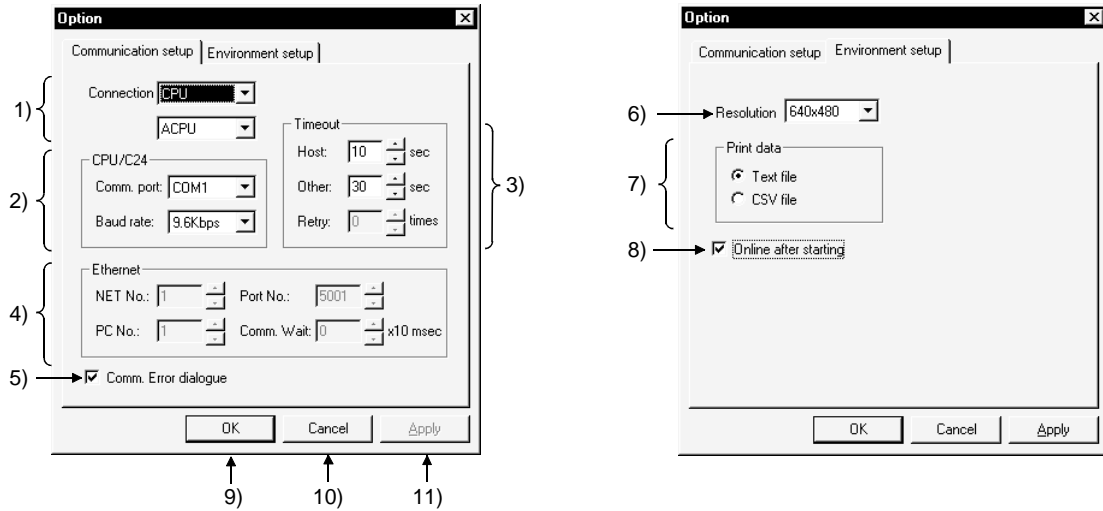

| Number | Item | Description |
|--------|-----------------|--|
| 1) | Connection | Select the connection method of GT SoftGOT.
"CPU" : Select this option when direct connection to CPU is used.
"C24" : Select this option when computer link connection is used.
"NET/H" : Select this when using the MELSECNET/H board.
(Also select "NET/H" when using the MELSECNET/H board in the NET/10 mode.)
"NET/10" : Select this when using the MELSECNET/10 board.
"Ethernet" : Select this option when Ethernet connection is used.
"Q-BUS" : Select this option when Q bus connection is used. (May be set only when the PC CPU module is used.)
(The default is "CPU".) |
| | — | If "CPU"/"C24"/"NET/H"/"NET/10" is selected as the connection method, designate the connection destination.
When "CPU" is selected: Selects the type of CPU to be connected.
When "C24" is selected: Selects the type of computer link unit or serial communication unit to be connected.
When "NET/H" or "NET/10" is selected: select the board to be used (board mounted to the personal computer). |
| 2) | CPU/C24 | When you selected "CPU"/"C24" in the connection method, the following items are set. |
| | Comm. port | Choose the communication port on the personal computer side.
"COM1" to "COM6" (The default is "COM1".) |
| 3) | Baud rate | Set the transmission speed to/from the CPU.
Set the baud rate to be used.
When connecting a QnA/A series computer link, set the same baud rate as the one set in the computer link/serial communication unit to be used. |
| | Timeout | Set the timeout period and retry count. |
| | Host * | Set the timeout period for host monitor.
"3" to "90" (seconds) |
| | Other station * | Set the timeout period for other station monitor.
"3" to "90" (seconds) |
| | Retry * | Set the number of retries.
"0" to "10" (times) |

* GT SoftGOT operates even with the default settings.

| Number | Item | Description |
|--------|-----------------------|--|
| 4) | Ethernet | When you selected "Ethernet" in the connection method, the following items are set. |
| | NET No. * | Set the network number of GT SoftGOT.
"1" to "239" (The default is "1.") |
| | PC No. | Set the station number of GT SoftGOT.
The station number must be different from the personal computers personal computer number of the Ethernet unit to be monitored. "1" to "64" (The default is "1.") |
| | Port No. * | Set the port number of GT SoftGOT.
"1024" to "65535" (The default is "5001.") |
| | Comm. Wait * | Set the transmission wait time in order to reduce the load on the network and target PLC.
"0" to "10000" (x 10 ms) (The default is "0.") |
| 5) | Comm. Error dialogue | Enable this check box to display the error dialogue box in GT SoftGOT when a communication error occurred.
(The check box is enabled by default.) |
| 6) | Resolution | Select the screen size (resolution: dots) to be monitored.
"640 x 480," "800 x 600," "1024 x 768," "1280 x 1024"
(The default is "640 x 480.") |
| 7) | Print data | Select the format of the data saved in the "Memcard" folder in the alarm history function, etc.
(The default is "Text file.") |
| | Text file | Saves data in text file format. |
| | CSV file | Saves data in CSV file format. |
| 8) | Online after starting | Enable this check box if it is desired to start up GT SoftGOT in online mode. If this check box is enabled, GT SoftGOT starts up in online mode from the next time.
(The check box is disabled by default.) |
| 9) | OK | Used to update the settings and close the dialog box. |
| 10) | Cancel | Used to cancel the settings and close the dialog box. |
| 11) | Apply | Used to update the settings. |

* GT SoftGOT operates even with the default settings.

5.6 Execution of monitor

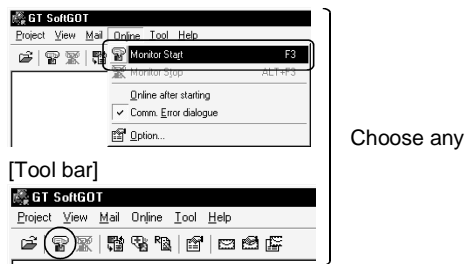

- 1) To start monitor, choose any of the following.
 - "Online" - "Monitor start"
 - "Start of Monitoring" on toolbar
 - "Monitor start" by right-clicking the mouse
(Refer to Section 4.2 for right-clicking the mouse)



- 2) Monitor of the project monitored previously starts.

POINT

- When monitor is performed for the first time on GT SoftGOT, choosing "Start" causes GT SoftGOT to show the utility screen.
In this case, choose "Open" (refer to Section 5.7) and read the monitor data to start monitor.
For details of the utility function, refer to the GOT-A900 Series Operating Manual (GT Works Version5/GT Designer Version5 compatible Extended • Option Functions Manual)

5.7 Opening the Project

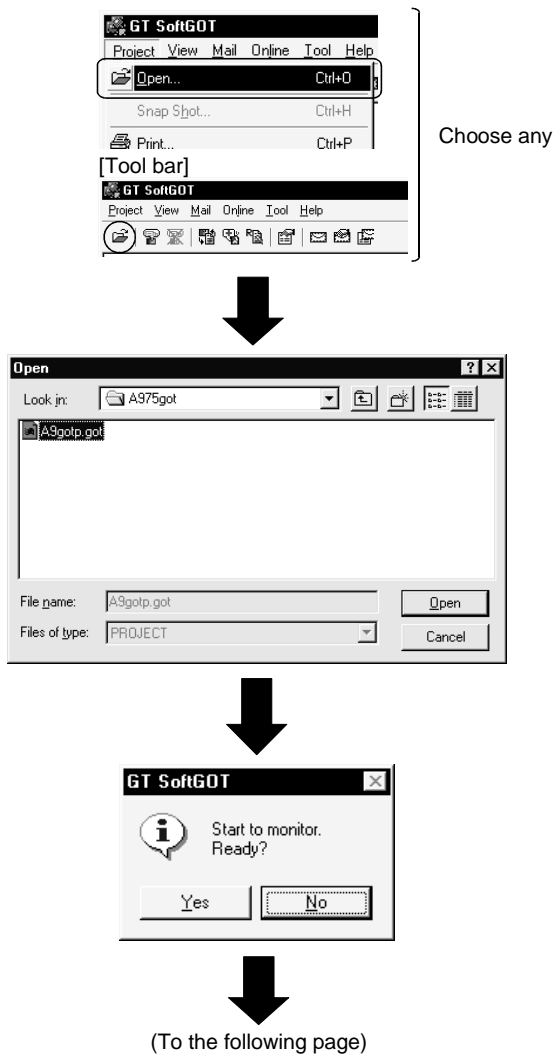

- 1) To open a project, choose any of the following.
 - "Project" - "Open"
 - "Open project" on toolbar
 - "Open" by right-clicking the mouse
 (Refer to Section 4.2 for right-clicking the mouse)

- 2) Choose the project where the monitor data created on GT Designer is stored.

- 3) The left dialog box appears.
 (The dialogue box is not displayed if GT SoftGOT is already in online mode.)
 Select Yes No to start monitoring the project monitored previously.
 (Display the Utility screen in order to open a project for the first time.)

Turn the power supply to the PLC off or disconnect the communication cable that connects the personal computer and PLC in advance if it is not desired to go into online mode with the previous monitor data or if it is desired to open a project in off-line mode.

(From the previous page)

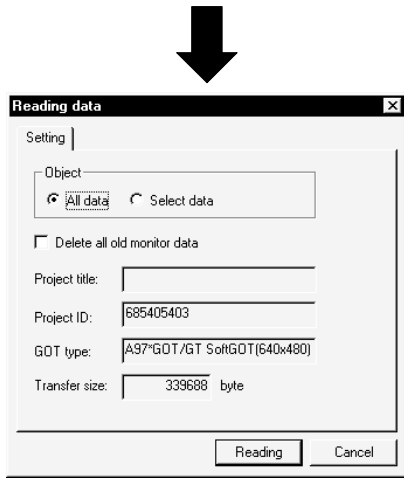

- 4) As the "Reading data" dialog box appears, make settings. (Refer to Section 5.7.1)
Choosing reads the monitor data of the selected project.

Go to step 5) if the power supply to the PLC is turned off or the communication cable is disconnected in step 3).
Otherwise, go to step 6).

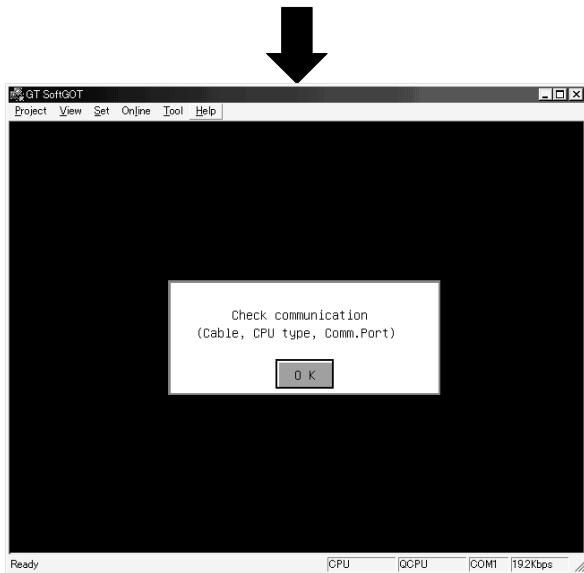

- 5) The message shown to the left is displayed. Turn the power supply to the PLC on or connect the communication cable, and then select .

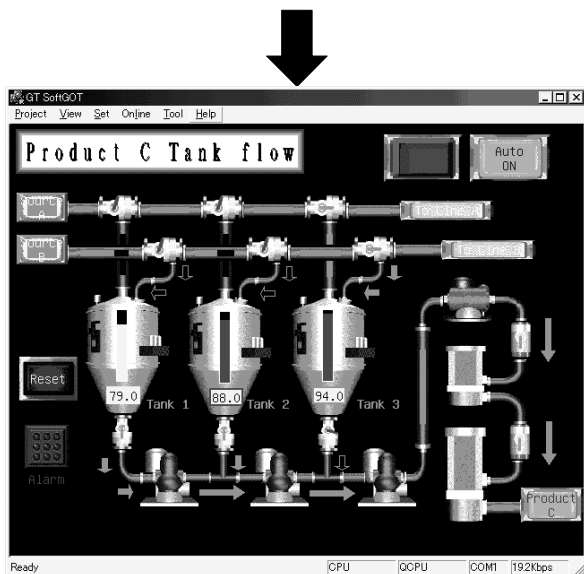

- 6) The monitoring of the selected project starts.

5.7.1 Description of the monitor data reading dialog box

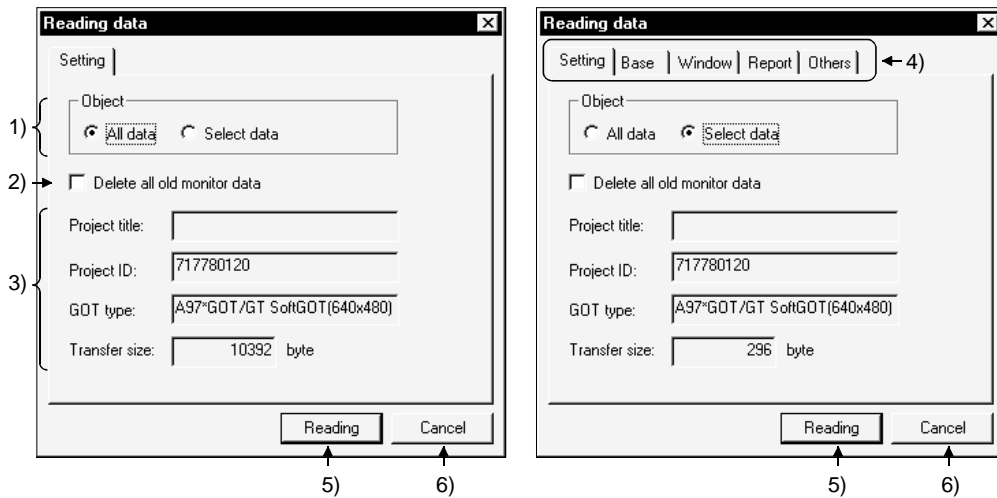

| Number | Item | Description |
|--------|---|---|
| 1) | Object | "All data"
Check when reading all monitor data of the selected project.
"Select data"
Check when reading some monitor data of the selected project. |
| 2) | Delete all old monitor data | Turn on the check box when reading the monitor data of the selected project after deletion of the already read monitor data. |
| 3) | Project title
Project ID
GOT type
Trans size | The settings and data size of the monitor data to be read appear. |
| 4) | "Base"
"Window"
"Others"
Tab | Turn on the read data check boxes when you chose "Select data" in Object.
"Base"/"Window" tab
Turn on the screen number and screen title check boxes of the screen to be read.
"Others" tab
Turn on the read data (part data, comment, common settings, high-quality font, sound WAVE) check boxes.
Common settings are always read. |
| 5) | Reading | Used to read the monitor data of the selected project. |
| 6) | Cancel | Used to cancel reading the monitor data of the selected project. |

5.8 Operation at Monitoring

On GT SoftGOT, touching the touch keys is performed by pressing the mouse button. Touching is indicated by "beep".

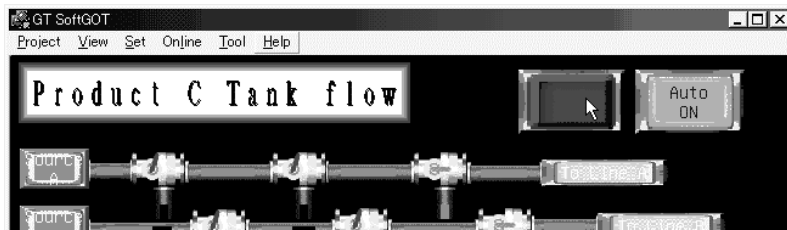

POINT
 When the sound card is fitted, the sound set in "Default sound" after choosing "Control Panel"->"Sounds" beeps on Windows® 98, Windows® Me.

5.9 Stopping Monitoring

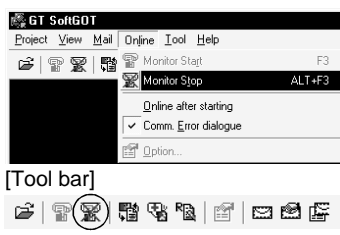

Choose any

- 4) To stop monitoring, choose any of the following:
 - "Online" - "Monitor stop"
 - "End of monitoring" on toolbar
 - "Monitor Stop" by right-clicking the mouse (Refer to Section 4.2 for right-clicking the mouse)

5.10 Exiting from GT SoftGOT



Choose any

- 1) To exit from GT SoftGOT, choose any of the following.
 - "Project" - "GT SoftGOT Exit"
 - "Close" in system menu
 - "GT SoftGOT Exit" by right-clicking the mouse (Refer to Section 4.2 for right-clicking the mouse)

5.11 Automatic Startup

The following explains how to start up GT SoftGOT automatically when Windows® is started up by using "Online after starting."

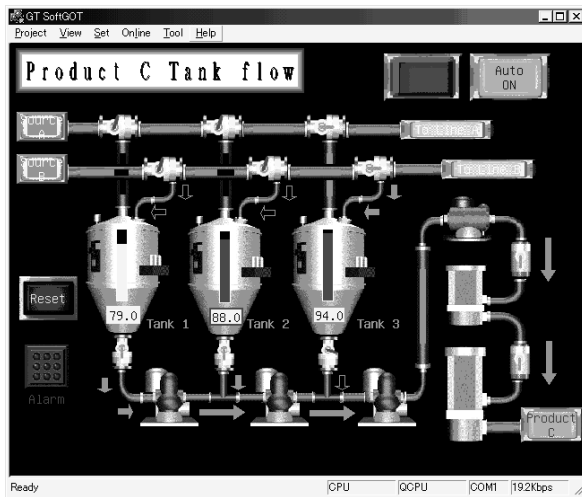

- 1) After starting up GT SoftGOT, the monitor data for which the monitoring should be automatically started up is read and monitored by GT SoftGOT.

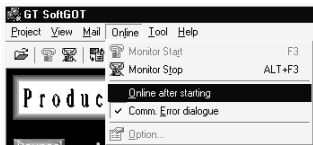

- 2) Choose any of the following.
 - "Online" - "Online after Starting."
 - Online after starting by right-clicking the mouse.
(Refer to Section 4.2 for right-clicking the mouse)

- 3) Close GT SoftGOT.

[Example of Windows® 98 screen]

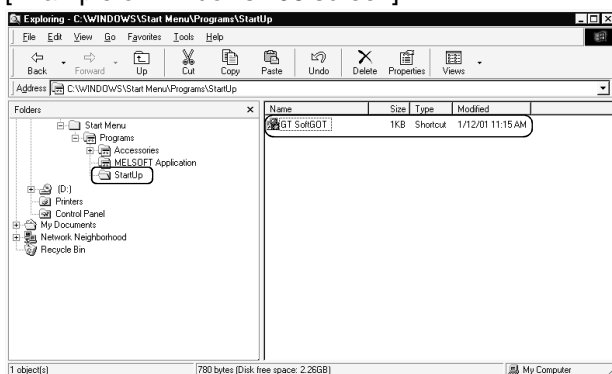

- 4) Start up Windows Explorer and copy the GT SoftGOT icon in "MELSOFT application" to "Startup" in Windows.
- 5) GT SoftGOT automatically starts up when Windows® is started up from the next time, and automatically begins monitoring.

POINT
 Make sure that the power supply to the connected PLC CPU is turned on before starting up Windows® when performing automatic startup.

Chapter 6 FUNCTIONS OF GT SOFTGOT

6.1 Snap Shot Function

The snap shot function allows a screen image being monitored on GT SoftGOT to be saved into any folder as a BMP format file.

6.1.1 Operating procedure



- 1) Select "Project" - "Snap Shot" during GT SoftGOT monitoring.

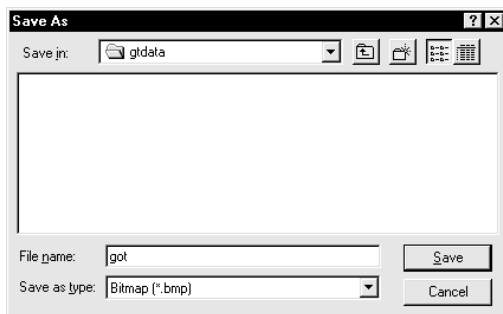

- 2) Choose the folder which will save the data. After setting the file name, press to save the screen image of GT Simulator in BMP format.

6.2 Print Function

The print function allows a screen image being monitored on GT SoftGOT to be output to a printer.

6.2.1 Operating procedure

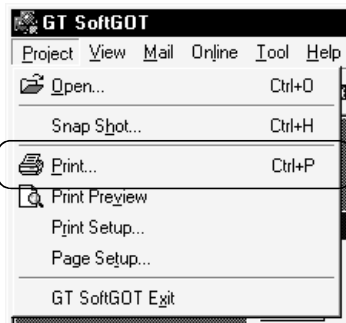

- 1) Select "Project" - "Print" during GT SoftGOT monitoring to start printing.
Note that printing cannot be done if the printer is not specified.

6.2.2 Print preview

Selecting Print preview shows a printing image.

6.2.3 Page setup

Selecting Page setup shows the following dialog box.

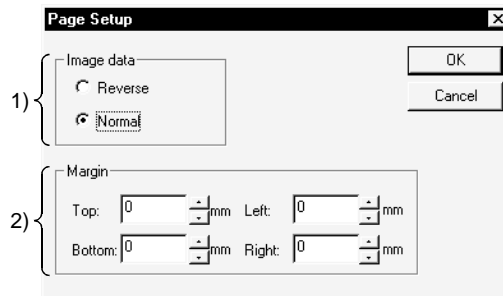

| Number | Item | Description |
|--------|------------|---|
| 1) | Image data | Choose "Reverse" to print the screen in reverse video.
(Defaults to "Normal".) |
| 2) | Margin | Set the margins on a page to be printed.
When margins have been set, the screen to be printed is reduced according to the specified values.
The reduction image of the screen can also be checked in Print preview. |

6.3 Data Reference Function

It is possible to reference data of the following object functions stored on the hard disk of the personal computer:

- Recipe function..... References recipe data stored as CSV format files.
- Alarm history display function References print image data of alarm history stored as text format files or as CSV format files.
- Report function References print image data of reports stored as text format files or as CSV format files.
- Hardcopy function References screen image data stored as BMP format files.

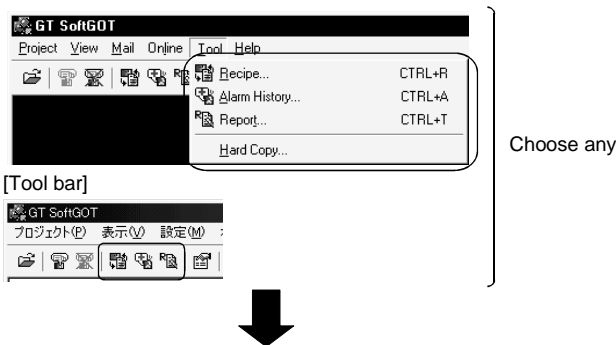

- 1) Choose any of the following.
 - "Tool" - "Recipe/Alarm History/Report/Hard Copy"
 - Click the corresponding button on the tool bar. (Only for Recipe, Alarm History, and Report)
 - "Tool" - "Recipe/Alarm History/Report/Hard Copy" by right-clicking the mouse. (Refer to Section 4.2 for right-clicking the mouse)

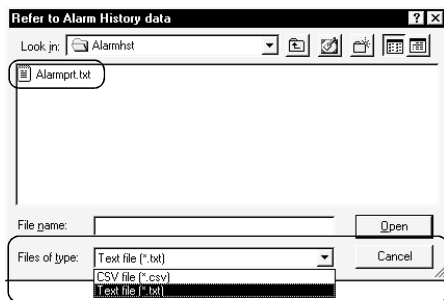

- 2) Select a file to be referenced. Select the type of file to be referenced for reference alarm history data or report data.

POINT

- Data cannot be updated while being referenced. (The data is held during this time.)
(The held data is reflected when the print data is updated after the data reference is over.)
- Use the format shown in Example 1 if tables are created in the alarm history display function or report function.
Tables with the format shown in Example 2 cannot be properly displayed in CSV files.

(Example 1) Table created with GT Designer CSV file table

| | | |
|---|---|---|
| | A | B |
| X | 1 | 2 |
| Y | 3 | 4 |

➔

| | | |
|---|---|---|
| | A | B |
| X | 1 | 2 |
| Y | 3 | 4 |

(Example 2) Table created with GT Designer CSV file table

| | | |
|---|---|---|
| | A | B |
| X | 1 | 2 |
| Y | 3 | 4 |

➔

| | | |
|---|---|---|
| A | B | |
| X | 1 | 2 |
| Y | 3 | 4 |

6.4 Mail Function

| POINT |
|---|
| <ul style="list-style-type: none"> • If the mail function is used, e-mail is sent from GT SoftGOT, so mail software is not required on the sending side. • In order to use the mail function, it is necessary to make a contract with a service provider and set up the environment so that e-mail can be sent. |

6.4.1 Mail function overview

It is possible to send messages from GT SoftGOT to personal computers and mobile phones.

The mail function can only be used in the following object functions:

- Alarm history display function
- Time action function

(1) Using the alarm history display function

It is possible to send error and recovery information at error/recovery of stations using the alarm history display function.

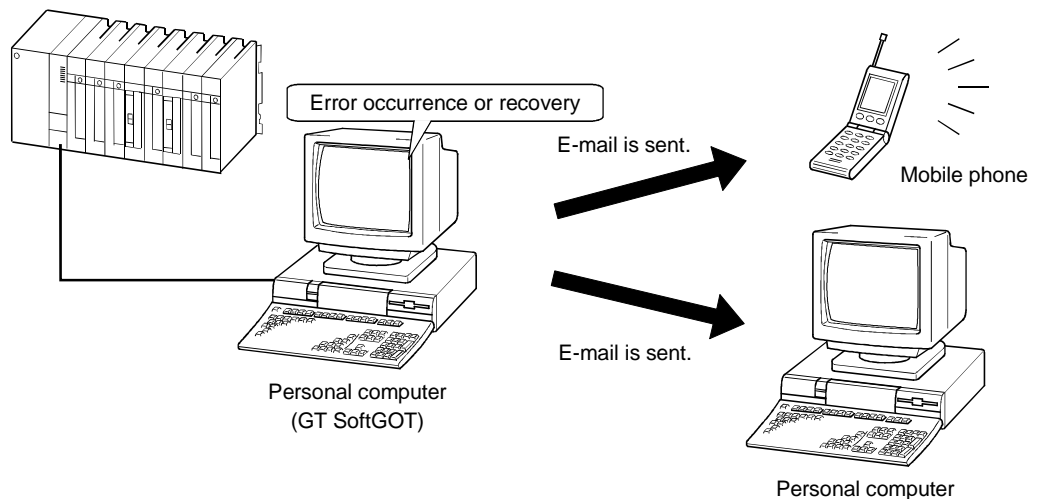

(2) Using the time action function

It is possible to send alarm history data, recipe data, and screen images stored in "Memcard" at the specified date and time using the time action function.

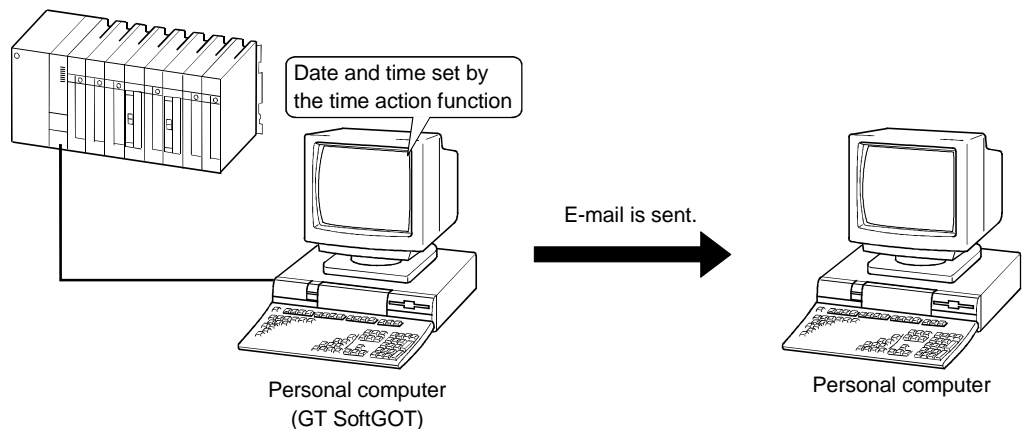

6.4.2 Operation flow when using the mail function

The following flowchart shows operations involved in using the mail function of GT SoftGOT.

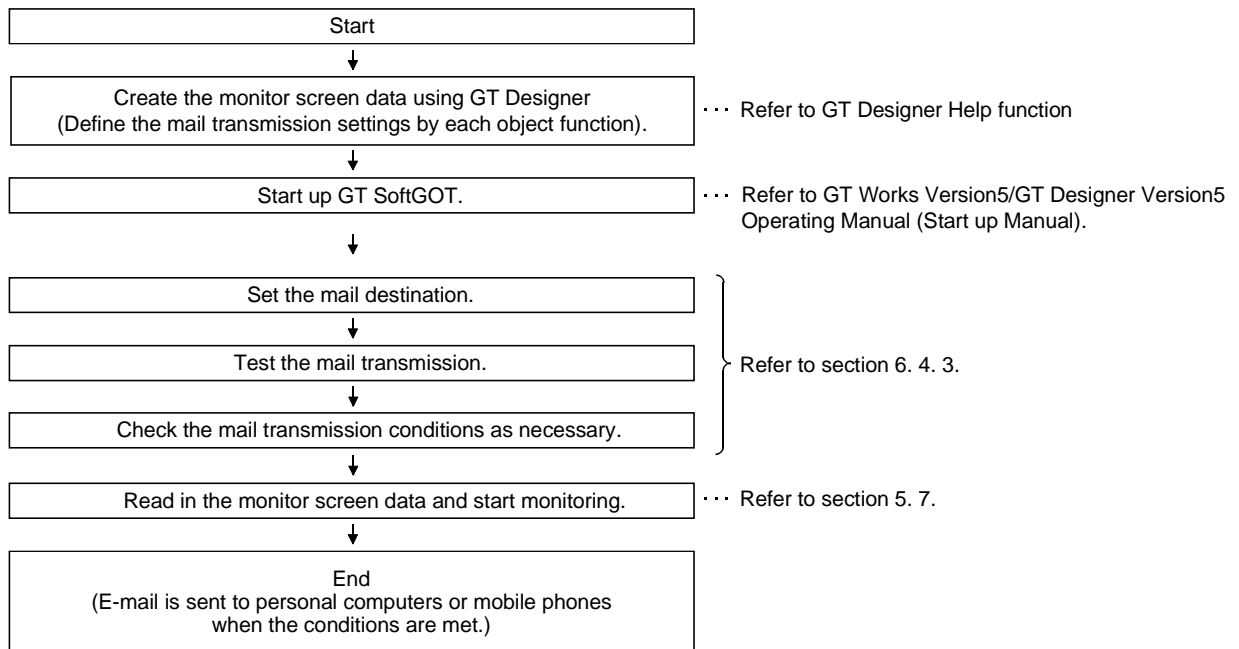

6.4.3 How to set up the mail function

The following explains how to set up the mail function to send e-mail using GT SoftGOT.

Mail Setup..... Used to set the mail destination and perform a mail transmission test.

Mail Condition ... Used to set the mail transmission conditions.



1) Choose any of the following to set up the mail function:

- "Mail" - "Mail Setup/Mail Condition"
- "Mail Setup/Mail Condition" in the tool bar
- "Mail" - "Mail Setup/Mail Condition" by right-clicking the mouse.

(Refer to Section 4.2 for right-clicking the mouse)



(Send Mail setup dialog box)

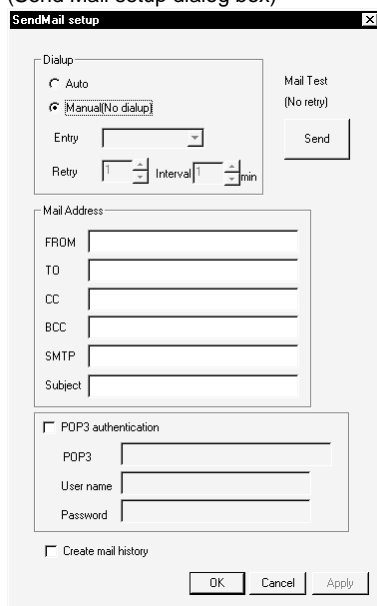

2) As the Send Mail setup dialog box or Mail Condition dialog box appears, make settings. (Refer to Section 6.4.3 (1), (2))

Clicking the button closes the dialog box.

(1) Contents of the mail setup dialogue box

The settings necessary to send e-mail from GT SoftGOT to the target device are defined below.

In addition, it is possible to perform mail transmission tests from this dialogue box.

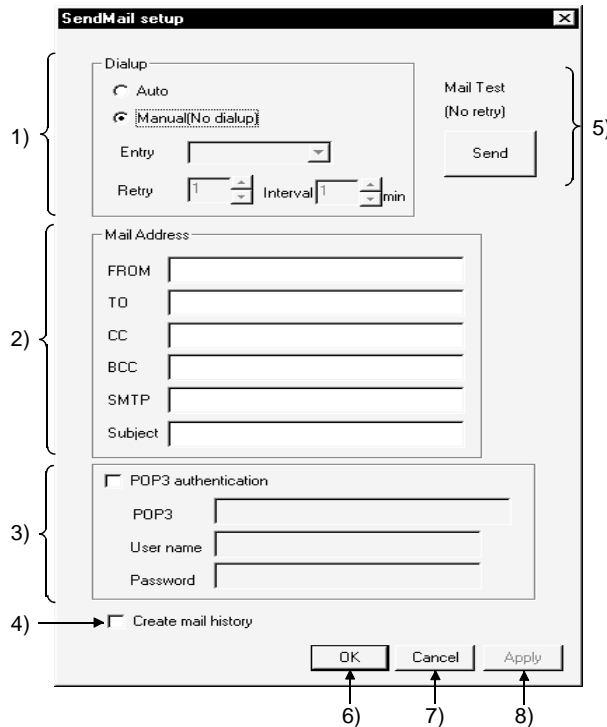

| Number | Item | Description |
|--------|---------------------|---|
| 1) | Dialup | Set whether or not to send e-mail via dialup. (The default is "Manual.") |
| | Auto | Check this radio button to send e-mail via dialup. If "Auto" is checked, a connection to the mail server is made and e-mail is sent when the mail conditions are established. The connection to the server is canceled after e-mail is sent. It is necessary to set "Entry," "Retry," and "Interval." |
| | Manual (No dialup) | Check this radio button to send e-mail without using dialup. If "Manual" is set, the connection to the mail server is always active when e-mail is sent. The connection to the server is not canceled even after e-mail is sent. |
| | Entry | Select the dialup connection entry name in Windows®. Refer to the Help function in Windows® for how to create a dial up entry. |
| | Retry | Set the number of retries made if a dialup fails. "0" to "10" (The default is "1.") |
| | Interval | Set the interval between retries. "1" to "10" (minutes) (The default is "1.") |
| 2) | Mail Address | Enter the origin, destination, server name, and title of mail. |
| | FROM | Enter the address of the mail origin. |
| | TO * | Enter the address of the mail destination. |
| | CC * | Enter the address of the mail destination (copy). (E-mail can be sent even this field is blank.) |
| | BCC * | Enter the address of the mail destination (blind copy). (E-mail can be sent even this field is blank.) |
| | SMTP | Enter the mail server name. |
| | Subject | Enter the title of the mail. |
| 3) | POP3 authentication | Enable the check box and enter the necessary information if POP3 authentication is required when sending e-mail. (The check box is disabled by default.) |
| | POP3 | Enter the POP3 server name. |
| | User name | Enter the user name. |
| | Password | Enter the password corresponding to the user name. |

| Number | Item | Description |
|--------|---------------------|---|
| 4) | Create mail history | Enable this check box to create a mail transmission history.
(The check box is disabled by default.) |
| 5) | Mail Test | Test e-mail is sent to the destination by clicking the "Send" button. |
| 6) | OK | Used to update the settings and close the dialog box. |
| 7) | Cancel | Used to cancel the settings and close the dialog box. |
| 8) | Apply | Used to update the settings. |

* If more than one address is entered, they should be separated with a space or a comma.

It is possible to enter up to 32 addresses per setting.

Up to 64 characters can be used for one address.

(a) Performing dialup (automatic)

The following explains an outline of how to make the necessary settings in order to perform dialup (automatically) by GT SoftGOT.

POINT
 Refer to the manual of the service provider and the Help function in Windows® for how to set the dialup network connection.

- 1) Set up the modem to be used.
- 2) Double-click "My Computer" - "Dial-up Networking" in Windows®.
 A wizard for creating dialup network connection is displayed. Follow the instructions on the screen to make the settings.
- 3) After creating the dialup network connection, double-click the icon created.
- 4) In the screen shown below, enter the user name and password specified by the service provider and enable the "Save password" check box.

When the setting is complete, click "Connect" and connect to the service provider.

If the connection is established successfully, cancel the connection and close the dialogue box.

<Example of Windows® 98 screen>

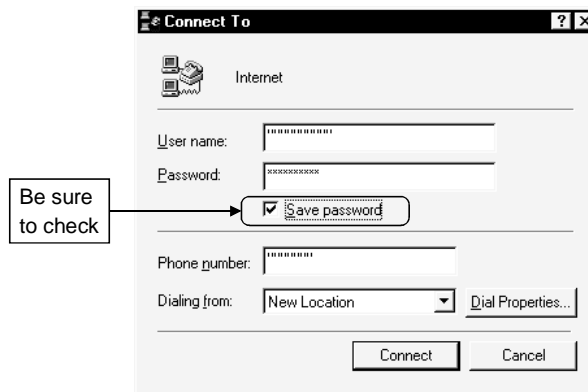

- 5) After making the settings mentioned above, it becomes possible to select the entry set in "Entry" of the mail setting by GT SoftGOT.

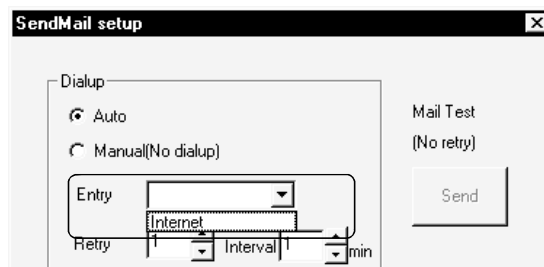

REMARK

If you run "Dialup (Auto)," be sure to log on when you start Windows®.

If you do not log on, you can not check "Save password" in step 4) above.

(b) Mail test

It is possible to check whether e-mail can be sent properly before starting monitoring by GT SoftGOT.

In the mail test, the following sample message of GT SoftGOT is sent to the destination based on the definition set in the Mail Setup dialogue box.

- 1) GT SoftGOT sample message displayed at the destination.

SoftGOT TEST MAIL
This is testmail.

POINT

If "Create mail history" is checked in the Mail Setup dialogue box, the status of the mail test is saved as one of the history data items.

Refer to Section 6.4.5 for a description of the mail history.

(2) Mail Condition Setup dialogue box

If the mail transmission is set with GT Designer, it is possible to set not to send e-mail for certain functions without modifying the monitor screen data.

Disable the functions for which e-mail is not to be sent.

(Check boxes are enabled by default.)

**POINT**

If the mail function is not set by each object function, this setting is ignored for that function (e-mail is not sent even if the check boxes are checked).

Refer to the Help function of GT Designer for how to set objects.

6.4.4 Sending e-mail

When e-mail is sent from GT SoftGOT to the target device, the reception header part shown at the destination displays a message that shows that the e-mail is from GT SoftGOT.

(a) Example of display in the reception header part at the destination

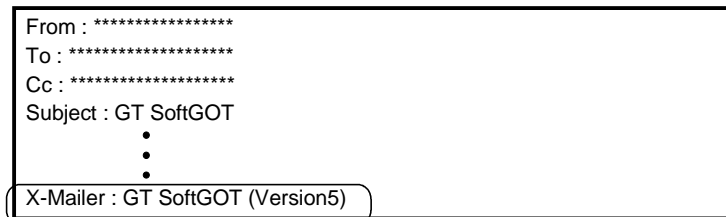

| |
|---|
| POINT |
| <ul style="list-style-type: none"> • The format and contents of the display of e-mail sent vary depending on the mailer specifications used at the destination. • When e-mail is sent to a mobile phone, the display may vary depending on the specifications (screen size) of the mobile phone. • GT SoftGOT can send up to 64 e-mail at one time. If alarms occur 65 times or more, the 65th e-mail and subsequent are not sent. |

(1) When sending e-mail using the alarm history display function

If an alarm occurs in GT SoftGOT, the time and information of the alarm are sent to the destination by e-mail.

Moreover, if the alarm recovers, the time and information of the alarm recovery are sent to the destination by e-mail.

For the details of the alarm history display functions, refer to the GT Designer help function.

(a) Example of display at the destination (when an alarm occurred)

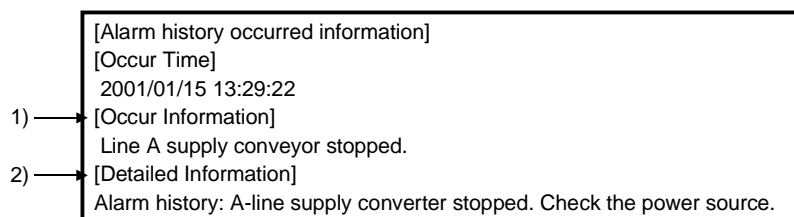

- 1) The comment entered in the alarm history display function is displayed.
- 2) The content of detailed display entered in the alarm history display function is displayed.

"Detailed Information" is not displayed if the details of the alarm history display function are set to be displayed in the base screen or window screen.

[Detailed Information] is not displayed if the detail display setting of the alarm history display function has not been made or if it has been made to the base screen or window screen.

"detail comment nothing" appears under [Detailed Information].

Set the details to be displayed in the comment window in order to display the "Detailed Information".

(b) Example of display at destination (when an alarm recovered)

[Alarm history repaired information]
 [repair Time]
 2001/01/15 13:40:59
 [repair Information]
 Alarm "Line A supply conveyor stopped." recovered.

(2) When sending e-mail using the time action function

E-mail with the following data attached is sent to the destination at the day of the week/time set with GT designer.

- Alarm history data..... CSV format file
- Recipe data..... CSV format file
- Display image BMP format file

For the details of the time action functions, refer to the GT Designer help function.

(a) Example of display at destination (when alarm history data is sent)

[Time Action]
 [Attribute]
 Daily SUN,FRI
 [Start time] 12:20:00
 Attached file Alarm history data

 Alarmhst.csv

POINT

Owing to the specification of the mobile phone to use, the e-mail with data may not be sent.

For the details, refer to the manual of the mobile phone to use.

6.4.5 Mail history

It is possible to reference the operation history data of the e-mail sent from GT SoftGOT.

It is also possible to reference the errors generated at the time e-mail was sent. The mail history data can be displayed using Notepad or a similar editor in Windows®.

(1) How to reference mail history

The following explains how to reference the mail history data.



1) Choose any of the following to reference mail history:

- "Mail" - "Mail History"
- "Mail History" in the tool bar
- "Mail" - "Mail History" by right-clicking the mouse.

(Refer to Section 4.2 for right-clicking the mouse)

(a) Example of mail history data display

```

2000/12/23 13:40:57 SMTP:***** Serch...
2000/12/23 13:40:58 SMTP:***** Connect...
2000/12/23 13:40:58 SMTP:***** Connect Complete.
2000/12/23 13:40:58 Sendmail Complete.
2000/12/23 14:01:23 SMTP:***** Serch...
2000/12/23 14:01:29 SMTP:***** is not found.
2000/12/23 14:01:29 Sendmail can not Complete.
2000/12/23 14:01:29 <ErrCode:***> *****

```

POINT

- The mail history cannot be referenced if the data does not exist.
In order to create a mail history, enable "Create mail history" in the Mail Setup dialogue box.
Refer to Section 6.4.4 for a description of the Mail Setup dialogue box.
- The mail history data is not deleted even if GT SoftGOT is closed.
The user should delete any history data that is no longer necessary.

6.5 Keyboard input function

The following operations can be performed using the keyboard input function.

- Input operations using the numerical input function and the ASCII input function can be performed from the keyboard.
- The numerical input function, ASCII input function, data list display function, alarm list display function and alarm history display function can be executed from the keyboard by assigning key codes to function keys (F1 to F8, [Shift]+F1 to [Shift]+F8).

6.5.1 Keyboard Input Enabling/Disabling Procedure

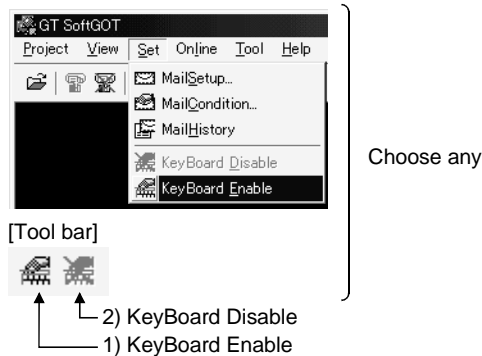

- 1) Input from the keyboard is disabled by default. Therefore, if you want to input from the keyboard, select one of the following.
 - "Set" - "KeyBoard Enable"
 - "KeyBoard Enable" on tool bar
 - "Mail" - "KeyBoard Enable" by right-clicking the mouse.
(Refer to Section 4.2 for right-clicking the mouse)
- 2) If you want to disable keyboard input again, select one of the following.
 - "Set" - "KeyBoard Disable"
 - "KeyBoard Disable" on tool bar
 - "Mail" - "KeyBoard Disable" by right-clicking the mouse.
(Refer to Section 4.2 for right-clicking the mouse)

6.5.2 When operating the numerical input function or the ASCII input function from the keyboard of a PC

When using the numerical input function or the ASCII input function, numeric values/ASCII codes can be entered from the keyboard of a PC.

The following lists the operation when each key is pressed.

| Type of key | Operation when entering a numeric value | Operation when entering ASCII code |
|------------------|--|---|
| [Back Space] key | Erases the least significant digit and shifts the entire content one digit to the right. | |
| [Enter] key | Confirms the current operation, writes to a device, and closes the current dialog box. | |
| [Esc] key | Displays/erases the cursor. | |
| [-] key | Inputs a minus sign. | |
| [.] key | Inputs a decimal point. | |
| Numeric key | Inputs numeric values (0 to 9). | Inputs ASCII code, shift JIS code, and letters. |
| Alphabetic key | Input alphabetic letters (A to F). | |
| Arrow key | Moves the cursor. | |
| [Delete] key | Erases a character being input. | |

6.5.3 How to Use the Function Keys

The numerical input function, ASCII input function, data list display function, alarm list display function and alarm history display function can be executed from the keyboard by assigning key codes to function keys (F1 to F8, [Shift]+F1 to [Shift]+F8). For more information about the key codes of each function, refer to the GT Works Version 5/GT Designer Version 5 Reference Manual.

(1) Assigning the key codes

Assign key codes to the Edit Operation panel dialog box of GT Designer.

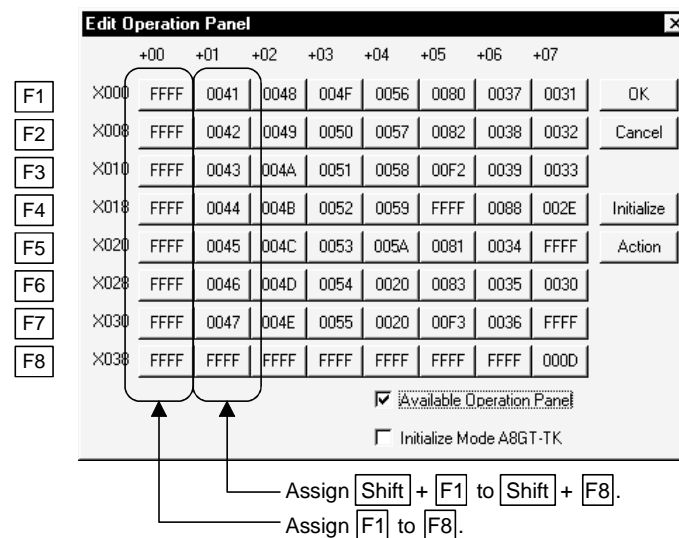

6.5.4 Precautions for Use

- (1) When a window screen is displayed over a base screen, and the alarm list display function or the alarm history display function has been set up on both the screens, key input is enabled for the alarm list display function or the alarm history display function on the base screen.
- (2) Do not set up multiple alarm list display functions or do not set up both the alarm list display function and the alarm history display function on a single base screen. If set up, the operations assigned to the function keys may not be performed properly.
- (3) No operation is performed even if a key is pressed while the touch switch to prohibit simultaneous key pressing is ON.
- (4) If any key input is performed while executing screen save, the screen save is cancelled. (The key entered does not operate as the key input function.)
- (5) If both key code "000D" (Enter key) and operation setting are specified to a function key using the numerical input function or the ASCII input function, the operation specified by the operation setting will not be performed.

6.6 Full Screen Mode Function

You can display the full monitor screen of GT SoftGOT on the personal computer screen.

When the full screen mode function is not used

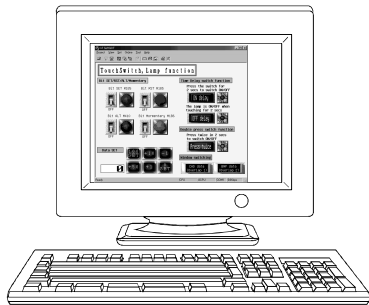

When the full screen mode function is not used, the frame part is displayed.

When the full screen mode function is used



When the full screen mode function is used, the frame part is hidden and the full monitor screen can be displayed on the personal computer.

POINT

- When using the full screen mode function, you cannot perform such operations as exiting from GT SoftGOT, since the menu bar, toolbar and status bar of GT SoftGOT are hidden.
To perform operations of the menu bar and toolbar, use the mouse right-click menu.
- If the full screen mode function is canceled, the toolbar and status bar remain hidden.
To display them, perform menu operation or right-click the mouse.

6.6.1 Full screen mode function types

There are the following full screen mode function types.

(1) Full screen 1

Only a monitor screen is displayed fully on the screen.

Use this function with the personal computer or panel computer where a mouse and keyboard are connected.

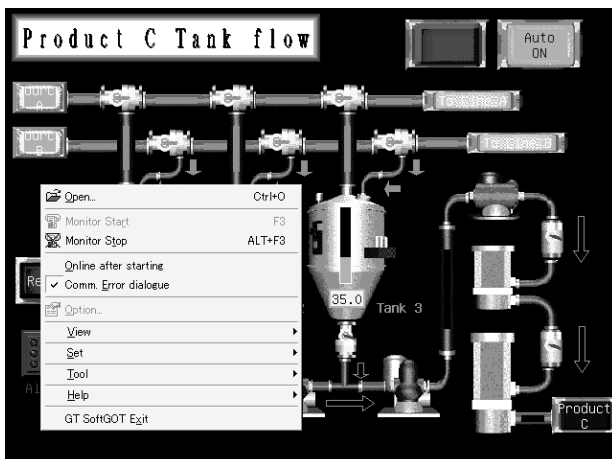

<Operation procedure>

- 1) The operations performed on the menu bar and toolbar can be performed by right-clicking the mouse.
- 2) Hold down the [Shift] key and double-click on the monitor screen to minimize the screen.
- 3) Press the F12 key (function key) to exit from GT SoftGOT.

(2) Full screen 2

A monitor screen is displayed fully on the screen with a small dialog. GT SoftGOT can be minimized/exited in the small dialog.

Since GT SoftGOT can be exited on the monitor screen, it can be used on the panel computer where a mouse and keyboard are not connected.

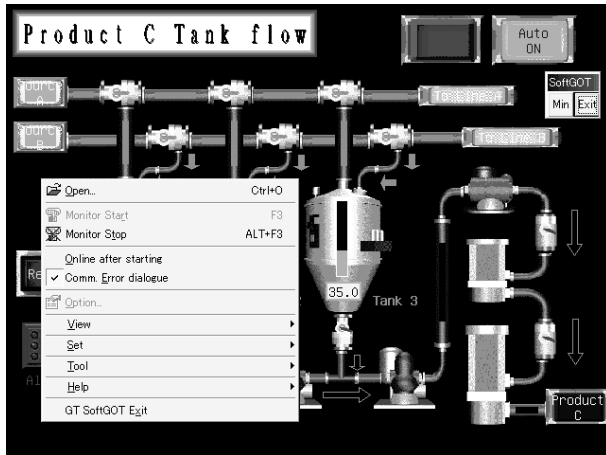

<Operation procedure>

- 1) The following operations can be performed in the small dialog.
 - Min: Minimizes GT SoftGOT.
 - Exit: Exits GT SoftGOT.
- 2) The operations performed on the menu bar and toolbar can be performed by right-clicking the mouse.
- 3) Hold down the [Shift] key and double-click on the monitor screen to minimize the screen.
- 4) Press the F12 key (function key) to exit from GT SoftGOT.

(3) Full screen 3

A monitor screen is displayed fully on the screen with a small dialog. GT SoftGOT can be opened/monitored/minimized/exited in the small dialog.

Since GT SoftGOT can be exited on the monitor screen, it can be used on the panel computer where a mouse and keyboard are not connected.

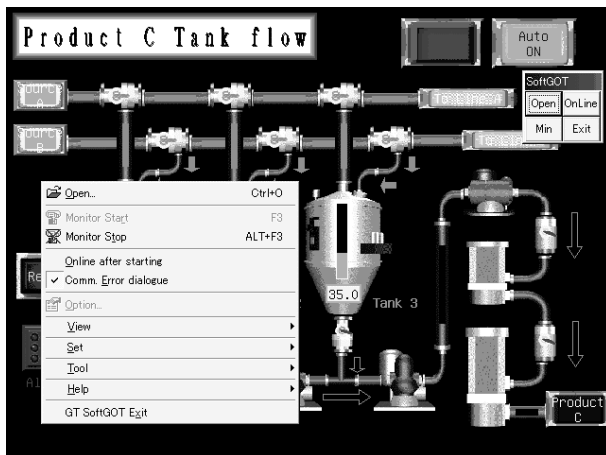

<Operation procedure>

- 1) The following operations can be performed in the small dialog.
 - Open: Opens a project.
 - Online: Starts monitoring.
(Cannot be selected during monitoring.)
 - Min: Minimizes GT SoftGOT.
 - Exit: Exits GT SoftGOT.
- 2) The operations performed on the menu bar and toolbar can be performed by right-clicking the mouse.
- 3) Hold down the [Shift] key and double-click on the monitor screen to minimize the screen.
- 4) Press the F12 key (function key) to exit from GT SoftGOT.

POINT

Turning ON the GOT internal device (system information area of GT SoftGOT: GS500.b0) exits GT SoftGOT.

By setting the above device as a touch switch, you can exit GT SoftGOT without using a mouse and keyboard.

For details of the GOT internal device, refer to the GT Works Version5/GT Designer Version5 Reference Manual.

6.6.2 Setting method

The full screen mode can either be set before or after starting GT SoftGOT.

(1) Method of setting before starting GT SoftGOT

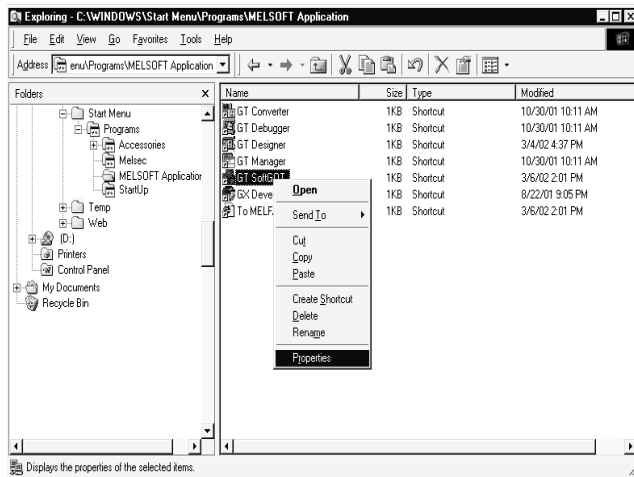

- 1) Choose the GT SoftGOT icon in the C:/Windows/startmenu/program/MELSOFT application and right-click the mouse to select the [Properties] menu. (If the GT SoftGOT starting icon was not registered at the time of installation, create the shortcut of the GT SoftGOT execution file (.EXE).)



<For display in full screen 1 mode>

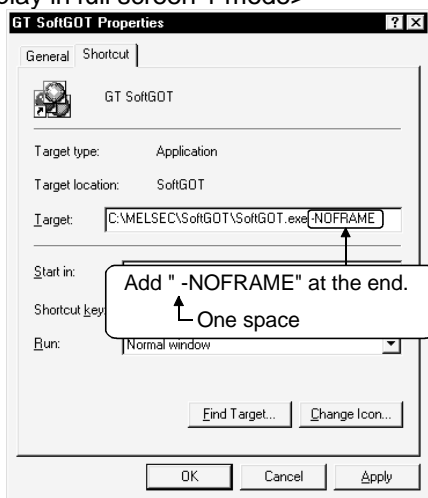

- 2) As the GT SoftGOT properties appear, choose the shortcut tab and add the keyword of the mode to be used to "Target".
 - Full screen 1: " -NOFRAME"
 - Full screen 2: " -NOFRAMEDLG"
 - Full screen 3: " -NOFRAMEDLGMENU"
- 3) After addition, click the [OK] button.
- 4) When GT SoftGOT is started next, GT SoftGOT is started in the full screen mode.
- 5) When you want to cancel the full screen mode, delete the keyword added to "Target".

(2) Method of setting after starting GT SoftGOT

| |
|---|
| POINT |
| <ul style="list-style-type: none"> • This setting is also made valid when you exit and restart GT SoftGOT. • When the full screen mode is set after the start of GT SoftGOT, GT SoftGOT is displayed in the full screen 1 mode.
When you want to display GT SoftGOT in the full screen 2 or 3 mode, set the full screen mode in the method (1). • When you have set the full screen mode in the method (1), you cannot cancel the full screen mode in this method.
To cancel the full screen mode, delete the keyword that was added to the link destination in (1). |

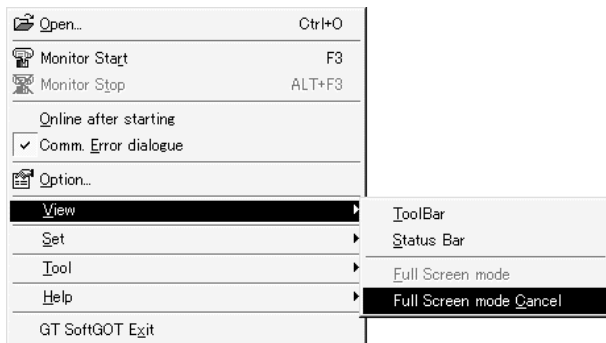
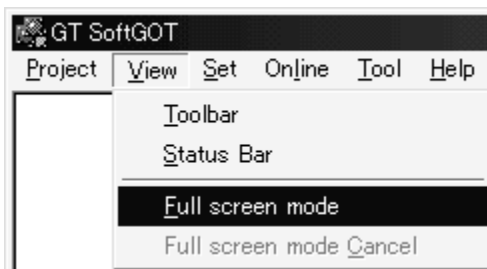

- 1) Choose either of the following.
 - "View" - "Full screen mode"
 - "View" - "Full screen mode" by right-clicking the mouse.
(Refer to Section 4.2 for right-clicking the mouse)
- 2) GT SoftGOT is displayed in the full screen 1 mode.
- 3) To cancel the full screen mode, right-click the mouse and select "View" - "Full screen mode cancel".

6.6.3 Precautions for use

- (1) The small dialog is movable but cannot be closed.
It is always displayed in the front position.

6.7 Disable/Enable of Popupmenu

The right-click of the mouse can be disabled (the menu can be hidden).

When the Popupmenu is set to be disabled, the menu is not displayed if you right-click the mouse.

This setting is also enabled when you exit and then restart GT SoftGOT.

6.7.1 Setting method

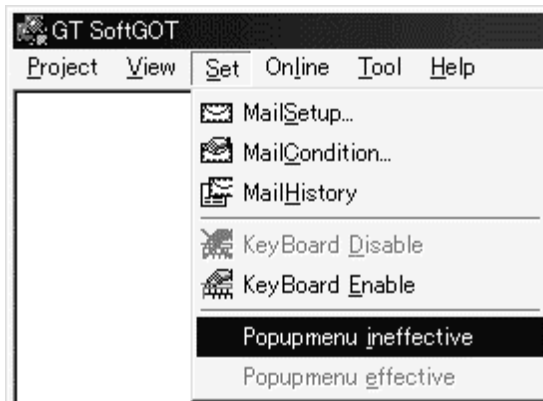

- 1) Choose either of the following.
 - "Set" - "Popupmenu ineffective"
 - "Set" - "Popupmenu ineffective" by right-clicking the mouse.
(Refer to Section 4.2 for right-clicking the mouse)
- 2) The right-click of the mouse is disabled.
- 3) When you want to enable the right-click of the mouse again, choose "Set" - "Popupmenu effective".

6.7.2 Precautions for use

- (1) When the full screen mode and Poppuppmenu disable are set, the operations of the menu bar and mouse right-click menu cannot be performed. Therefore, the pop-up menu cannot be enabled until the full screen mode is canceled. When you want to enable the pop-up menu, cancel the full screen mode in the following method.
 - (a) When the keyword of the full screen mode was added to the property of the GT SoftGOT icon.
After exiting GT SoftGOT (pressing the [F12] key or turning ON the GOT internal device GS500.b0), delete the added keyword.
 - (b) When the full screen mode was executed from the menu.
As the full screen mode is canceled by pressing the [Alt] + [F9] key, enable the Popupmenu from the menu.

Chapter 7 TROUBLESHOOTING

7.1 Error messages

The following table indicates the error messages displayed during use of GT SoftGOT, their definitions and causes, and corrective actions.

| Type | Error message | Definition and cause | Corrective action |
|--|--|---|---|
| Download | GOT type of the project is not correct. | <ul style="list-style-type: none"> GOT type of the read project is other than the GOT-A900 series (GOT-F900 series). The project's GOT type has been selected to GOT with resolution of 640 x 480 dots or less. | <ul style="list-style-type: none"> Change the GOT type of the project created on GT Designer to the GOT-A900 series. Change the GOT type of projects created with GT Designer to GOT with a resolution of 640 x 480 dots or more. |
| | PLC type of the project is different from setting 'GT SoftGOT'. | PLC type of the read project is different from the setting on GT SoftGOT. | Make correction so that the PLC type of the project created on GT Designer is the same as the CPU type of GT SoftGOT. |
| | Cannot access the project file. | Access to the specified project file could not be made. | Check the access right of the project file (e.g. a9gotp.got). |
| | Failed in reading.
Please retry after checking the following. <ul style="list-style-type: none"> Data size and number of the data. Capacity of free disk. Please close Dialogue if it is displayed. Waiting for 'Offline mode'. Please wait at several seconds. File access privilege of the project file. | Screen data size is too large. | Check to see if the screen data size is not more than 9M bytes. |
| | | Hard disk is short of free space. | Increase the free space of hard disk to more than 50M bytes. |
| | | Since the message such as "This function can't be used now." is displayed on the screen, read cannot be performed. | After choosing "OK" in the dialog box to erase the on-screen message, perform read again. |
| | | Waiting for the end processing of the script function.
(Waiting for offline mode) | After the message "Off-Line processing execution" appears on the screen, perform read again. |
| Access to the project file cannot be made. | Check the access right of the project file (e.g. a9gotp.got). | | |
| Online | The simulation cannot be ended.
Please retry after shutting Dialogue on the simulation screen | Since the message such as "This function can't be used now." is displayed on the screen, you cannot exit from GT SoftGOT properly.

There is the other internal cause than the above that does not allow you to exit from the software. | After choosing "OK" in the dialog box to erase the on-screen message, exit from GT SoftGOT again.

After choosing "OK" in the dialog box, wait for some time and exit from GT SoftGOT again. |
| | Please do logoff/the termination of Windows after ending 'GT SoftGOT'. | Logoff/exit processing of Windows was executed before exiting from GT SoftGOT. | After exiting from GT SoftGOT, execute logoff/exit processing of Windows. |
| | This function can't be used now. | You selected the function unusable with GT SoftGOT. | Press "OK". |
| Communication | check communication | Cable is disconnected.
Cable is open. | Check the cable. |
| | | Transmission speed (baudrate) is incorrect. | Check the transmission speed (baudrate) of the CPU. |
| | | Connection target PLC differs from the PLC type of the project. | Check the connection target PLC. |
| | Communication error occurred. <ul style="list-style-type: none"> Retry : Communication begins again. Cancel : Communication is interrupted. Please reexecute 'GT SoftGOT', if communicate agin. | Cable is disconnected.
Cable is open. | After checking for the left causes, choose the button in the displayed dialog box. "Retry" |
| | | Transmission speed (baudrate) is incorrect.

Connection target PLC differs from the PLC type of the project. | Restarts communication.
"Cancel"
After Cancel is selected, all communications will not be made. When performing monitor, restart GT SoftGOT. |

| Type | Error message | Definition and cause | Corrective action |
|---|--|--|---|
| License key (for DOS/V personal computer) | The license key is necessary to operate GT SoftGOT ends at about 10 minutes when executing without installing the license key. | The license key is not installed. | Check that the license key is installed. |
| | The license key is not installed. GT SoftGOT is ended. | | |
| License key FD (for PC CPU module) | This License key floppy disk is only for PPC-CPU. | The license registration destination is not the PC CPU module. | Register the license to the PC CPU module with the license key FD. |
| | This is a illegal License key floppy disk. Please insert the master floppy disk. | The floppy disk of the copied license key FD is inserted. | Register the license with the regular license key floppy disk. |
| | Failed to disable the product. Please use the License key floppy disk which you used to enable the product for disabling too. | An attempt was made to register a new license to the personal computer CPU module where the license has already been registered. | Register a new license after canceling the license with the license key FD that was used to register the license. |
| | Failed to enable the product, because this License key floppy disk has no license. | An attempt was made to register the license with the license key FD that does not hold the license. | Register the license using the license key FD that holds the license. |
| System driver | Failed to write on floppy disk. Please remove the write protect of floppy disk. | The license key FD is write-protected. | Write-enable the write-protected license key FD. |
| | The system driver to access the license key is not installed. Please install the system driver. | The system driver has not been installed. | Install the system driver. |

POINT

Regarding the communication time-out (system alarm 402) during Ethernet connection.

If a part of communication is in the condition of time-out error, "402 communication time-out" is displayed on the system alarm. (The dialog of communication will not be displayed.)

When the above error occurs, confirm the following.

- N/W No, PC No and IP address are correctly set for Ethernet setting.
- All of the other stations specified for Device setting are available.
- If the heavy load of PLC prevents the communication from completing within the time-out value set in advance, set the value larger.

7.2 Troubleshooting Related to the License Key

Check the following items if the license key is not recognized even if it has been installed on the DOS/V personal computer or the printer does not operate properly after being connected on the external side of the license key.

| Problem | Definition and cause | Corrective action |
|--------------------------------------|--|---|
| The license key cannot be recognized | The license key is connected to the personal computer's serial port. | Connect the license key to the printer port. |
| | The license key is installed on the DOS/V personal computer via the printer switch (the devices are installed in the order from the DOS/V personal computer, then the printer switch, and then the license key). | Install the license key closer to the DOS/V personal computer than the printer switch (i.e., install the devices in the order from the DOS/V personal computer, then the license key, and then the printer switch.) |
| | It is possible that the power supply to the printer port is shut off via setting of the DOS/V personal computer. | Change the settings so that the printer port can be used. |
| | The system driver is not installed. | Install the system driver. |
| | The parallel port may not be used unless the printer driver is set for each local port when using the Microsoft® Windows NT® Workstation 4.0 operating system. | Install the necessary printer drivers. (Complete the printer settings even if a printer is not used.) |
| | In the case of a Fujitsu-made FM/V Series computer | Install the system driver and restart the DOS/V personal computer. |
| Cannot print | If a printer cable that is 5 m or longer is used, the printing may be disturbed by noise from the surroundings. | Check the cable length. (Check the overall cable length when a switch is used.) |

7.3 Troubleshooting Related to Mail Transmission

(1) Troubleshooting

No dialogue boxes are displayed by GT SoftGOT for errors related to mail transmission and dialup.

| Problem | Definition and cause | Corrective action |
|-------------------|--|---|
| Mail is not sent. | The mail send setting of GT SoftGOT has not been made. | Make the mail send setting of GT SoftGOT. (Refer to Section 6.4.) |
| | Mail send setting has been made on GT Designer. | |
| | The mail send setting method is wrong. | Reexamine the mail send setting of GT SoftGOT. |

(2) Error code

No dialogue boxes are displayed by GT SoftGOT for errors related to mail transmission and dialup.

Refer to the mail history data for error codes and error messages.

Refer to Section 6.4.5 for how to reference the mail history data.

The following table lists the error codes related to mail transmission and dialup, their definitions and causes, and the corrective actions to take:

| Error code | Definition and cause | Corrective action |
|-------------|---|---|
| 600 to 750s | Setting errors of personal computers and peripheral devices (e.g., modem) | Refer to the Help function in Windows®. |

POINT

"SMTP Error Report : *****" is displayed in the mail history data if an error is reported from the mail server.

Consult the server administrator if this type of error occurs.

APPENDIX

Appendix1 List of Functions Added to Update GT SoftGOT

The following indicates the functions added to up to Version 29F of GT SoftGOT Version 5.

- : Allowed for use
- ×: Not allowed for use

POINT

In addition to the functions given in the following table, GT SoftGOT is also compatible with an update to GT Designer. For details of a GT Designer update, refer to the GT Works Version 5/GT Designer Version 5 Reference Manual.

(1) Connection forms added

| Item | Version5 | | | | | | |
|---|----------|---|---|---|---|-----|-----|
| | J | K | P | R | U | 26C | 29F |
| Ethernet Connection | × | ○ | ○ | ○ | ○ | ○ | ○ |
| Q Buss Connection | × | × | × | ○ | ○ | ○ | ○ |
| Computer link Connection | × | × | × | × | ○ | ○ | ○ |
| Connection with multiple PLC system | × | × | ○ | ○ | ○ | ○ | ○ |
| Connection with MELSEC-Q Series Q00J/Q00/Q01CPU | × | × | × | ○ | ○ | ○ | ○ |
| Connection with MELSEC-Q Series Q12PHCPU/Q25PHCPU | × | × | × | × | × | ○ | ○ |
| MELSECNET/10, MELSECNET/H connection | × | × | × | × | × | × | ○ |

(2) GT SoftGOT forms added

| Item | Description | Version5 | | | | | | |
|------------------|---|----------|---|---|---|---|-----|-----|
| | | J | K | P | R | U | 26C | 29F |
| Mail | Alarm occurrence or recovery from alarm is sent by e-mail using the alarm history display function. | × | ○ | ○ | ○ | ○ | ○ | ○ |
| | The alarm history data/recipe file/screen image is sent by e-mail using the time action function. | × | ○ | ○ | ○ | ○ | ○ | ○ |
| Keyboard input | The numerical input function or ASCII input function is entered from the keyboard of the personal computer. | × | × | × | × | ○ | ○ | ○ |
| Full screen mode | Full screen is displayed on the personal computer. | × | × | × | × | × | ○ | ○ |
| Popupmenu | Setting of whether the mouse right-click menu is disabled or enabled. | × | × | × | × | × | ○ | ○ |

APP

(3) Object functions added

| Item | | Version5 | | | | | | |
|-----------|--|----------|---|---|---|---|-----|-----|
| | | J | K | P | R | U | 26C | 29F |
| Hard copy | Compatible with the JPEG format when saving to the PC card | × | × | × | × | ○ | ○ | ○ |

(4) Other functions added

| Item | Description | Version5 | | | | | | |
|-----------------------|--|----------|---|---|---|---|-----|-----|
| | | J | K | P | R | U | 26C | 29F |
| Operating environment | GT SoftGOT is used in the PC CPU module. | × | × | × | ○ | ○ | ○ | ○ |
| | Compatible with Microsoft® Windows® Millennium Edition operating system or Microsoft® Windows® 2000 Professional operating system. | × | × | × | × | ○ | ○ | ○ |

INDEX

- [A]
 Access range 2-13
 Automatic Startup 5-29
- [C]
 Cable 2-7
 Clock display function 2-4
 Computer link units 2-5
 Converter 2-7
- [D]
 Data Reference function 6-3
 Description of the monitor data reading dialog box
 5-24
 Disable/Enable of Popumenu 6-20
- [E]
 Error messages 7-1
 Ethernet units and Ethernet boards/cards 2-5
 Execution of monitor 5-21
 Exiting from GT SoftGOT 5-25
- [F]
 Full screen mode function 6-16
 Function that cannot be Used 3-2
- [H]
 How to Attach the License Key 5-2
 How to set up the Computer link connection
 5-18
 How to set up the Ethernet connection 5-3
 How to set up the mail function 6-6
- [I]
 Install the system driver 5-2
- [K]
 KeyBoard input function 6-14
- [L]
 List of functions added to updated GT SoftGOT
 Version5 Appendix-1
- [M]
 Mail function 6-4
 Mail function overview 6-4
 Mail history 6-13
 MELFANSweb 4-3
 Memory card save 3-4
 Menu configuration 4-3
 Monitor data that may be monitored 3-4
- [N]
 Network units, Network boards 2-6
- [O]
 Opening the project 5-22
 Operating procedure overview 5-1
 Operation at Monitoring 5-25
 Operation environment 2-1
 Operation at monitoring 5-25
 Operation flow when using the mail function .. 6-5
 Option Setting 5-18
 Option Setting Dialog Box 5-19
- [P]
 Page setup 6-2
 PLC CPUs 2-4
 Print Function 6-2
 Print preview 6-2
- [Q]
 Q bus connection 2-14
- [R]
 Restrictions on and instructions for use of GT
 SoftGOT 3-4
 Restrictions on and instructions for PLC CPU
 connection 3-5

[S]

- Screen Configuration
 - Title bar 4-1
 - Menu bar..... 4-1
 - Dropdown menu 4-1
 - Monitor screen..... 4-1
 - Tool bar 4-2
 - Status bar..... 4-2
- Sending e-mail..... 6-11
- Serial communication units 2-5
- Snap shot function..... 6-1
- Specifications of the GT SoftGOT 3-1
- System configuration
 - System configuration at installation of GT SoftGOT 2-1
 - System configuration for GT SoftGOT Execution 2-2
- System monitor function 3-2

[T]

- Troubleshooting..... 7-2
- Troubleshooting Related to Mail Transmission7-3
- Troubleshooting Related to the License Key . 7-2

[U]

- Utility function 3-3

Microsoft Windows, Microsoft Windows NT are registered trademarks of Microsoft Corporation in the United States and other countries.

Pentium is a registered trademark of Intel Corporation in the United States and other countries.

Other company and product names herein are either trademarks or registered trademarks of their respective owners.

SPREAD

Copyright (C) 1998 Farpoin Technologies, Inc.

GT SoftGOT Version5

Operating Manual

| | |
|--------------------------|-----------------|
| MODEL | SW5-SOFTGOT-O-E |
| MODEL CODE | 1DM193 |
| SH(NA)-080156-G(0406)MEE | |

 **MITSUBISHI ELECTRIC CORPORATION**

HEAD OFFICE : 1-8-12, OFFICE TOWER Z 14F HARUMI CHUO-KU 104-6212 JAPAN
NAGOYA WORKS : 1-14 , YADA-MINAMI 5-CHOME , HIGASHI-KU, NAGOYA , JAPAN

When exported from Japan, this manual does not require application to the Ministry of Economy, Trade and Industry for service transaction permission.

Specifications subject to change without notice.