

**CP series CP1H CPU Unit**  
**CP1H-X□□D□-□/CP1H-Y□□D□-□**  
**CP1H-XA□□D□-□**

## 4 Axis Position Control and Comprehensive Programmable Controller

- The CP1H-X with pulse outputs for 4 axes.
- The CP1H-Y with 1-MHz pulse I/O.
- The CP1H-XA with pulse outputs for 4 axes and built-in analog I/O.



## Features

- Pulse output for 4 axes. Advanced power for high-precision positioning control.
- High-speed counters. Differential phases for 4 axes.  
Easily handles multi-axis control with a single unit.
- Eight interrupt inputs are built in. Faster processing of approximately 500 instructions speeds up the entire system.
- Serial communications. Two ports. Select Option Boards for either RS-232C or RS-485 communications.
- Ethernet Communications. Enabled by using an Option Board. Two ports can be used as an Ethernet port to perform. Ethernet communications between the CP1H and a host computer.
- Built-in Analog I/O. XA CPU Units provide 4 input words and 2 output words.
- USB Peripheral Port. Another standard feature.
- The structured text (ST) language. Makes math operations even easier.
- Can be used for the CP1W series and CJ series Unit. The extensibility of it is preeminently good.
- LCD displays and settings. Enabled using Option Board.

# CP1H

## Model Number Structure

■ Model Number Legend (Not all models that can be represented with the model number legend can necessarily be produced.)

**CP1H-□□D□-□**  
 (1) (2) (3) (4)

- |   |                                   |
|---|-----------------------------------|
| 1. Class                                | 3. Output classification          |
| X : Basic model                         | R : Relay output                  |
| XA : Built-in analog I/O terminals      | T : Transistor Output (sinking)   |
| Y : Dedicated pulse I/O terminals       | T1 : Transistor Output (sourcing) |
| 2. Number of Built-In number I/O points | 4. Power supply                   |
| 40 : 40 I/O points                      | A : AC                            |
| 20 : 20 I/O points                      | D : DC                            |

## Ordering Information

### ● International Standards





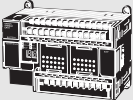
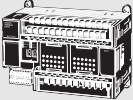
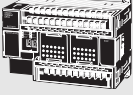

- The standards are abbreviated as follows: U: UL, U1: UL (Class I Division 2 Products for Hazardous Locations), C: CSA, UC: cULus, UC1: cULus (Class I Division 2 Products for Hazardous Locations), CU: cUL, N: NK, L: Lloyd, and CE: EC Directives.
- Contact your OMRON representative for further details and applicable conditions for these standards.

### ■ CPU Units

| CPU Unit   | Specifications  |                             |                                |                                |               | Model         | Standards                    |                |
|--|-----------------|-----------------------------|--------------------------------|--------------------------------|---------------|---------------|------------------------------|----------------|
|  | CPU type        | Power supply                | Output method                  | Inputs                         | Outputs       |               |                              |                |
|  <b>CP1H-X CPU Units</b><br>Memory capacity: 20K steps<br>High-speed counters: 100 kHz, 4 axes<br>Pulse outputs: 100 kHz, 4 axes<br>(Models with transistor outputs only)   | AC power supply | Relay output                | 24                             | 16                             | CP1H-X40DR-A  | UC1, N, L, CE |                              |                |
|  |                 | DC power supply             |                                |                                |               |               | Transistor output (sinking)  | CP1H-X40DT-D   |
|  |                 |                             |                                |                                |               |               | Transistor output (sourcing) | CP1H-X40DT1-D  |
|  <b>CP1H-XA CPU Units</b><br>Memory capacity: 20K steps<br>High-speed counters: 100 kHz, 4 axes<br>Pulse outputs: 100 kHz, 4 axes<br>(Models with transistor outputs only)<br>Analog inputs: 4<br>Analog outputs: 2 | AC power supply | Relay output                | 24                             | 16                             | CP1H-XA40DR-A | UC1, N, L, CE |                              |                |
|  |                 | DC power supply             |                                |                                |               |               | Transistor output (sinking)  | CP1H-XA40DT-D  |
|  |                 |                             |                                |                                |               |               | Transistor output (sourcing) | CP1H-XA40DT1-D |
|  <b>CP1H-Y CPU Units</b><br>Memory capacity: 20K steps<br>High-speed counters: 1 MHz, 2 axes<br>100 kHz, 2 axes<br>Pulse outputs: 1 MHz, 2 axes<br>100 kHz, 2 axes  | DC power supply | Transistor output (sinking) | 12 + line-driver input, 2 axes | 8 + line-driver output, 2 axes | CP1H-Y20DT-D  |               |                              |                |

Note: 1. CP1H PLCs are supported by CX-Programmer version 6.1 or higher.  
 2. Purchase a separately sold Option Unit if you will use RS-232C, RS-422A/485, Ethernet, or LCD.

### ■ Options for CPU Units

| Name  | Specifications  | Model      | Standards     |
|---|---|------------|---------------|
|  <b>RS-232C Option Board</b>                     | Can be mounted in either CPU Unit Option Board slot 1 or 2.   | CP1W-CIF01 | UC1, N, L, CE |
|  <b>RS-422A/485 Option Board</b>                 |   | CP1W-CIF11 |               |
|  <b>RS-422A/485 (Isolated-type) Option Board</b> |   | CP1W-CIF12 | UC1, N, L, CE |
|  <b>Ethernet Option Board</b>                    | Can be mounted in either CPU Unit Option Board slot 1 or 2. * | CP1W-CIF41 | UC1, N, L, CE |
|  <b>LCD Option Board</b>                         | Can be mounted only in the CPU Unit Option Board slot 1.      | CP1W-DAM01 | UC1, L, N, CE |
|  <b>Memory Cassette</b>                          | Can be used for backing up programs or auto-booting.          | CP1W-ME05M | UC1, N, L, CE |

\* When using CP1W-CIF41 Ver.1.0, one Ethernet port can be added.

Windows are either registered trademarks or trademarks of Microsoft Corporation in the United States and/or other countries.  
 Other company names and product names in this document are the trademarks or registered trademarks of their respective companies.

## ■ Programming Devices

| Name   | Specifications   |                            | Model        | Standards      |     |
|--|--|----------------------------|--------------|----------------|-----|
|  | Number of licenses   | Media                      |              |                |     |
| <b>FA Integrated Tool Package CX-One Lite Version 4.□</b>                                    | CX-One Lite is a subset of the complete CX-One package that provides only the Support Software required for micro PLC applications.<br>CX-One Lite runs on the following OS.<br>OS: Windows XP (Service Pack 3 or higher, 32-bit version) / Windows Vista (32-bit/64-bit version) / Windows 7 (32-bit/64-bit version) / Windows 8 (32-bit/64-bit version) / Windows 8.1 (32-bit/64-bit version)<br><br>CX-One Lite Ver. 4.□ includes Micro PLC Edition CX-Programmer Ver. 9.□. | 1 license                  | CD           | CXONE-LT01C-V4 | --- |
| <b>FA Integrated Tool Package CX-One Ver. 4.□</b>  | CX-One is a package that integrates the Support Software for OMRON PLCs and components. CX-One runs on the following OS.<br>OS: Windows XP (Service Pack 3 or higher, 32-bit version) / Windows Vista (32-bit/64-bit version) / Windows 7 (32-bit/64-bit version) / Windows 8 (32-bit/64-bit version) / Windows 8.1 (32-bit/64-bit version)<br><br>CX-One Ver. 4.□ includes CX-Programmer Ver. 9.□.  | 1 license<br>(See note 3.) | DVD          | CXONE-AL01D-V4 | --- |
| <b>Programming Device Connecting Cable for CP1W-CIF01 RS-232C Option Board (See note 4.)</b> | Connects Personal Computers, D-Sub 9-pin (Length: 2.0 m)   | For anti-static connectors | XW2Z-200S-CV | ---            |     |
|  | Connects Personal Computers, D-Sub 9-pin (Length: 5.0 m)   |                            | XW2Z-500S-CV |                |     |
|  | Connects Personal Computers, D-Sub 9-pin (Length: 2.0 m)   |                            | XW2Z-200S-V  |                |     |
|  | Connects Personal Computers, D-Sub 9-pin (Length: 5.0 m)   |                            | XW2Z-500S-V  |                |     |
| <b>USB-Serial Conversion Cable (See note 4.)</b>   | USB-RS-232C Conversion Cable (Length: 0.5 m) and PC driver (on a CD-ROM disc) are included.<br>Complies with USB Specification 2.0<br>On personal computer side: USB (A plug connector, male)<br>On PLC side: RS-232C (D-sub 9-pin, male)<br>Driver: Supported by Windows 98, Me, 2000, XP(32bit), Vista(32bit/64bit), 7(32bit/64bit) and 8(32bit/64bit)   |                            |              | CS1W-CIF31     | N   |

**Note:** 1. CP1H PLCs are supported by CX-Programmer version 6.1 or higher.

Update The CX-Programmer version automatically from the website using CX-Programmer version 7.0 (included with CX-One version 2.0).

2. The CX-One and CX-One Lite cannot be simultaneously installed on the same computer.

3. Multi licenses are available for the CX-One (3, 10, 30 or 50 licenses).

4. Cannot be used with a peripheral USB port.

To connect to a Personal Computers via a peripheral USB port, use commercially-available USB cable (A or B type, male).







The following tables lists the Support Software that can be installed from CX-One

| Support Software in CX-One      |         | CX-One Lite Ver.4.□ | CX-One Ver.4.□ | Support Software in CX-One    |         | CX-One Lite Ver.4.□ | CX-One Ver.4.□ |
|---------------------------------|---------|---------------------|----------------|-------------------------------|---------|---------------------|----------------|
| Micro PLC Edition CX-Programmer | Ver.9.□ | Yes                 | No             | CX-Drive                      | Ver.1.□ | Yes                 | Yes            |
| CX-Programmer                   | Ver.9.□ | No                  | Yes            | CX-Process Tool               | Ver.5.□ | No                  | Yes            |
| CX-Integrator                   | Ver.2.□ | Yes                 | Yes            | Faceplate Auto-Builder for NS | Ver.3.□ | No                  | Yes            |
| Switch Box Utility              | Ver.1.□ | Yes                 | Yes            | CX-Designer                   | Ver.3.□ | Yes                 | Yes            |
| CX-Protocol                     | Ver.1.□ | No                  | Yes            | NV-Designer                   | Ver.1.□ | Yes                 | Yes            |
| CX-Simulator                    | Ver.1.□ | Yes                 | Yes            | CX-Thermo                     | Ver.4.□ | Yes                 | Yes            |
| CX-Position                     | Ver.2.□ | No                  | Yes            | CX-ConfiguratorFDT            | Ver.1.□ | Yes                 | Yes            |
| CX-Motion-NCF                   | Ver.1.□ | No                  | Yes            | CX-FLnet                      | Ver.1.□ | No                  | Yes            |
| CX-Motion-MCH                   | Ver.2.□ | No                  | Yes            | Network Configurator          | Ver.3.□ | Yes                 | Yes            |
| CX-Motion                       | Ver.2.□ | No                  | Yes            | CX-Server                     | Ver.4.□ | Yes                 | Yes            |

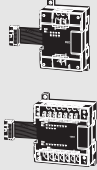
**Note:** For details, refer to the CX-One Catalog (Cat. No: R134).

# CP1H

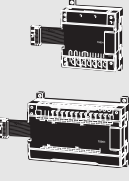
## ■ Expansion Units

| Product name   | Inputs | Outputs               | Output type  | Model               | Standards      |               |
|--|--------|-----------------------|--|---------------------|----------------|---------------|
| <b>Input Unit</b>  | 8      | --                    | 24 VDC Input   | CP1W-8ED            | U, C, N, L, CE |               |
| <b>Output Units</b><br>               | --     | 8                     | Relay  | CP1W-8ER            |                |               |
|  |        |                       | Transistor (sinking)   | CP1W-8ET            |                |               |
|  |        |                       | Transistor (sourcing)  | CP1W-8ET1           |                |               |
|  | --     | 16                    | Relay  | CP1W-16ER           |                |               |
|  |        |                       | Transistor (sinking)   | CP1W-16ET           |                |               |
|  |        |                       | Transistor (sourcing)  | CP1W-16ET1          |                |               |
| --   | 32     | Relay                 | CP1W-32ER  |                     |                |               |
|  |        | Transistor (sinking)  | CP1W-32ET  |                     |                |               |
|  |        | Transistor (sourcing) | CP1W-32ET1   |                     |                |               |
| <b>I/O Units</b><br>                  | 12     | 8                     | Relay  | CP1W-20EDR1         | U, C, N, L, CE |               |
|  |        |                       | Transistor (sinking)   | CP1W-20EDT          |                |               |
|  |        |                       | Transistor (sourcing)  | CP1W-20EDT1         |                |               |
|  | 24     | 16                    | Relay  | CP1W-40EDR          | N, L, CE       |               |
|  |        |                       | Transistor (sinking)   | CP1W-40EDT          |                |               |
|  |        |                       | Transistor (sourcing)  | CP1W-40EDT1         |                |               |
| <b>Analog Input Unit</b><br>          | 4CH    | --                    | Input range:<br>0 to 5 V, 1 to 5 V, 0 to 10 V, ±10 V, 0 to 20 mA, or 4 to 20 mA.   | Resolution: 1/6000  | CP1W-AD041     | UC1, N, L, CE |
|  |        |                       |  | Resolution: 1/12000 | CP1W-AD042     | UC1, N, CE    |
| <b>Analog Output Unit</b><br>        | --     | 2CH                   | Output range:<br>1 to 5 V, 0 to 10 V, ±10 V, 0 to 20 mA, or 4 to 20 mA.  | Resolution: 1/6000  | CP1W-DA021     | UC1, N, L, CE |
|  | --     | 4CH                   |  | Resolution: 1/6000  | CP1W-DA041     |               |
|  |        |                       |  | Resolution: 1/12000 | CP1W-DA042     | UC1, N, CE    |
| <b>Analog I/O Unit</b><br>          | 4CH    | 4CH                   | Input range:<br>0 to 5 V, 1 to 5 V, 0 to 10 V, ±10 V, 0 to 20 mA, or 4 to 20 mA.   | Resolution: 1/12000 | CP1W-MAD44     | UC1, N, CE    |
|  | 4CH    | 2CH                   |  | Resolution: 1/12000 | CP1W-MAD42     |               |
|  | 2CH    | 1CH                   | Output range:<br>1 to 5 V, 0 to 10 V, ±10 V, 0 to 20 mA, or 4 to 20 mA.  | Resolution: 1/6000  | CP1W-MAD11     | UC1, N, L, CE |
| <b>Temperature Sensor Unit</b><br>  | 2CH    | --                    | Sensor type: Thermocouple (J or K)   |                     | CP1W-TS001     | UC1, N, L, CE |
|  | 4CH    | --                    | Sensor type: Thermocouple (J or K)   |                     | CP1W-TS002     |               |
|  | 2CH    | --                    | Sensor type: Platinum resistance thermometer (Pt100 or JPt100)   |                     | CP1W-TS101     |               |
|  | 4CH    | --                    | Sensor type: Platinum resistance thermometer (Pt100 or JPt100)   |                     | CP1W-TS102     |               |
|  | 4CH    | --                    | Sensor type: Thermocouple (J or K)<br>2 channels can be used as analog input.<br>Input range: 1 to 5 V, 0 to 10 V, 4-20 mA | Resolution: 1/12000 | CP1W-TS003     |               |
|  | 12CH   | --                    | Sensor type: Thermocouple (J or K)   |                     | CP1W-TS004     |               |
| <b>CompoBus/S I/O Link Unit</b><br> | 8      | 8                     | CompoBus/S slave   |                     | CP1W-SRT21     | UC1, N, L, CE |

## ■ I/O Connecting Cable

| Name                 | Specifications                   | Model      | Standards     |
|----------------------|----------------------------------|------------|---------------|
| I/O Connecting Cable | 80 cm (for CP1W Expansion Units) | CP1W-CN811 | UC1, N, L, CE |

Note: An I/O Connecting Cable (approx. 6 cm) for horizontal connection is provided with CP1W Expansion Units.

## ■ Optional Products, Maintenance Products and DIN Track Accessories

| Name               | Specifications   | Model      | Standards |
|--------------------|--|------------|-----------|
| <b>Battery Set</b> | For CP1H CPU Units<br>(Use batteries within two years of manufacture.)   | CJ1W-BAT01 | CE        |
| <b>DIN Track</b>   | Length: 0.5 m; Height: 7.3 mm  | PFP-50N    | ---       |
|                    | Length: 1 m; Height: 7.3 mm  | PFP-100N   |           |
|                    | Length: 1 m; Height: 16 mm   | PFP-100N2  |           |
| <b>End Plate</b>   | There are 2 stoppers provided with a CJ Unit Adapter as standard accessories to secure the Units on the DIN Track. | PFP-M      |           |

### ■ CJ-series Special I/O Units and CPU Bus Units

| Category                                | Name  | Specifications   | Model   | Standards     |
|---|---|--|---|---------------|
| CP1H CPU Unit options                   | CJ Unit Adapter   | Adapter for connecting CJ-series Special I/O Units and CPU Bus Units (includes CJ-series End Cover and 2 End Plates)   | CP1W-EXT01  | UC1, N, L, CE |
| CJ1 Special I/O Units                   | Analog Input Units  | 4 inputs (1 to 5 V (1/10,000), 0 to 10 V (1/20,000), -5 to 5 V (1/20,000), -10 to 10 V (1/40,000), and 4 to 20 mA (1/10,000))<br>Conversion Period: 20 μs/1 point, 25 μs/2 points, 30 μs/3 points, 35 μs/4 points  | CJ1W-AD042  | UC1, CE       |
|   |   | 8 inputs (1 to 5 V, 0 to 5 V, 0 to 10 V, -10 to 10 V, 4 to 20 mA)<br>Resolution: 1/8,000, Conversion speed: 250 μs/input max.<br>(Can be set to 1/4,000 resolution and 1 ms/input.)  | CJ1W-AD081-V1   | UC1, N, L, CE |
|   |   | 4 inputs (1 to 5 V, 0 to 5 V, 0 to 10 V, -10 to 10 V, 4 to 20 mA)<br>Resolution: 1/8,000, Conversion speed: 250 μs/input max.<br>(Can be set to 1/4,000 resolution and 1 ms/input.)  | CJ1W-AD041-V1   |               |
|   | Analog Output Units   | 4 outputs (1 to 5 V (1/10,000), 0 to 10 V (1/20,000), and -10 to 10 V (1/40,000))<br>Conversion Period: 20 μs/1 point, 25 μs/2 points, 30 μs/3 points, 35 μs/4 points  | CJ1W-DA042V   | UC1, CE       |
|   |   | 8 outputs (1 to 5 V, 0 to 5 V, 0 to 10 V, -10 to 10 V)<br>Resolution: 1/4,000; Conversion speed: 1 ms/output max.<br>(Can be set to 1/8000, 250 μs/output.)  | CJ1W-DA08V  | UC1, N, L, CE |
|   |   | 8 outputs (4 to 20 mA)<br>Resolution: 1/4,000; Conversion speed: 1 ms/output max.<br>(Can be set to 1/8,000, 250 μs/output.)   | CJ1W-DA08C  | UC1, N, CE    |
|   |   | 4 outputs (1 to 5 V, 0 to 5 V, 0 to 10 V, -10 to 10 V, 4 to 20 mA)<br>Resolution: 1/4,000, Conversion speed: 1ms/point max.  | CJ1W-DA041  | UC1, N, L, CE |
|   |   | 2 outputs (1 to 5 V, 0 to 5 V, 0 to 10 V, -10 to 10 V, 4 to 20 mA)<br>Resolution: 1/4,000, Conversion speed: 1ms/point max.  | CJ1W-DA021  |               |
|   | Analog I/O Unit   | 4 inputs, 2 outputs (1 to 5 V, 0 to 5 V, 0 to 10 V, -10 to 10 V, 4 to 20 mA)<br>Resolution: 1/4000; Conversion speed: 1 ms/point max.<br>(Can be set to 1/8,000, 500 μs/point.)  | CJ1W-MAD42  |               |
|   | Process Input Units   | 4 fully universal inputs: Pt100 (3-wire), JPt100 (3-wire), Pt1000 (3-wire), Pt100 (4 wire), K, J, T, E, L, U, N, R, S, B, WRe5-26, PL11, 4 to 20 mA, 0 to 20 mA, 1 to 5 V, 0 to 1.25 V, 0 to 5 V, 0 to 10 V, ±100-mV selectable range, -1.25 to 1.25 V, -5 to 5 V, -10 to 10 V, ±10-V selectable range<br>Potentiometer resolution/conversion speed: 1/256,000 (conversion cycle: 60 ms/4 points), 1/64,000 (conversion cycle: 10 ms/4 points), 1/16,000 (conversion cycle: 5 ms/4 points) | CJ1W-PH41U *  | UC1, CE       |
|   |   | 4 fully universal inputs: Pt100, JPt100, Pt1000, K, J, T, L, R, S, B, 4 to 20 mA, 0 to 20 mA, 1 to 5 V, 0 to 5 V, 0 to 10 V<br>Conversion speed: 250 ms/4 points   | CJ1W-AD04U  | UC1, L, CE    |
|   |   | 4 inputs, B, J, K, L, R, S, T; Conversion speed: 250 ms/4 inputs   | CJ1W-PTS51  | UC1, CE       |
|   |   | 4 inputs, Pt100 Ω (JIS, IEC), JPt100 Ω, Conversion speed: 250 ms/4 inputs  | CJ1W-PTS52  |               |
|   |   | 2 inputs, B, E, J, K, L, N, R, S, T, U, W, Re5-26, PL ±100 mV, Resolution: 1/64,000; Conversion speed: 10 ms/2 inputs  | CJ1W-PTS15  |               |
|   |   | Temperature Control Units  | 2 inputs, 0 to 1.25 V, -1.25 to 1.25 V, 0 to 5 V, 1 to 5 V, -5 to 5 V, 0 to 10 V, -10 to 10 V, ±10-V selectable range, 0 to 20 mA, 4 to 20 mA | CJ1W-PDC15    |
|   | 4 loops, thermocouple input, NPN output   |  | CJ1W-TC001  | UC1, N, L, CE |
|   | 4 loops, thermocouple input, PNP output   |  | CJ1W-TC002  |               |
|   | 2 loops, thermocouple input, NPN output, heater burnout detection function                    |  | CJ1W-TC003  |               |
|   | 2 loops, thermocouple input, PNP output, heater burnout detection function                    |  | CJ1W-TC004  |               |
|   | 4 loops, platinum resistance thermometer input, NPN output                                    |  | CJ1W-TC101  |               |
|   | 4 loops, platinum resistance thermometer input, PNP output                                    |  | CJ1W-TC102  |               |
|   | 2 loops, platinum resistance thermometer input, NPN output, heater burnout detection function | CJ1W-TC103   |   |               |
|   | 2 loops, platinum resistance thermometer input, PNP output, heater burnout detection function | CJ1W-TC104   |   |               |
|   | High-speed Counter Unit   | 2 inputs, max. input frequency: 500 kpps   | CJ1W-CT021  | UC1, N, L, CE |
|   | Position Control Units  | Pulse train, open collector output, 1 axis   | CJ1W-NC113  | UC1, CE       |
|   |   | Pulse train, open collector output, 2 axes   | CJ1W-NC213  |               |
|   |   | Pulse train, open collector output, 4 axes   | CJ1W-NC413  |               |
| Pulse train, line driver output, 1 axis |   | CJ1W-NC133   |   |               |
| Pulse train, line driver output, 2 axes |   | CJ1W-NC233   |   |               |
| Pulse train, line driver output, 4 axes |   | CJ1W-NC433   |   |               |
| Space Unit                              | ---   | CJ1W-SP001   |   |               |
| ID Sensor Units                         | For V680 Series, 1 R/W Head   | CJ1W-V680C11   | UC, CE  |               |
|   | For V680 Series, 2 R/W Heads  | CJ1W-V680C12   |   |               |
|   | For V600 Series, 1 R/W Head   | CJ1W-V600C11   |   |               |
|   | For V600 Series, 2 R/W Heads  | CJ1W-V600C12   |   |               |
| CompoNet Master Unit                    | Word slaves: 2,048 points, Bit slaves: 512 points   | CJ1W-CRM21   | U, U1, N, L, CE   |               |
| CompoBus/S Master Unit                  | CompoBus/S remote I/O, 256 points max.  | CJ1W-SRM21   | UC1, N, L, CE   |               |



\* If a CJ1W-PH41U is used, do not use a CP1H CPU Unit with relay contact outputs or Expansion Units with relay contact outputs.

**Note:** Refer to the *CJ1 catalog* (Cat. No. P052) for information on the CJ1 Special I/O Units.

| Category          | Name                                  | Specifications   | Model         | Standards     |         |
|-------------------|---------------------------------------|--|---------------|---------------|---------|
| CJ1 CPU Bus Units | Controller Link Units                 | Wired (shielded twisted-pair cable)  | CJ1W-CLK23    | UC1, N, L, CE |         |
|                   | Serial Communications Units           | 1 RS-232C port and 1 RS-422A/485 port  | CJ1W-SCU42    | UC1, N, L, CE |         |
|                   |                                       | 2 RS-232C ports  | CJ1W-SCU22    |               |         |
|                   |                                       | 2 RS-422A/485 ports  | CJ1W-SCU32    |               |         |
|                   |                                       | 1 RS-232C port and 1 RS-422A/485 port  | CJ1W-SCU41-V1 | UC1, N, L, CE |         |
|                   |                                       | 2 RS-232C ports  | CJ1W-SCU21-V1 |               |         |
|                   |                                       | 2 RS-422A/485 ports  | CJ1W-SCU31-V1 |               |         |
|                   | EtherNet/IP Unit                      | Shielded twisted-pair cable (STP), category 5 or 5e or higher<br>Tag data links and message communications supported   | CJ1W-EIP21    | UC1, N, L, CE |         |
|                   | Ethernet Unit                         | 100Base-TX   | CJ1W-ETN21    |               |         |
|                   | DeviceNet™ Unit                       | Functions as master and/or slave; allows control of 32,000 points max. per master  | CJ1W-DRM21    |               |         |
|                   | MECHATROLINK-II Position Control Unit | Control commands sent using MECHATROLINK-II synchronized communications<br>16 axes max., direct operation from ladder diagram, control modes: position/ speed/torque | 2 axes        | CJ1W-NC271    | UC1, CE |
|                   |                                       |  | 4 axes        | CJ1W-NC471    |         |
|                   |                                       |  | 16 axes       | CJ1W-NCF71    |         |
| 16 axes           |                                       |  | CJ1W-NCF71-MA |               |         |
| FI-net Unit       | 100Base-TX                            | CJ1W-FLN22   | UC1, CE       |               |         |
| SPU               | High-speed Data Storage Unit          | CJ1W-SPU01-V2  |               |               |         |

Note: Refer to the *CJ1 catalog* (Cat. No. P052) for information on the CJ1 CPU Bus Units.

## Industrial Switching Hubs

| Product name              | Appearance  | Specifications  |              |                   | Accessories              | Current consumption (A)                                     | Model    | Standards |
|---------------------------|---|---|--------------|-------------------|--------------------------|---|----------|-----------|
|                           |   | Functions   | No. of ports | Failure detection |                          |   |          |           |
| Industrial Switching Hubs |  | Quality of Service (QoS):<br>EtherNet/IP™ control data priority                               | 3            | No                | • Power supply connector | 0.22  | W4S1-03B | UC, CE    |
|                           |  | Failure detection:<br>Broadcast storm and LSI error detection 10/100BASE-TX, Auto-Negotiation | 5            | No                |                          | • Power supply connector<br>• Connector for informing error | 0.22     |           |
|                           |   |   |              | 5                 | Yes                      |   |          | 0.22      |

## General Specifications

| Item                          | Type<br>Model | AC power supply models   | DC power supply models   |
|-------------------------------|---------------|--|--|
|                               |               | CP1H-□□□-A   | CP1H-□□□-D   |
| Power supply                  |               | 100 to 240 VAC 50/60 Hz  | 24 VDC   |
| Operating voltage range       |               | 85 264 VAC   | 20.4 to 26.4 VDC<br>(with 4 or more Expansion Units and Expansion I/O Units: 21.6 to 26.4 VDC) |
| Power consumption             |               | 100 VA max. (CP1H-□□□-A)(page 28)  | 50 W max. (CP1H-□□□-D)(page 28)  |
| Inrush current (See note.)    |               | 100 to 120 VAC inputs:<br>20 A max. (for cold start at room temperature)<br>8 ms max.<br>200 to 240 VAC inputs:<br>40 A max. (for cold start at room temperature), 8 ms max.   | 30 A max. (for cold start at room temperature)<br>20 ms max.                                   |
| External power supply         |               | 300 mA at 24 VDC   | None   |
| Insulation resistance         |               | 20 MΩ min. (at 500 VDC) between the external AC terminals and GR terminals   | No insulation between primary and secondary for DC power supply                                |
| Dielectric strength           |               | 2,300 VAC at 50/60 Hz for 1 min between the external AC and GR terminals, leakage current: 5 mA max.   | No insulation between primary and secondary for DC power supply                                |
| Noise immunity                |               | Conforms to IEC 61000-4-4. 2 kV (power supply line)  |  |
| Vibration resistance          |               | Conforms to JIS C60068-2-6. 10 to 57 Hz, 0.075-mm amplitude, 57 to 150 Hz, acceleration: 9.8 m/s <sup>2</sup> in X, Y, and Z directions for 80 minutes each. Sweep time: 8 minutes × 10 sweeps = total time of 80 minutes) |  |
| Shock resistance              |               | Conforms to JIS C60068-2-27. 147 m/s <sup>2</sup> three times each in X, Y, and Z directions   |  |
| Ambient operating temperature |               | 0 to 55°C  |  |
| Ambient humidity              |               | 10% to 90% (with no condensation)  |  |
| Ambient operating environment |               | No corrosive gas   |  |
| Ambient storage temperature   |               | -20 to 75°C (Excluding battery.)   |  |
| Power holding time            |               | 10 ms min.   | 2 ms min.  |

**Note:** The above values are for a cold start at room temperature for an AC power supply, and for a cold start for a DC power supply.

- A thermistor (with low-temperature current suppression characteristics) is used in the inrush current control circuitry for the AC power supply. The thermistor will not be sufficiently cooled if the ambient temperature is high or if a hot start is performed when the power supply has been OFF for only a short time. In those cases the inrush current values may be higher (as much as two times higher) than those shown above. Always allow for this when selecting fuses and breakers for external circuits.
- A capacitor charge-type delay circuit is used in the inrush current control circuitry for the DC power supply. The capacitor will not be charged if a hot start is performed when the power supply has been OFF for only a short time, so in those cases the inrush current values may be higher (as much as two times higher) than those shown above.



# CP1H

## Performance Specifications

| Item  | Type Models  | CP1H-XA CPU Units   | CP1H-X CPU Units                         | CP1H-Y CPU Units |
|---|--|---|--|------------------|
|   |  | CP1H-XA□□□□□  | CP1H-X□□□□□                              | CP1H-Y□□□□□      |
| Control method                              |  | Stored program method   |  |                  |
| I/O control method                          |  | Cyclic scan with immediate refreshing   |  |                  |
| Program language                            |  | Ladder diagram  |  |                  |
| Function blocks                             |  | Maximum number of function block definitions: 128 Maximum number of instances: 256<br>Languages usable in function block definitions: Ladder diagrams, structured text (ST) |  |                  |
| Instruction length                          |  | 1 to 7 steps per instruction  |  |                  |
| Instructions                                |  | Approx. 500 (function codes: 3 digits)  |  |                  |
| Instruction execution time                  |  | Basic instructions: 0.10 μs min. Special instructions: 0.15 μs min.   |  |                  |
| Common processing time                      |  | 0.7 ms  |  |                  |
| Program capacity                            |  | 20K steps   |  |                  |
| Number of tasks                             |  | 288 (32 cyclic tasks and 256 interrupt tasks)   |  |                  |
|   | Scheduled interrupt tasks  | 1 (interrupt task No. 2, fixed)   |  |                  |
|   | Input interrupt tasks  | 8 (interrupt task No. 140 to 147, fixed)  | 6 (interrupt task No. 140 to 145, fixed) |                  |
|   |  | (Interrupt tasks can also be specified and executed for high-speed counter interrupts.)   |  |                  |
| Maximum subroutine number                   |  | 256   |  |                  |
| Maximum jump number                         |  | 256   |  |                  |
| I/O areas<br>(See note.)                    | Input bits   | 272bits (17 words) : CIO 0.00 to 16.15  |  |                  |
|   | Output bits  | 272bits (17 words) : CIO 100.00 to 116.16   |  |                  |
|   | Built-in Analog Inputs   | CIO 200 to CIO 203  | ---                                      |                  |
|   | Built-in Analog Outputs  | CIO 210 to CIO 211  | ---                                      |                  |
|   | Serial PLC Link Area   | 1,440 bits (90 words): CIO 3100.00 to CIO 3189.15 (CIO 3100 to CIO 3189)  |  |                  |
| Work bits                                   | 8,192 bits (512 words): W0.00 to W511.15 (W0 to W511)<br>CIO Area: 37,504 bits (2,344 words): CIO 3800.00 to CIO 6143.15 (CIO 3800 to CIO 6143)  |   |  |                  |
| TR Area                                     | 16 bits: TR0 to TR15   |   |  |                  |
| Holding Area                                | 8,192 bits (512 words): H0.00 to H511.15 (H0 to H511)  |   |  |                  |
| AR Area                                     | Read-only (Write-prohibited): 7168 bits (448 words): A0.00 to A447.15 (A0 to A447)<br>Read/Write: 8192 bits (512 words): A448.00 to A959.15 (A448 to A959)   |   |  |                  |
| Timers                                      | 4,096 bits: T0 to T4095  |   |  |                  |
| Counters                                    | 4,096 bits: C0 to C4095  |   |  |                  |
| DM Area                                     | 32 Kwords: D0 to D32767  |   |  |                  |
| Data Register Area                          | 16 registers (16 bits): DR0 to DR15  |   |  |                  |
| Index Register Area                         | 16 registers (32 bits): IR0 to IR15  |   |  |                  |
| Task Flag Area                              | 32 flags (32 bits): TK0000 to TK0031   |   |  |                  |
| Trace Memory                                | 4,000 words (500 samples for the trace data maximum of 31 bits and 6 words.)   |   |  |                  |
| Memory Cassette                             | A special Memory Cassette (CP1W-ME05M) can be mounted.<br>Note: Can be used for program backups and auto-booting.  |   |  |                  |
| Clock function                              | Supported. Accuracy (monthly deviation): -4.5 min to -0.5 min (ambient temperature: 55°C),<br>-2.0 min to +2.0 min (ambient temperature: 25°C), -2.5 min to +1.5 min (ambient temperature: 0°C)  |   |  |                  |
| Communications functions                    | One built-in peripheral port (USB 1.1): For connecting Support Software only.  |   |  |                  |
|   | A maximum of two Serial Communications Option Boards can be mounted.   |   |  |                  |
|   | A maximum of two Ethernet Option Boards can be mounted. When using CP1W-CIF41 Ver.1.0, one Ethernet Option Board can be mounted.   |   |  |                  |
| Memory backup                               | Flash memory: User programs, parameters (such as the PLC Setup), comment data, and the entire DM Area can be saved to flash memory as initial values.<br>Battery backup: The Holding Area, DM Area, and counter values (flags, PV) are backed up by a battery. |   |  |                  |
| Battery service life                        | 5 years at 25°C. (Use the replacement battery within two years of manufacture.)  |   |  |                  |
| Built-in input terminals                    | 40 (24 inputs, 16 outputs)   | 20 (12 inputs, 8 outputs)<br>Line-driver inputs: Two axes for phases A, B, and Z<br>Line-driver outputs: Two axes for CW and CCW  |  |                  |
| Number of connectable Expansion (I/O) Units | CP Expansion I/O Units: 7 max.; CJ-series Special I/O Units or CPU Bus Units: 2 max.   |   |  |                  |
| Max. number of I/O points                   | 320 (40 built in + 40 per Expansion (I/O) Unit × 7 Units)  | 300 (20 built in + 40 per Expansion (I/O) Unit × 7 Units)   |  |                  |
| Interrupt inputs                            | 8 inputs (Shared by the external interrupt inputs (counter mode) and the quick-response inputs.)   | 6 inputs (Shared by the external interrupt inputs (counter mode) and the quick-response inputs.)  |  |                  |
| Interrupt input counter mode                | 8 inputs (Response frequency: 5 kHz max. for all interrupt inputs),<br>16 bits<br>Up or down counters  | 6 inputs (Response frequency: 5 kHz max. for all interrupt inputs),<br>16 bits<br>Up or down counters   |  |                  |
| Quick-response inputs                       | 8 points (Min. input pulse width: 50 μs max.)  | 6 points (Min. input pulse width: 50 μs max.)   |  |                  |
| Scheduled interrupts                        | 1  |   |  |                  |



| Type   |                      | CP1H-XA CPU Units   | CP1H-X CPU Units | CP1H-Y CPU Units  |
|--|----------------------|---|------------------|---|
| Item   | Models               | CP1H-XA□□□-□  | CP1H-X□□□-□      | CP1H-Y□□□-□   |
| <b>High-speed counters</b>                                 |                      | 4 inputs: Differential phases (4x), 50 kHz or Single-phase (pulse plus direction, up/down, increment), 100 kHz<br>Value range: 32 bits, Linear mode or ring mode<br>Interrupts: Target value comparison or range comparison |                  | 2 inputs: Differential phases (4x), 500 kHz or Single-phase, 1 MHz and<br>2 inputs: Differential phases (4x), 50 kHz or Single-phase (pulse plus direction, up/down, increment), 100 kHz<br>Value range: 32 bits, Linear mode or ring mode<br>Interrupts: Target value comparison or range comparison |
| <b>Pulse outputs (models with transistor outputs only)</b> | <b>Pulse outputs</b> | Trapezoidal or S-curve acceleration and deceleration (Duty ratio: 50% fixed)<br>4 outputs, 1 Hz to 100 kHz (CCW/CW or pulse plus direction)   |                  | Trapezoidal or S-curve acceleration and deceleration (Duty ratio: 50% fixed)<br>2 outputs, 1 Hz to 1 MHz (CCW/CW or pulse plus direction)<br>2 outputs, 1 Hz to 100 kHz (CCW/CW or pulse plus direction)  |
|  | <b>PWM outputs</b>   | Duty ratio: 0.0% to 100.0% (Unit: 0.1%)<br>2 outputs, 0.1 to 6553.5 Hz (Accuracy: ±5% at 1 kHz)   |                  |   |
| <b>Built-in analog I/O terminals</b>                       |                      | 4 analog inputs and 2 analog outputs  | None             |   |
| <b>Analog control</b>                                      |                      | 1 (Setting range: 0 to 255)   |                  |   |
| <b>External analog input</b>                               |                      | 1 input (Resolution: 1/256, Input range: 0 to 10 V), not isolated   |                  |   |

**Note:** The memory areas for CJ-series Special I/O Units and CPU Bus Units are allocated at the same as for the CJ-series. For details, refer to the CJ Series catalog (Cat. No. P052).

# CP1H

## Built-in Inputs / Built-in Outputs

### Terminal Block Arrangement

#### ● CP1H-XA and X CPU Units with AC Power Supply

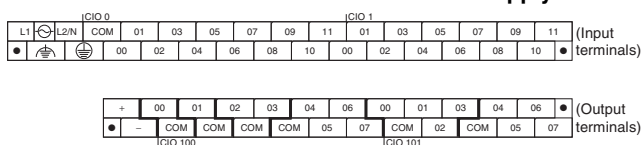

#### ● CP1H-XA and X CPU Units with DC Power supply

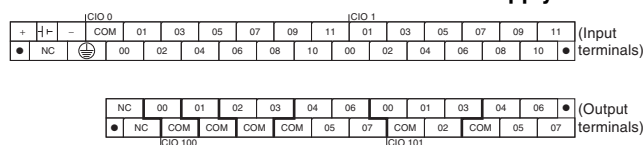

### Built-in Input Area

#### ● CP1H-XA and X CPU Units

| PLC Setup | Input operation |                  |                       | High-speed counter operation | Pulse output origin search function set to be used.                                   |
|-----------|-----------------|------------------|-----------------------|------------------------------|---|
|           | Normal inputs   | Interrupt inputs | Quick-response inputs | High-speed counters          | Origin search   |
| CIO 0     | 00              | Normal input 0   | Interrupt input 0     | Quick-response input 0       | Pulse 0: Origin input signal  |
|           | 01              | Normal input 1   | Interrupt input 1     | Quick-response input 1       | High-speed counter 2 (phase-Z/reset)<br>Pulse 0: Origin proximity input signal        |
|           | 02              | Normal input 2   | Interrupt input 2     | Quick-response input 2       | High-speed counter 1 (phase-Z/reset)<br>Pulse output 1: Origin input signal           |
|           | 03              | Normal input 3   | Interrupt input 3     | Quick-response input 3       | High-speed counter 0 (phase-Z/reset)<br>Pulse output 1: Origin proximity input signal |
|           | 04              | Normal input 4   |                       |                              | High-speed counter 2 (phase-A, increment, or count input)                             |
|           | 05              | Normal input 5   |                       |                              | High-speed counter 2 (phase-B, decrement, or direction input)                         |
|           | 06              | Normal input 6   |                       |                              | High-speed counter 1 (phase-A, increment, or count input)                             |
|           | 07              | Normal input 7   |                       |                              | High-speed counter 1 (phase-B, decrement, or direction input)                         |
|           | 08              | Normal input 8   |                       |                              | High-speed counter 0 (phase-A, increment, or count input)                             |
|           | 09              | Normal input 9   |                       |                              | High-speed counter 0 (phase-B, decrement, or direction input)                         |
|           | 10              | Normal input 10  |                       |                              | High-speed counter 3 (phase-A, increment, or count input)                             |
| CIO 1     | 00              | Normal input 12  | Interrupt input 4     | Quick-response input 4       | High-speed counter 3 (phase-Z/reset)<br>Pulse output 2: Origin input signal           |
|           | 01              | Normal input 13  | Interrupt input 5     | Quick-response input 5       | Pulse output 2: Origin proximity input signal   |
|           | 02              | Normal input 14  | Interrupt input 6     | Quick-response input 6       | Pulse output 3: Origin input signal   |
|           | 03              | Normal input 15  | Interrupt input 7     | Quick-response input 7       | Pulse output 3: Origin proximity input signal   |
|           | 04              | Normal input 16  |                       |                              |   |
|           | 05              | Normal input 17  |                       |                              |   |
|           | 06              | Normal input 18  |                       |                              |   |
|           | 07              | Normal input 19  |                       |                              |   |
|           | 08              | Normal input 20  |                       |                              |   |
|           | 09              | Normal input 21  |                       |                              |   |
|           | 10              | Normal input 22  |                       |                              |   |
|           | 11              | Normal input 23  |                       |                              |   |

### Built-in Output Area

#### ● CP1H-XA and CP1H-X CPU Units

| Instructions | When the instructions to the right are not executed | When a pulse output instruction (SPED, ACC, PLS2, or ORG) is executed |                                | When the origin search function is set to be used in the PLC Setup, and an origin search is executed by the ORG instruction | When the PWM instruction is executed         |            |
|--------------|---|---|--------------------------------|---|--|------------|
|              |   | CW/CCW  | Pulse plus direction           | When the origin search function is used   | PWM output                                   |            |
| PLC Setup    | Normal outputs                                      |   | Fixed duty ratio pulse outputs |   | Variable duty ratio pulse output             |            |
|              |   |   | CW/CCW                         | Pulse plus direction  | When the origin search function is used      | PWM output |
|              | CIO 100   | 00  | Normal output 0                | Pulse output 0 (CW)   | Pulse output 0 (pulse)                       |            |
|              |   | 01  | Normal output 1                | Pulse output 0 (CCW)  | Pulse output 1 (pulse)                       |            |
|              |   | 02  | Normal output 2                | Pulse output 1 (CW)   | Pulse output 0 (direction)                   |            |
|              |   | 03  | Normal output 3                | Pulse output 1 (CCW)  | Pulse output 1 (direction)                   |            |
|              |   | 04  | Normal output 4                | Pulse output 2 (CW)   | Pulse output 2 (pulse)                       |            |
|              |   | 05  | Normal output 5                | Pulse output 2 (CCW)  | Pulse output 2 (direction)                   |            |
| 06           |   | Normal output 6   | Pulse output 3 (CW)            | Pulse output 3 (pulse)  |  |            |
| 07           | Normal output 7                                     | Pulse output 3 (CCW)  | Pulse output 3 (direction)     |   |  |            |
| CIO 101      | 00  | Normal output 8   |                                |   | PWM output 0                                 |            |
|              | 01  | Normal output 9   |                                |   | PWM output 1                                 |            |
|              | 02  | Normal output 10  |                                |   | Origin search 0 (Error counter reset output) |            |
|              | 03  | Normal output 11  |                                |   | Origin search 1 (Error counter reset output) |            |
|              | 04  | Normal output 12  |                                |   | Origin search 2 (Error counter reset output) |            |
| CIO 101      | 05  | Normal output 13  |                                |   | Origin search 3 (Error counter reset output) |            |
|              | 06  | Normal output 14  |                                |   |  |            |
| 07           | Normal output 15                                    |   |                                |   |  |            |

■ Terminal Block Arrangement

● CP1H-Y CPU Units

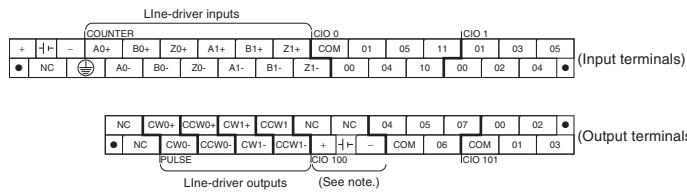

Note: Supply 24 VDC to the bottom 24 VDC input terminals when using bits 04 to 07 of output word CIO 100.

■ Built-in Input Area

● CP1H-Y CPU Units

| PLC Setup | Input operation setting |                  |                       |   | High-speed counter operation setting                          | Pulse output origin search function set to be used. |
|-----------|-------------------------|------------------|-----------------------|---|---|---|
|           | Normal inputs           | Interrupt inputs | Quick-response inputs | High-speed counters   |   | Origin search                                       |
| A0        |                         |                  |                       | High-speed counter 0 (phase-A, increment, or count input) fixed     |   |   |
| B0        |                         |                  |                       | High-speed counter 0 (phase-B, decrement, or direction input) fixed |   |   |
| Z0        |                         |                  |                       | High-speed counter 0 (phase-Z/reset) fixed                          |   | Pulse 0: Origin input signal (line driver)          |
| A1        |                         |                  |                       | High-speed counter 1 (phase-A, increment, or count input) fixed     |   |   |
| B1        |                         |                  |                       | High-speed counter 1 (phase-B, decrement, or direction input) fixed |   |   |
| Z1        |                         |                  |                       | High-speed counter 1 (phase-Z/reset) fixed                          |   | Pulse 1: Origin input signal (line driver)          |
| CIO 0     | Bit 00                  | Normal input 0   | Interrupt 0           | Quick-response input 0  |   | Pulse 2: Origin proximity input signal              |
|           | Bit 01                  | Normal input 1   | Interrupt 1           | Quick-response input 1  | High-speed counter 2 (phase-Z/reset)                          |   |
|           | Bit 04                  | Normal input 2   |                       |   | High-speed counter 2 (phase-A, increment, or count input)     |   |
|           | Bit 05                  | Normal input 3   |                       |   | High-speed counter 2 (phase-B, decrement, or direction input) |   |
|           | Bit 10                  | Normal input 4   |                       |   | High-speed counter 3 (phase-A, increment, or count input)     |   |
|           | Bit 11                  | Normal input 5   |                       |   | High-speed counter 2 (phase-B, decrement, or direction input) | Pulse 3: Origin proximity input signal              |
| CIO 1     | Bit 00                  | Normal input 6   | Interrupt 2           | Quick-response input 2  | High-speed counter 2 (phase-Z/reset)                          | Pulse 3: Origin input signal                        |
|           | Bit 01                  | Normal input 7   | Interrupt 3           | Quick-response input 3  |   | Pulse 2: Origin input signal                        |
|           | Bit 02                  | Normal input 8   | Interrupt 4           | Quick-response input 4  |   | Pulse 1: Origin input signal (open collector)       |
|           | Bit 03                  | Normal input 9   | Interrupt 5           | Quick-response input 5  |   | Pulse 0: Origin input signal (open collector)       |
|           | Bit 04                  | Normal input 10  |                       |   |   | Pulse 1: Origin proximity input signal              |
|           | Bit 05                  | Normal input 11  |                       |   |   | Pulse 0: Origin proximity input signal              |

These areas are for line-driver inputs, so they can be used only for high-speed counters (1 MHz) and not for other purposes, such as normal inputs.

■ Built-in Output Area

● CP1H-Y CPU Units

| Instructions | When the instructions to the right are not executed | When a pulse output instruction (SPED, ACC, PLS2, or ORG) is executed | When the origin search function is set to be used in the PLC Setup, and an origin search is executed by the ORG instruction |  | When the PWM instruction is executed |
|--------------|---|---|---|--|--------------------------------------|
|              |   | Fixed duty ratio pulse output   |   |  | Variable duty ratio pulse output     |
| PLC Setup    | Normal output                                       | CW/CCW  | Pulse plus direction  | When the origin search function is used      | PWM output                           |
| CW0          | Not supported.                                      | Pulse output 0 (CW) fixed   | Pulse output 0 (pulse) fixed  |  |                                      |
| CCW0         | Not supported.                                      | Pulse output 0 (CCW) fixed  | Pulse output 1 (pulse) fixed  |  |                                      |
| CW1          | Not supported.                                      | Pulse output 1 (CW) fixed   | Pulse output 0 (direction) fixed  |  |                                      |
| CCW1         | Not supported.                                      | Pulse output 1 (CCW) fixed  | Pulse output 1 (direction) fixed  |  |                                      |
| CIO 100      | Bit 04  | 100.04  | Pulse output 2 (CW)   | Pulse output 2 (pulse)                       |                                      |
|              | Bit 05  | 100.05  | Pulse output 2 (CCW)  | Pulse output 2 (direction)                   |                                      |
|              | Bit 06  | 100.06  | Pulse output 3 (CW)   | Pulse output 3 (pulse)                       |                                      |
|              | Bit 07  | 100.07  | Pulse output 3 (CCW)  | Pulse output 3 (direction)                   |                                      |
| CIO 101      | Bit 00  | 101.00  |   | Origin search 2 (Error counter reset output) | PWM output 0                         |
|              | Bit 01  | 101.01  |   | Origin search 3 (Error counter reset output) | PWM output 1                         |
|              | Bit 02  | 101.02  |   | Origin search 0 (Error counter reset output) |                                      |
|              | Bit 03  | 101.03  |   | Origin search 1 (Error counter reset output) |                                      |

These areas are for line-driver inputs, so they can be used only for high-speed counters (1 MHz) and not for other purposes, such as normal inputs.

# CP1H

## I/O Specifications for CPU Units

### Input Specifications

| ITEM                  | Specifications                             |   |                      |
|-----------------------|--|---|----------------------|
|                       | High-speed counter inputs (phases A and B) | Interrupt inputs and quick-response inputs    | Normal inputs        |
| CP1H-XA/X CPU Units   | CIO 0.04 to CIO 0.11                       | CIO 0.00 to CIO 0.03 and CIO 1.00 to CIO 1.03 | CIO 1.04 to CIO 1.11 |
| CP1H-Y CPU Units      | CIO 0.04, CIO 0.05, CIO 0.10, CIO 0.11     | CIO 0.00, CIO 0.01 and CIO 1.00 to CIO 1.03   | CIO 1.04, CIO 1.05   |
| Input voltage         | 24 VDC +10%/−15%                           |   |                      |
| Applicable sensors    | 2-wire sensors or 3-wire sensors           |   |                      |
| Input impedance       | 3.0 kΩ                                     |   | 4.7 kΩ               |
| Input current         | 7.5 mA typical                             |   | 5 mA typical         |
| ON voltage            | 17.0 VDC min.                              |   | 14.4 VDC min.        |
| OFF voltage/current   | 1 mA max. at 5.0 VDC                       |   |                      |
| ON delay              | 2.5 μs max.                                | 50 μs max.                                    | 1 ms max.            |
| OFF delay             | 2.5 μs max.                                | 50 μs max.                                    | 1 ms max.            |
| Circuit configuration |  |   |                      |

### High-speed Counter Function Input Specifications

CP1H-XA/X CPU Units (Input bits: CIO 0.04 to CIO 0.11)  
 CP1H-Y CPU Units (Input bits: CIO 0.04, CIO 0.05, CIO 0.10, CIO 0.11)

| Item         | Specifications  |
|--------------|---|
| ON/OFF delay | <ul style="list-style-type: none"> <li>Pulse plus direction input mode</li> <li>Increment mode</li> <li>Up/down input mode</li> </ul> <ul style="list-style-type: none"> <li>Differential phase input mode</li> </ul> |

### Interrupt Input Counter Mode

CP1H-XA/X CPU Units (Input bits: CIO 0.00 to CIO 0.03, CIO 1.00 to CIO 1.03)  
 CP1H-Y CPU Units (Input bits: CIO 0.00, CIO 0.11, CIO 1.00 to CIO 1.03)

| Item         | Specifications |
|--------------|----------------|
| ON/OFF delay |                |

### High-speed Counter Inputs (Line-driver Inputs)

CP1H-Y CPU Units

| Item                      | Specifications   |
|---------------------------|--|
| High-speed counter inputs | Phases A and B <span style="float: right;">Phase Z</span>  |
| Input voltage             | RS-422A line-driver, AM26LS31 or equivalent<br>Note: The power supply voltage on the line-driver must be 5 V±5% max.   |
| Input type                | Line-driver input  |
| Input current             | 10 mA typical <span style="float: right;">13 mA typical</span>   |
| Circuit configuration     |  |
| ON/OFF delay              | <ul style="list-style-type: none"> <li>Pulse plus direction input mode</li> <li>Increment mode</li> <li>Up/down input mode</li> </ul> <ul style="list-style-type: none"> <li>Differential phase input mode</li> </ul> <span style="float: right;"> </span> |

■ Output Specifications

● CPU Units with Relay Outputs

| Item                    |            | Specifications                                  |   |
|-------------------------|------------|---|---|
| Max. switching capacity |            | 2 A, 250 VAC (cosφ = 1), 2 A, 24 VDC 4 A/common |   |
| Min. switching capacity |            | 5 VDC, 10 mA                                    |   |
| Service life of relay   | Electrical | Resistive load                                  | 100,000 operations (24 VDC)             |
|                         |            | Inductive load                                  | 48,000 operations (250 VAC, cosφ = 0.4) |
|                         | Mechanical |   | 20,000,000 operations                   |
| ON delay                |            | 15 ms max.                                      |   |
| OFF delay               |            | 15 ms max.                                      |   |
| Circuit configuration   |            |   |   |

**Note:** Under the worst conditions, the service life of output contacts is as shown on the left.  
The service life of relays is as shown in the following diagram as a guideline.

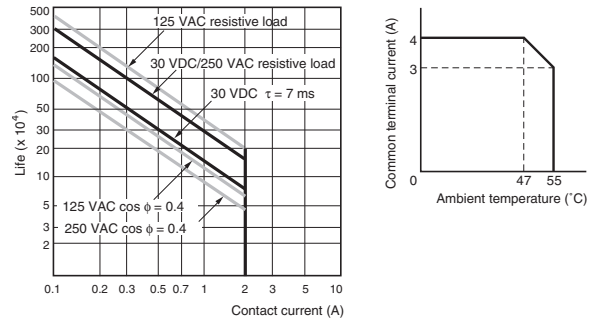

● CPU Units with Transistor Outputs (Sinking/Sourcing)

| Item                    | Specifications   |                          |  |                          |
|-------------------------|--|--------------------------|--|--------------------------|
|                         | CP1H-XA/X CPU Units  | CIO 100.00 to CIO 100.07 | CIO 101.00, CIO 101.01                         | CIO 101.02 to CIO 101.07 |
| CP1H-Y CPU Units        | CIO 100.04 to CIO 100.07                                   | CIO 101.00, CIO 101.01   | CIO 101.02, CIO 101.03                         |                          |
| Max. switching capacity | 4.5 to 30 VDC: 300 mA/point, 0.9 A/common, 3.6 A/Unit *1*2 |                          |  |                          |
| Min. switching capacity | 4.5 to 30 VDC, 1 mA  |                          |  |                          |
| Leakage current         | 0.1 mA max.  |                          |  |                          |
| Residual voltage        | 0.6 V max.   |                          | 1.5 V max.                                     |                          |
| ON delay                | 0.1 ms max.  |                          |  |                          |
| OFF delay               | 0.1 ms max.  |                          | 1 ms max.                                      |                          |
| Fuse                    | 1/common *3  |                          |  |                          |
| Circuit configuration   | <p>Sinking Outputs</p> <p>Sourcing Outputs</p>             |                          | <p>Sinking Outputs</p> <p>Sourcing Outputs</p> |                          |

**Note: 1.** Do not apply a voltage or connect a load to an output terminal exceeding the maximum switching capacity.

- \*1 Also do not exceed 0.9 A for the total for CIO 100.00 to CIO 100.03. (CIO 100.00 to CIO 100.03 is different common.)
- \*2 A maximum of 0.9 A per common can be switched at an ambient temperature of 50 °C.
- \*3 Fuses cannot be replaced by the user.

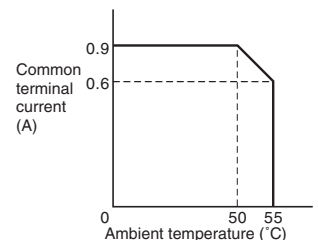

# CP1H

## ● Pulse outputs

CP1H-XA/X CPU Units: Output bits CIO 100.00 to CIO 100.07  
 CP1H-Y CPU Units: Output bits CIO100.04 to CIO 100.07

| Item                    | Specifications            |
|-------------------------|---------------------------|
| Max. switching capacity | 30 mA at 4.75 to 26.4 VDC |
| Min. switching capacity | 7 mA at 4.75 to 26.4 VDC  |
| Max. output frequency   | 100 kHz                   |
| Output waveform         |                           |

- Note:**
1. The above values assume a resistive load and do not consider the impedance of the cable connecting the load.
  2. The pulse widths during actual use may be smaller than the ones shown above due to pulse distortion caused by connecting cable impedance.
  3. The OFF and ON refer to the output transistor. The output transistor is ON at level "L".

## ● Pulse Outputs (Line-driver Outputs)

CP1H-Y CPU Units

| Item                  | Specifications                              |
|-----------------------|---|
| Pulse outputs         | Line-driver outputs, Am26LS31 or equivalent |
| Max. output current   | 20 mA                                       |
| Max. output frequency | 1 MHz                                       |
| Circuit configuration |   |

**Note:** Connect a load of 20 mA or less to the output. The Unit may be damaged if a current of more than 20 mA is output.

## ■ Analog I/O Specifications (CP1H-XA CPU Units Only)

| Item                  |   | Voltage I/O  | Current I/O  |
|-----------------------|---|--|--|
| Analog Input Section  | Number of analog inputs   | 4  |  |
|                       | Input signal range  | 0 to 5 V, 1 to 5 V, 0 to 10 V, or -10 to 10 V  | 0 to 20 mA or 4 to 20 mA                           |
|                       | Max. rated input  | ±15 V  | ±30 mA   |
|                       | External input impedance  | 1 MΩ min.  | Approx. 250 Ω                                      |
|                       | Resolution  | 1/6,000 or 1/12,000 (full scale)   |  |
|                       | Overall accuracy  | 25°C: ±0.3% full scale/0 to 55°C: ±0.6% full scale   | 25°C: ±0.4% full scale/0 to 55°C: ±0.8% full scale |
|                       | A/D conversion data   | Full scale for -10 to 10 V: F448 (E890) to 0BB8 (1770) hex<br>Full scale for other ranges: 0000 to 1770 (2EE0) hex |  |
|                       | Averaging   | Supported (Set for individual inputs in the PLC Setup.)  |  |
|                       | Open-circuit detection  | Supported (Value when disconnected: 8000 Hex)  |  |
| Analog Output Section | Number of outputs   | 2  |  |
|                       | Output signal range   | 0 to 5 V, 1 to 5 V, 0 to 10 V, -10 to 10 V   | 0 to 20 mA or 4 to 20 mA                           |
|                       | Allowable external output load resistance   | 1 kΩ min.  | 600 Ω max.   |
|                       | External output impedance   | 0.5 Ω max.   | ---  |
|                       | Resolution  | 1/6000 or 1/12000 (full scale)   |  |
|                       | Overall accuracy  | 25°C±0.4% of full scale, 0 to 55°C±0.8% of full scale  |  |
| D/A conversion data   | Full scale for -10 to 10 V: F448 (E890) to 0BB8 (1770) hex<br>Full scale for other ranges: 0000 to 1770 (2EE0) hex  |  |  |
| Conversion time       | 1 ms/point  |  |  |
| Isolation method      | Photocoupler isolation between analog I/O terminals and internal circuits. No isolation between analog I/O signals. |  |  |

### Built-in Analog Input Switch (Factory Settings)

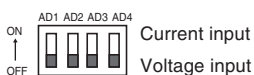

## ● Pulse outputs

CP1H-XA/X/Y CPU Units: Output bits CIO101.00, CIO 101.01

| Item                    | Specifications                                |
|-------------------------|---|
| Max. switching capacity | 30 mA at 4.75 to 26.4 VDC                     |
| Max. output frequency   | 1 kHz   |
| PWM output precision    | ON duty +5%, -0% at output frequency of 1 kHz |
| Output waveform         |   |

- Note:**
1. The above values assume a resistive load and do not consider the impedance of the cable connecting the load.
  2. The pulse widths during actual use may be smaller than the ones shown above due to pulse distortion caused by connecting cable impedance.
  3. The OFF and ON refer to the output transistor. The output transistor is ON at level "L".

### Built-in Analog I/O Terminal Block Arrangement

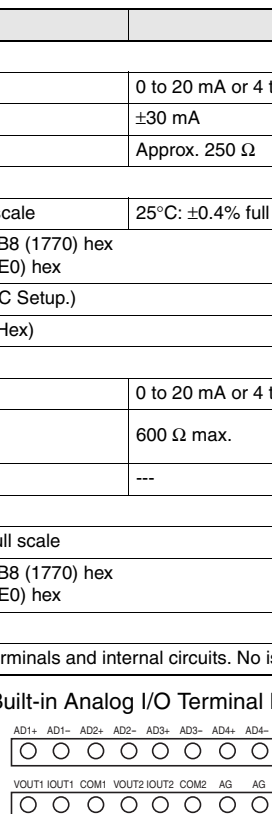

# External Interfaces

## ■ CPU Unit Nomenclature

### ●Front

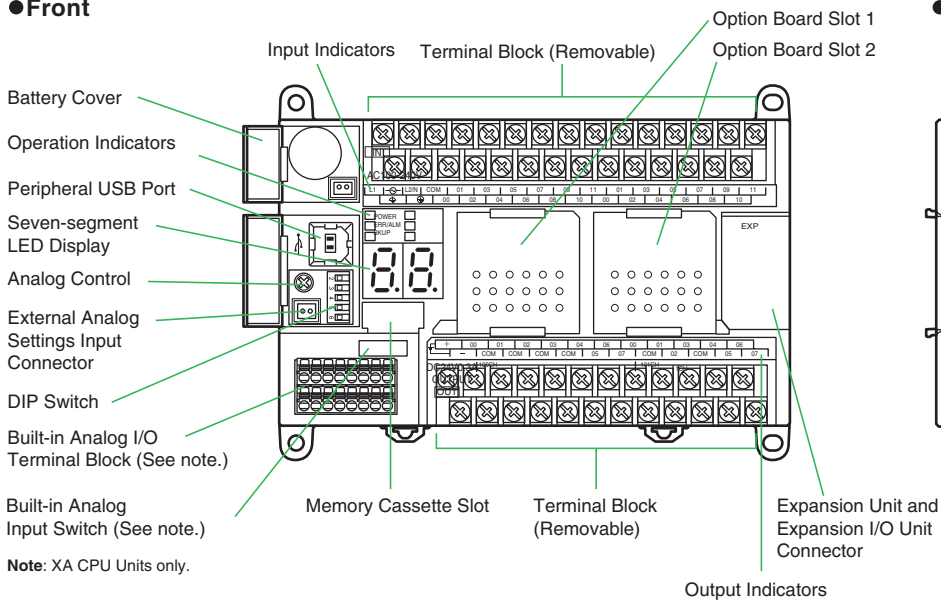

**Note:** XA CPU Units only.

### ●Back

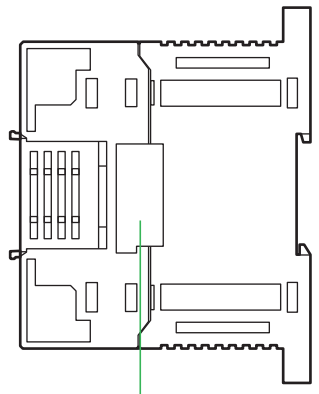



# CP1H

## Option Unit Specifications

### Serial Communications Specifications (CP1W-CIF01/-CIF11)

| Item                                   | Function   | Interface   |
|--|--|---|
| Peripheral USB port                    | For connecting Peripheral Device.  | Conforms to USB 1.1, B-type connector   |
| Serial port 1<br>(Option board slot 1) | Host Link, No-protocol, NT Link (1: N),<br>Serial PLC Link (See note.),<br>Serial Gateway (CompoWay/F master, Modbus-RTU master),<br>Modbus-RTU easy master function,<br>ToolBus | The following can be used for either port.<br><br>CP1W-CIF01 RS-232C Option Board   |
| Serial port 2<br>(Option board slot 2) |  | CP1W-CIF11<br>RS-422A/485 Option Board<br>(Maximum transmission distance 50m)<br><br>CP1W-CIF12<br>RS-422A/485(Isolated-type) Option Board<br>(Maximum transmission distance 500m)<br><br>Can be used with either port. |

Note: Serial PLC Link can be used with either serial port 1 or serial port 2.

### Ethernet Communications Specifications (CP1W-CIF41)

| Item                                | Specifications  |  |            |   |           |
|-------------------------------------|---|--|------------|---|-----------|
| Applicable PLCs                     | CP1H CPU Units  |  |            |   |           |
| Number of Units that can be mounted | 2 sets. (The CP1W-CIF41 Ver.1.0 and Ver.2.0 can be combined and used with one CPU Unit. When using CP1W-CIF41 Ver.1.0, only one unit can be mounted in an option board slot.)                     |  |            |   |           |
| Transfer                            | Media access method   | CSMA/CD  |            |   |           |
|                                     | Modulation method   | Baseband   |            |   |           |
|                                     | Transmission paths  | Star form  |            |   |           |
|                                     | Baud rate   | 100 Mbit/s (100Base-TX), 10 Mbit/s (10Base-T)  |            |   |           |
|                                     | Transmission media  | <table border="0"> <tr> <td>100 Mbit/s</td> <td> <ul style="list-style-type: none"> <li>Unshielded twisted-pair (UDP) cable<br/>Categories: 5, 5e</li> <li>Shielded twisted-pair (STP) cable<br/>Categories: 100 Ω at 5, 5e</li> </ul> </td> </tr> <tr> <td>10 Mbit/s</td> <td> <ul style="list-style-type: none"> <li>Unshielded twisted-pair (UDP) cable<br/>Categories: 3, 4, 5, 5e</li> <li>Shielded twisted-pair (STP) cable<br/>Categories: 100 Ω at 3, 4, 5, 5e</li> </ul> </td> </tr> </table> | 100 Mbit/s | <ul style="list-style-type: none"> <li>Unshielded twisted-pair (UDP) cable<br/>Categories: 5, 5e</li> <li>Shielded twisted-pair (STP) cable<br/>Categories: 100 Ω at 5, 5e</li> </ul> | 10 Mbit/s |
| 100 Mbit/s                          | <ul style="list-style-type: none"> <li>Unshielded twisted-pair (UDP) cable<br/>Categories: 5, 5e</li> <li>Shielded twisted-pair (STP) cable<br/>Categories: 100 Ω at 5, 5e</li> </ul>             |  |            |   |           |
| 10 Mbit/s                           | <ul style="list-style-type: none"> <li>Unshielded twisted-pair (UDP) cable<br/>Categories: 3, 4, 5, 5e</li> <li>Shielded twisted-pair (STP) cable<br/>Categories: 100 Ω at 3, 4, 5, 5e</li> </ul> |  |            |   |           |
| Transmission Distance               | 100 m (distance between hub and node)   |  |            |   |           |

| Item                    | FINS Communications Service Specifications                               |   |
|-------------------------|--|---|
| Number of nodes         | 254  |   |
| Message length          | 1016 bytes max.  |   |
| Size of buffer          | 8k   |   |
| Communications Function | FINS Communications Service (UDP/IP, TCP/IP)                             |   |
| FINS/UDP method         | Protocol used  | UDP/IP  |
|                         | Server/Client  | Only server (Cannot be used as a client)                                      |
|                         | Port number  | 9600 (default) Can be changed.  |
|                         | Protection   | No  |
| FINS/TCP method         | Protocol used  | TCP/IP  |
|                         | Server/Client  | Only server (Cannot be used as a client)                                      |
|                         | Number of connections  | Up to 2 simultaneous connections and only one connection can be set to client |
|                         | Port number  | 9600 (default) Can be changed.  |
| Protection              | Yes (Specification of client IP addresses when unit is used as a server) |   |

- Note: 1. CX-Programmer version 8.1 or higher (CX-One version 3.1 or higher) is required.  
 2. Use CX-Integrator version 2.33 or higher (CX-One version 3.1 or higher) when the system needs to be set the routing tables. However, CX-Integrator does not support the other functions, using CP1W-CIF41, such as transferring the parameters and network structure.  
 3. To connect the CP1H CPUs with the NS-series Programmable Terminals via Ethernet using CP1W-CIF41, make sure that the system version of NS Series is 8.2 or higher.

■ LDC Option Board (CP1W-DAM01)

● Specifications

| Item                         | Function   |
|------------------------------|--|
| Mounting port                | CP1H: Option board slot 1  |
| Communications protocol      | Peripheral bus (Turn ON DIP switch pin 4.)                       |
| Number of display characters | 4 rows × 12 characters: 48 characters max.                       |
| Display characters           | 5 × 7 dots (alphanumeric and symbols).                           |
| Backlight                    | Electroluminescence (EL): Normal: Lit green; Error: Flashing red |

● LCD Functions

| Operation                         | Description  |
|-----------------------------------|--|
| Changing operating modes          | Change the PLC operating mode without using the CX-Programmer.   |
| I/O memory                        | Read and change the present values in the memory areas and force-set or force-reset bits.  |
| PLC Setup operations              | Read and change the PLC Setup.   |
| Analog I/O monitor                | Monitor the analog adjustment and present value for the external analog setting input.   |
| Error log display                 | Read the log of errors that have occurred.   |
| Memory cassette operation         | Transfer and verify user programs between the PLC and memory cassette.   |
| User monitor settings             | Read the status of up to 16 words and bits with comments. You can use this setting to read data on the startup display.  |
| Message display function settings | Display a user-set message of up to 48 characters on the LCD Option Board when a specified bit turns ON. A maximum of 16 screens can be registered for display.  |
| Timers                            | <p><b>Day timer</b></p> <p>Use this timer for ON/OFF switching at a specified times every day from the starting day of the week to the ending day of the week. Sixteen timers can be set from timer 01 to timer 16.</p> <p>Operation:</p>  |
|                                   | <p><b>Weekly timer</b></p> <p>Use this timer for ON/OFF operation in intervals of one week that starts one day and ends another day. Sixteen timers can be set from timer No. 01 to timer No. 16.</p> <p>Operation:</p>  |
|                                   | <p><b>Calendar timer</b></p> <p>Use the calendar timers for ON or OFF operation in intervals of one year from the starting day to the ending day. Sixteen timers can be set from timer 01 to timer 16.</p> <p>Operation:</p>   |
| Saving setting                    | Save the various settings that you set with the LCD Option Board to the DM Area of the PLC. You can also write the settings saved in the PLC to the LCD Option Board.  |
| Language                          | Changing the display language (Japanese/English)   |
| Other functions                   | <ul style="list-style-type: none"> <li>• Setting the time of the PLC's built-in clock</li> <li>• Reading system data (e.g., unit version and lot number)</li> <li>• Setting the backlight lighting time</li> <li>• Adjusting LCD contrast</li> <li>• Reading cycle time (e.g., average, maximum, and minimum)</li> <li>• Clearing data for the LCD Option Board</li> </ul> |

# CP1H

## Expansion I/O Unit Specifications

### ■ CP1W-40EDR/40EDT/40EDT1/32ER/32ET/32ET1/20EDR1/20EDT/20EDT1/16ER/16ET/16ET1/8ED/8ER/8ET/8ET1 Expansion I/O Units

Expansion I/O Units can be connected to the CPU Unit to configure the required number of I/O points.

#### ● DC Inputs (CP1W-40EDR/40EDT/40EDT1/20EDR1/20EDT/20EDT1/8ED)

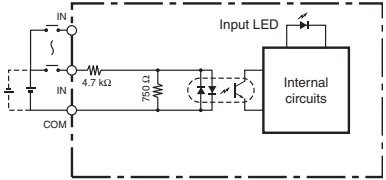
| Item                  | Specifications  |
|-----------------------|---|
| Input voltage         | 24 VDC +10%/-15%  |
| Input impedance       | 4.7 kΩ  |
| Input current         | 5 mA typical  |
| ON voltage            | 14.4 VDC min.   |
| OFF voltage           | 5.0 VDC max.  |
| ON delay              | 0 to 32 ms max. (Default: 8 ms) (See note 1.)                                     |
| OFF delay             | 0 to 32 ms max. (Default: 8 ms) (See note 1.)                                     |
| Circuit configuration |  |

**Note: 1.** Do not apply a voltage exceeding the rated voltage to an input terminal.  
**2.** Can be set in the PLC Setup to 0, 0.5, 1, 2, 4, 8, 16 or 32 ms. The CP1W-40EDR/EDT/EDT1 are fixed at 16 ms.

#### ● Relay Outputs (CP1W-40EDR/32ER/20EDR1/16ER/8ER)

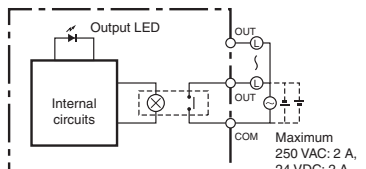
| Item                    | Specifications  |   |
|-------------------------|---|---|
| Max. switching capacity | 2 A, 250 VAC (cosφ = 1), 24 VDC 4 A/common  |   |
| Min. switching capacity | 5 VDC, 10 mA  |   |
| Service life of relay   | Resistive load  | 150,000 operations (24 VDC)             |
|                         | Inductive load  | 100,000 operations (24 VAC cos φ = 0.4) |
|                         | Mechanical  | 20,000,000 operations                   |
| ON delay                | 15 ms max.  |   |
| OFF delay               | 15 ms max.  |   |
| Circuit configuration   |  |   |

**Note:** Under the worst conditions, the service life of output contacts is as shown on the left. The service life of relays is as shown in the following diagram as a guideline.

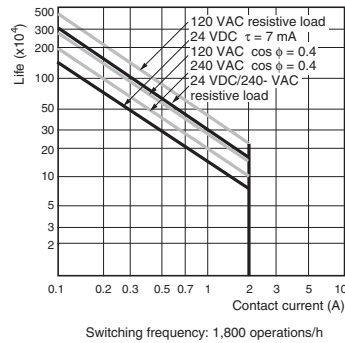

Relationship between Output Load Current and Ambient Temperature (CP1W-16ER/32ER)

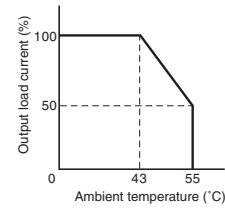

When using the CP1W-32ER, do not allow more than 24 outputs to be ON simultaneously regardless of the ambient temperature.

● Transistor Outputs (Sinking/Sourcing)  
 (CP1W-40EDT/-40EDT1/-32ET/-32ET1/-20EDT/-20EDT1/-16ET/-16ET1/-8ET/-8ET1)

| Item   | Specifications                               |                        |                              |                              |  |
|--|--|------------------------|------------------------------|------------------------------|--|
|  | CP1W-40EDT<br>CP1W-40EDT1                    | CP1W-32E<br>CP1W-32ET1 | CP1W-20EDT<br>CP1W-20EDT1    | CP1W-16ET<br>CP1W-16ET1      | CP1W-8ET<br>CP1W-8ET1  |
| Max. switching capacity (See note 3.)            | 4.5 to 30 VDC: 0.3 A/point                   |                        | 24 VAC +10%/-5%: 0.3 A/point | 4.5 to 30 VDC: 0.3 A/point   | <ul style="list-style-type: none"> <li>OUT00/01<br/>4.5 to 30 VDC, 0.2 A/output</li> <li>OUT02 to 07<br/>4.5 to 30 VDC, 0.3A/output</li> </ul> |
|  | 0.9 A/common<br>3.6 A/common                 |                        | 0.9 A/common<br>1.8 A/common | 0.9 A/common<br>3.6 A/common | 0.9 A/common<br>1.8 A/common   |
| Leakage current                                  | 0.1 mA max.                                  |                        |                              |                              |  |
| Residual voltage                                 | 1.5 V max.                                   |                        |                              |                              |  |
| ON delay   | 0.1ms max.                                   |                        |                              |                              |  |
| OFF delay  | 1 ms max. at 24 VDC<br>+10%/-5%, 5 to 300 mA |                        |                              |                              |  |
| Max number of Simultaneously ON Points of Output | 16 pts (100%)                                | 24 pts (75%)           | 8 pts (100%)                 | 16 pts (100%)                | 8 pts (100%)   |
| Fuse (See note 2.)                               | 1/common                                     |                        |                              |                              |  |
| Circuit configuration                            | Sinking Outputs                              |                        | Sourcing Outputs             |                              |  |
|  |  |                        |                              |                              |  |

- Note:**
1. Do not apply a voltage or connect a load to an output terminal exceeding the maximum switching capacity.
  2. The fuses cannot be replaced by the user.
  3. A maximum of 0.9 A per common can be switched at an ambient temperature of 50°C.

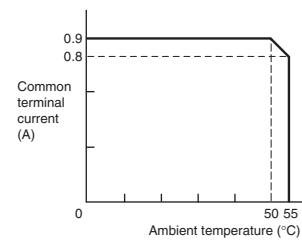

## ■ CP1W-AD041/AD042/DA021/DA041/DA042/MAD11/MAD42/MAD44 Analog Units

Analog values that are input are converted to binary data and stored in the input area, or binary data is output as analog values.

### ● Analog Input Units

| Model                           |           | CP1W-AD041   |                          | CP1W-AD042   |                          |
|---------------------------------|-----------|--|--------------------------|--|--------------------------|
| Item                            |           | Voltage Input  | Current Input            | Voltage Input  | Current Input            |
| Number of inputs                |           | 4 inputs (4 words allocated)   |                          |  |                          |
| Input signal range              |           | 0 to 5 VDC, 1 to 5 VDC, 0 to 10 VDC, or -10 to 10 VDC  | 0 to 20 mA or 4 to 20 mA | 0 to 5 VDC, 1 to 5 VDC, 0 to 10 VDC, or -10 to 10 VDC  | 0 to 20 mA or 4 to 20 mA |
| Max. rated input                |           | ±15 V  | ±30 mA                   | ±15 V  | ±30 mA                   |
| External input impedance        |           | 1 MΩ min.  | Approx. 250 Ω            | 1 MΩ min.  | Approx. 250 Ω            |
| Resolution                      |           | 1/6000 (full scale)  |                          | 1/12000 (full scale)   |                          |
| Overall accuracy                | 25°C      | 0.3% full scale  | 0.4% full scale          | 0.2% full scale  | 0.3% full scale          |
|                                 | 0 to 55°C | 0.6% full scale  | 0.8% full scale          | 0.5% full scale  | 0.7% full scale          |
| A/D conversion data             |           | 16-bit binary (4-digit hexadecimal)<br>Full scale for -10 to 10 V: F448 to 0BB8 Hex<br>Full scale for other ranges: 0000 to 1770 Hex |                          | 16-bit binary (4-digit hexadecimal)<br>Full scale for -10 to 10 V: E890 to 1770 Hex<br>Full scale for other ranges: 0000 to 2EE0 Hex |                          |
| Averaging function              |           | Supported (Set in output words n+1 and n+2.)   |                          |  |                          |
| Open-circuit detection function |           | Supported  |                          |  |                          |
| Conversion time                 |           | 2 ms/point (8 ms/all points)   |                          | 1 ms/point (4 ms/all points)   |                          |
| Isolation method                |           | Photocoupler isolation between analog I/O terminals and internal circuits. No isolation between analog I/O signals.                  |                          |  |                          |
| Current consumption             |           | 5 VDC: 100 mA max.; 24 VDC: 90 mA max.   |                          | 5 VDC: 100 mA max.; 24 VDC: 50 mA max.   |                          |

### ● Analog Output Units

| Model                 |   | CP1W-DA021/CP1W-DA041  |                          | CP1W-DA042   |                          |  |
|-----------------------|---|--|--------------------------|--|--------------------------|--|
| Item                  |   | Voltage Output   | Current Output           | Voltage Output   | Current Output           |  |
| Analog output section | Number of outputs                         | CP1W-DA021: 2 outputs (2 words allocated)<br>CP1W-DA041: 4 outputs (4 words allocated)   |                          | 4 outputs (4 words allocated)  |                          |  |
|                       | Output signal range                       | 1 to 5 VDC, 0 to 10 VDC, or -10 to 10 VDC  | 0 to 20 mA or 4 to 20 mA | 1 to 5 VDC, 0 to 10 VDC, or -10 to 10 VDC  | 0 to 20 mA or 4 to 20 mA |  |
|                       | External output allowable load resistance | 2 kΩ min.  | 350 Ω max.               | 2 kΩ min.  | 350 Ω max.               |  |
|                       | External output impedance                 | 0.5 Ω max.   | ---                      | 0.5 Ω max.   | ---                      |  |
|                       | Resolution                                | 1/6000 (full scale)  |                          | 1/12000 (full scale)   |                          |  |
|                       | Overall accuracy                          | 25°C   | 0.4% full scale          |  | 0.3% full scale          |  |
|                       |   | 0 to 55°C  | 0.8% full scale          |  | 0.7% full scale          |  |
| D/A conversion data   |   | 16-bit binary (4-digit hexadecimal)<br>Full scale for -10 to 10 V: F448 to 0BB8 Hex<br>Full scale for other ranges: 0000 to 1770 Hex |                          | 16-bit binary (4-digit hexadecimal)<br>Full scale for -10 to 10 V: E890 to 1770 Hex<br>Full scale for other ranges: 0000 to 2EE0 Hex |                          |  |
| Conversion time       |   | CP1W-DA021: 2 ms/point (4 ms/all points)<br>CP1W-DA041: 2 ms/point (8 ms/all points)   |                          | 1 ms/point (4 ms/all points)   |                          |  |
| Isolation method      |   | Photocoupler isolation between analog I/O terminals and internal circuits. No isolation between analog I/O signals.                  |                          |  |                          |  |
| Current consumption   |   | CP1W-DA021: 5 VDC: 40 mA max.; 24 VDC: 95 mA max.<br>CP1W-DA041: 5 VDC: 80 mA max.; 24 VDC: 124 mA max.                              |                          | 5 VDC: 70 mA max.; 24 VDC: 160 mA max.   |                          |  |

## ● Analog I/O Units

| Model                           |  | CP1W-MAD42/CP1W-MAD44  |  | CP1W-MAD11   |                          |                 |
|---------------------------------|--|--|--|--|--------------------------|-----------------|
| Item                            |  | Voltage I/O  | Current I/O  | Voltage I/O  | Current I/O              |                 |
| Analog Input Section            | Number of inputs   | 4 inputs (4 words allocated)   |  | 2 inputs (2 words allocated)   |                          |                 |
|                                 | Input signal range   | 0 to 5 VDC, 1 to 5 VDC, 0 to 10 VDC, or -10 to 10 VDC  | 0 to 20 mA or 4 to 20 mA   | 0 to 5 VDC, 1 to 5 VDC, 0 to 10 VDC, or -10 to 10 VDC  | 0 to 20 mA or 4 to 20 mA |                 |
|                                 | Max. rated input   | ±15 V  | ±30 mA   | ±15 V  | ±30 mA                   |                 |
|                                 | External input impedance   | 1 MΩ min.  | Approx. 250 Ω  | 1 MΩ min.  | Approx. 250 Ω            |                 |
|                                 | Resolution   | 1/12000 (full scale)   |  | 1/6000 (full scale)  |                          |                 |
|                                 | Overall accuracy   | 25°C   | 0.2% full scale  | 0.3% full scale  | 0.3% full scale          | 0.4% full scale |
|                                 |  | 0 to 55°C  | 0.5% full scale  | 0.7% full scale  | 0.6% full scale          | 0.8% full scale |
|                                 | A/D conversion data  | 16-bit binary (4-digit hexadecimal)<br>Full scale for -10 to 10 V: E890 to 1770 hex<br>Full scale for other ranges: 0000 to 2EE0 hex |  | 16-bit binary (4-digit hexadecimal)<br>Full scale for -10 to 10 V: F448 to 0BB8 hex<br>Full scale for other ranges: 0000 to 1770 hex |                          |                 |
|                                 | Averaging function   | Supported  |  | Supported (Settable for individual inputs via DIP switch)  |                          |                 |
| Open-circuit detection function | Supported  |  |  |  |                          |                 |
| Analog Output Section           | Number of outputs  | CP1W-MAD42: 2 outputs (2 words allocated)<br>CP1W-MAD44: 4 outputs (4 words allocated)   |  | 1 output (1 word allocated)  |                          |                 |
|                                 | Output signal range  | 1 to 5 VDC, 0 to 10 VDC, or -10 to 10 VDC  | 0 to 20 mA or 4 to 20 mA   | 1 to 5 VDC, 0 to 10 VDC, or -10 to 10 VDC  | 0 to 20 mA or 4 to 20 mA |                 |
|                                 | Allowable external output load resistance  | 2 kΩ min.  | 350 Ω max.   | 1 kΩ min.  | 600 Ω max.               |                 |
|                                 | External output impedance  | 0.5 Ω max.   | ---  | 0.5 Ω max.   | ---                      |                 |
|                                 | Resolution   | 1/12000 (full scale)   |  | 1/6000 (full scale)  |                          |                 |
|                                 | Overall accuracy   | 25°C   | 0.3% full scale  |  | 0.4% full scale          |                 |
|                                 |  | 0 to 55°C  | 0.7% full scale  |  | 0.8% full scale          |                 |
| Set data (D/A conversion)       | 16-bit binary (4-digit hexadecimal)<br>Full scale for -10 to 10 V: E890 to 1770 hex<br>Full scale for other ranges: 0000 to 2EE0 hex |  | 16-bit binary (4-digit hexadecimal)<br>Full scale for -10 to 10 V: F448 to 0BB8 hex<br>Full scale for other ranges: 0000 to 1770 hex |  |                          |                 |
| Conversion time                 | CP1W-MAD42: 1 ms/point (6 ms/all points)<br>CP1W-MAD44: 1 ms/point (8 ms/all points)   |  | 2 ms/point (6 ms/all points)   |  |                          |                 |
| Isolation method                | Photocoupler isolation between analog I/O terminals and internal circuits.<br>No isolation between analog I/O signals.               |  |  |  |                          |                 |
| Current consumption             | CP1W-MAD42: 5 VDC: 120 mA max., 24 VDC: 120 mA max.<br>CP1W-MAD44: 5 VDC: 120 mA max., 24 VDC: 170 mA max.                           |  | 5 VDC: 83 mA max., 24 VDC: 110 mA max.   |  |                          |                 |

## ■ Temperature Sensor Units: CP1W-TS001/TS002/TS003/TS004/TS101/TS102

By mounting a Temperature Sensor Unit to the PLC, inputs can be obtained from thermocouples or platinum resistance thermometers, and temperature measurements can be converted to binary data (4-digit hexadecimal) and stored in the input area of the CPU Unit.

| Item                       | CP1W-TS001  | CP1W-TS002 | CP1W-TS101  | CP1W-TS102 |
|----------------------------|---|------------|---|------------|
|                            | Thermocouples   |            | Platinum resistance thermometer   |            |
| Temperature sensors        | Switchable between K and J, but same type must be used for all inputs.                        |            | Switchable between Pt100 and JPt100, but same type must be used for all inputs.             |            |
| Number of inputs           | 2   | 4          | 2   | 4          |
| Allocated input words      | 2   | 4          | 2   | 4          |
| Accuracy                   | (The larger of $\pm 0.5\%$ of converted value or $\pm 2^\circ\text{C}$ ) $\pm 1$ digit max. * |            | (The larger of $\pm 0.5\%$ of converted value or $\pm 1^\circ\text{C}$ ) $\pm 1$ digit max. |            |
| Conversion time            | 250 ms for 2 or 4 input points  |            |   |            |
| Converted temperature data | 16-bit binary data (4-digit hexadecimal)  |            |   |            |
| Isolation                  | Photocouplers between all temperature input signals   |            |   |            |
| Current consumption        | 5 VDC: 40 mA max., 24 VDC: 59 mA max.   |            | 5 VDC: 54 mA max., 24 VDC: 73 mA max.   |            |

\* Accuracy for a K-type sensor at  $-100^\circ\text{C}$  or less is  $\pm 4^\circ\text{C} \pm 1$  digit max.

The rotary switch is used to set the temperature range.

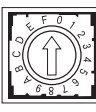
| Setting   | CP1W-TS001/TS002 |                            |                            | CP1W-TS101/TS102 |                            |                            |                   |
|---|------------------|----------------------------|----------------------------|------------------|----------------------------|----------------------------|-------------------|
|   | Input type       | Range ( $^\circ\text{C}$ ) | Range ( $^\circ\text{F}$ ) | Input type       | Range ( $^\circ\text{C}$ ) | Range ( $^\circ\text{F}$ ) |                   |
|  | 0                | K                          | -200 to 1,300              | -300 to 2,300    | Pt100                      | -200.0 to 650.0            | -300.0 to 1,200.0 |
|   | 1                |                            | 0.0 to 500.0               | 0.0 to 900.0     | JPt100                     | -200.0 to 650.0            | -300.0 to 1,200.0 |
|   | 2                | J                          | -100 to 850                | -100 to 1,500    | ---                        | Cannot be set.             |                   |
|   | 3                |                            | 0.0 to 400.0               | 0.0 to 750.0     | ---                        |                            |                   |
| 4 to F  | ---              | Cannot be set.             |                            | ---              |                            |                            |                   |



## ● Main Specifications

| Item                            |                       | CP1W-TS003   |
|---------------------------------|-----------------------|--|
| Temperature sensors             |                       | Thermocouples or analog input *1   |
|                                 |                       | Switchable between K and J, but same type must be used for all inputs.                                   |
| Number of inputs                |                       | Thermocouples inputs :4 , Analog inputs :2<br>Two analog inputs can be shared with thermocouples inputs. |
| Accuracy at 25°C                | Thermocouple inputs   | (The larger of $\pm 0.5\%$ of converted value or $\pm 2^\circ\text{C}$ ) $\pm 1$ digit max. *2           |
|                                 | Analog voltage inputs | 0.5% full scale  |
|                                 | Analog inputs         | 0.6% full scale  |
| Accuracy at 0 to 55°C           | Thermocouple inputs   | (The larger of $\pm 1\%$ of converted value or $\pm 4^\circ\text{C}$ ) $\pm 1$ digit max. *3             |
|                                 | Analog voltage inputs | 1.0 % full scale   |
|                                 | Analog inputs         | 1.2 % full scale   |
| Input signal range              | Thermocouple inputs   | K: -200.0 to 1300.0°C or .300.0 to 2300.0°F<br>J: -100.0 to 850.0°C or .100.0 to 1500.0°F                |
|                                 | Analog voltage inputs | 0 to 10V/1 to 5V   |
|                                 | Analog inputs         | 4 to 20mA  |
| Resolution                      | Thermocouple inputs   | 0.1°C or 0.1°F   |
|                                 | Analog inputs         | 1/12000 (full scale)   |
| Max. rated input                | Analog voltage inputs | $\pm 15\text{V}$   |
|                                 | Analog inputs         | $\pm 30\text{mA}$  |
| External input impedance        | Analog voltage inputs | 1M $\Omega$ min.   |
|                                 | Analog inputs         | Approx. 250 $\Omega$   |
| Open-circuit detection function |                       | Supported  |
| Averaging function              |                       | Unsupported  |
| Conversion time                 |                       | 250 ms for 4 input points  |
| Converted temperature data      |                       | 16-bit binary data (4-digit hexadecimal)   |
| Converted AD data               |                       | 16-bit binary data (4-digit hexadecimal)   |
| Isolation                       |                       | Photocouplers between all temperature and analog input signals   |
| Current consumption             |                       | 5 VDC: 70 mA max., 24 VDC: 30 mA max.  |

\*1 Only last two channels can be used as analog input.

\*2 Accuracy for a K-type sensor at -100°C or less is  $\pm 4^\circ\text{C} \pm 1$  digit max.

\*3 Accuracy for a K-type sensor at -100°C or less is  $\pm 10^\circ\text{C} \pm 1$  digit max.

## DIP Switch Settings

The DIP switch is used to set the input type (temperature or analog input), the input thermocouple type (K or J) and the temperature unit (°C or °F).

**Note:** Set the temperature range according to the type of temperature sensor connected to the Unit. Temperature data will not be converted correctly if the temperature range does not match the sensor.

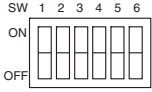
| SW  |   | Setting   |     |                   |
|---|---|---|-----|-------------------|
|  | 1 | Thermocouple type of temperature sensor             | ON  | J                 |
|   |   |   | OFF | K                 |
|   | 2 | Temperature unit                                    | ON  | °F                |
|   |   |   | OFF | °C                |
|   | 3 | NC  |     |                   |
|   | 4 | Input type selection for the third input (Input 2)  | ON  | Analog input      |
|   |   |   | OFF | Thermocouple      |
|   | 5 | Input type selection for the fourth input (Input 3) | ON  | Analog input      |
|   |   |   | OFF | Thermocouple      |
|   | 6 | Analog input signal range                           | ON  | 1 to 5V/4 to 20mA |
|   |   |   | OFF | 0 to 10V          |

| Temperature input |                  |                |
|-------------------|------------------|----------------|
| Input type        | Range (°C)       | Range (°F)     |
| K                 | -200.0 to 1300.0 | -300 to 2300   |
| J                 | -100.0 to 850.0  | -100.0 to 1500 |

# CP1H

## ● Main Specifications

| Item                       |           | CP1W-TS004   |
|----------------------------|-----------|--|
| Temperature sensors        |           | Thermocouples  |
|                            |           | Switchable between K and J, but same type must be used for all inputs.                         |
| Number of inputs           |           | 12   |
| Accuracy                   | 25°C      | (The larger of $\pm 0.5\%$ of converted value or $\pm 2^\circ\text{C}$ ) $\pm 1$ digit max. *1 |
|                            | 0 to 55°C | (The larger of $\pm 1\%$ of converted value or $\pm 4^\circ\text{C}$ ) $\pm 1$ digit max. *2   |
| Conversion time            |           | 500 ms for 12 input points   |
| Converted temperature data |           | 16-bit binary data (4-digit hexadecimal)   |
| Isolation                  |           | Photocouplers between all temperature and analog input signals                                 |
| Current consumption        |           | 5 VDC: 80 mA max., 24 VDC: 50 mA max.  |

\*1 Accuracy for a K-type sensor at  $-100^\circ\text{C}$  or less is  $\pm 4^\circ\text{C} \pm 1$  digit max.

\*2 Accuracy for a J-type sensor at  $-100^\circ\text{C}$  or less is  $\pm 10^\circ\text{C} \pm 1$  digit max.

## DIP Switch Settings

The DIP switch is used to set the temperature unit and to set the temperature input range.

**Note:** Set the temperature range according to the type of temperature sensor connected to the Unit. Temperature data will not be converted correctly if the temperature range does not match the sensor.

| SW | Setting |                  |
|----|---------|------------------|
|    | 1       | Input type       |
|    |         | ON               |
|    | 2       | Temperature unit |
|    |         | OFF              |

| Temperature input |                  |                |
|-------------------|------------------|----------------|
| Input type        | Range (°C)       | Range (°F)     |
| K                 | -200.0 to 1300.0 | -300 to 2300   |
| J                 | -100.0 to 850.0  | -100.0 to 1500 |

## ■ CP1W-SRT21 CompoBus/S I/O Link Unit

The CompoBus/S I/O Link Unit functions as a slave for a CompoBus/S Master Unit (or an SRM1 CompoBus/S Master Control Unit) to form an I/O Link with 8 inputs and 8 outputs between the CompoBus/S I/O Link Unit and the Master Unit.

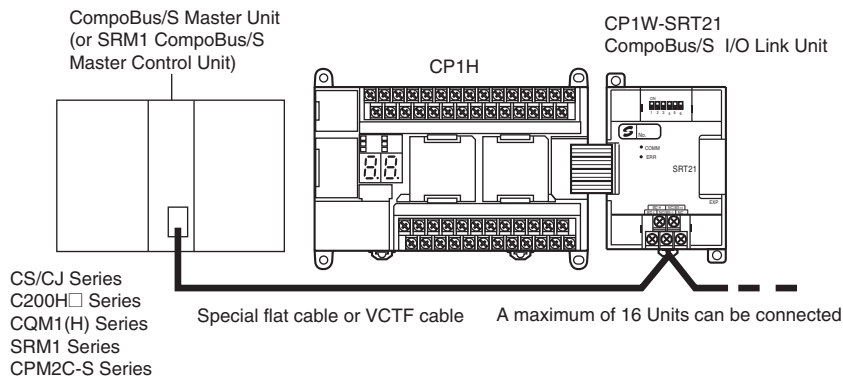

## ● Specifications

| Item  | Model | CP1W-SRT21   |
|---|-------|--|
| Master/Slave                                |       | CompoBus/S Slave   |
| Number of I/O bits                          |       | 8 input bits, 8 output bits  |
| Number of words occupied in CP1H I/O memory |       | 1 input word, 1 output word (Allocated in the same way as for other Expansion Units) |
| Node number setting                         |       | Set using the DIP switch (before the CPU Unit is turned ON.)                         |

## I/O Bits and I/O Allocations

With CP1H CPU Units, the beginning input and output words (CIO 0 and CIO 100) are allocated by the CPU Unit one or two words at a time. I/O bits are allocated in word units in order of connection to Expansion Units and Expansion I/O Units connected to a CPU Unit.

| CPU Unit                         | Allocated words |                     |
|----------------------------------|-----------------|---------------------|
|                                  | Inputs          | Outputs             |
| CP1H CPU Unit with 40 I/O points | CIO 0 and CIO 1 | CIO 100 and CIO 101 |

**Note:** For details on the number of words allocated to Expansion Units and Expansion I/O Units, refer to *Words Allocated to CP1W Expansion Units and Expansion I/O Units* on page 26.

### ● Example: I/O Bit Allocations When Expansion Units Are Connected

CPU Unit with 40 I/O Points + Temperature Sensor Unit + Analog Output Unit + Expansion I/O Unit with 40 I/O Points

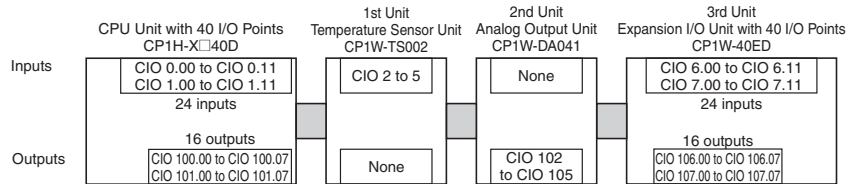

# CP1H

## Expansion Unit and Expansion I/O Units Specifications

### ■ Maximum Number of CP1W Expansion Unit and Expansion I/O Units ● CP1H CPU Unit

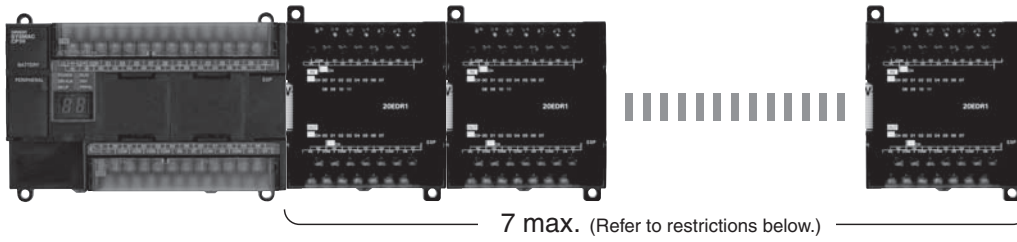

### ■ Restrictions on the Number of CP1H Expansion Unit and I/O Unit Connections

Up to seven Expansion Units and Expansion I/O Units can be connected when a CP1H CPU Unit is used, but the following restrictions apply. Observe these restrictions when using the models in the shaded areas in the following tables. A maximum total of 15 input words is allocated for Expansion Units and a maximum total of 15 output words is allocated for Expansion Units and Expansion I/O Units.

### ● Words Allocated to CP1W Expansion Units and Expansion I/O Units

| Unit type                | Model                                       | No. of words |        |     |
|--------------------------|---|--------------|--------|-----|
|                          |   | Input        | Output |     |
| Expansion I/O Units      | 40 I/O points                               | CP1W-40EDR   | 2      | 2   |
|                          |   | CP1W-40EDT   |        |     |
|                          |   | CP1W-40EDT1  |        |     |
|                          | 32 outputs                                  | CP1W-32ER    | ---    | 4   |
|                          |   | CP1W-32ET    |        |     |
|                          |   | CP1W-32ET1   |        |     |
|                          | 20 I/O points                               | CP1W-20EDR1  | 1      | 1   |
|                          |   | CP1W-20EDT   |        |     |
|                          |   | CP1W-20EDT1  |        |     |
|                          | 16 outputs                                  | CP1W-16ER    | ---    | 2   |
|                          |   | CP1W-16ET    |        |     |
|                          |   | CP1W-16ET1   |        |     |
|                          | 8 inputs                                    | CP1W-8ED     | 1      | --- |
|                          |   | CP1W-8ER     |        |     |
|                          |   | CP1W-8ET     |        |     |
| 8 outputs                | CP1W-8ET1                                   | ---          | 1      |     |
|                          | CP1W-8ED                                    |              |        |     |
|                          | CP1W-8ER                                    |              |        |     |
| Analog Input Unit        | A/D: 4 points                               | CP1W-AD041   | 4      | 2   |
|                          |   | CP1W-AD042   |        |     |
| Analog Output Unit       | DA: 2 points                                | CP1W-DA021   | ---    | 2   |
|                          | DA: 4 points                                | CP1W-DA041   | ---    | 4   |
| Analog I/O Unit          | A/D: 2 points<br>D/A: 1 point               | CP1W-MAD11   | 2      | 1   |
|                          | A/D: 4 points<br>D/A: 2 points              | CP1W-MAD42   | 4      | 2   |
|                          | A/D: 4 points<br>D/A: 4 points              | CP1W-MAD44   | 4      | 4   |
| Temperature Sensor Unit  | Thermocouple (J or K)                       | CP1W-TS001   | 2      | --- |
|                          |   | CP1W-TS002   | 4      | --- |
|                          | Thermocouple (J or K)                       | CP1W-TS003   | 4      | --- |
|                          | Thermocouple (J or K)<br>A/D: 2 points      | CP1W-TS004   | 2      | 1   |
|                          | Platinum resistance thermometer (Pt or JPt) | CP1W-TS101   | 2      | --- |
| CP1W-TS102               |   | 4            |        |     |
| CompoBus/S I/O Link Unit | 8 inputs and 8 outputs                      | CP1W-SRT21   | 1      | 1   |

For example, the CP1W-TS002 Temperature Sensor Unit is allocated four words per Unit, so no more than three Units can be connected (4 words x 3 Units = 12 words). It would then be possible to mount a combination of other Units to use the remaining three input and 15 output words.

### Examples of Possible Combinations

| Number of Units | Input                        | Output                      |
|-----------------|------------------------------|-----------------------------|
| CP1H-X40DR-A    |                              |                             |
| CP1W-TS002 x 3  | 4 words x 3 Units = 12 words | 0 words                     |
| CP1W-TS001 x 1  | 2 words x 1 Unit = 2 words   | 0 words                     |
| CP1W-20EDR1 x 1 | 1 word x 1 Unit = 1 word     | 1 word x 1 Unit = 1 word    |
| CP1W-DA041 x 2  | 0 words                      | 4 words x 2 Units = 8 words |
| Total: 7 Units  | Total: 15 words              | Total: 9 words              |
| ≤7 Units        | ≤15 words                    | ≤15 words                   |

**Using CP1W-CN811 I/O Connecting Cable**

- I/O Connecting Cable can be connected to any Unit from the CP1H CPU Unit to the third Expansion Unit or Expansion I/O Unit (i.e., the fourth Unit).
- Only one I/O Connecting Cable can be used in each CP1H PLC.
- Even when I/O Connecting Cable is used, the above restrictions on the number of connectable CP1W Expansion Units and Expansion I/O Units still apply.

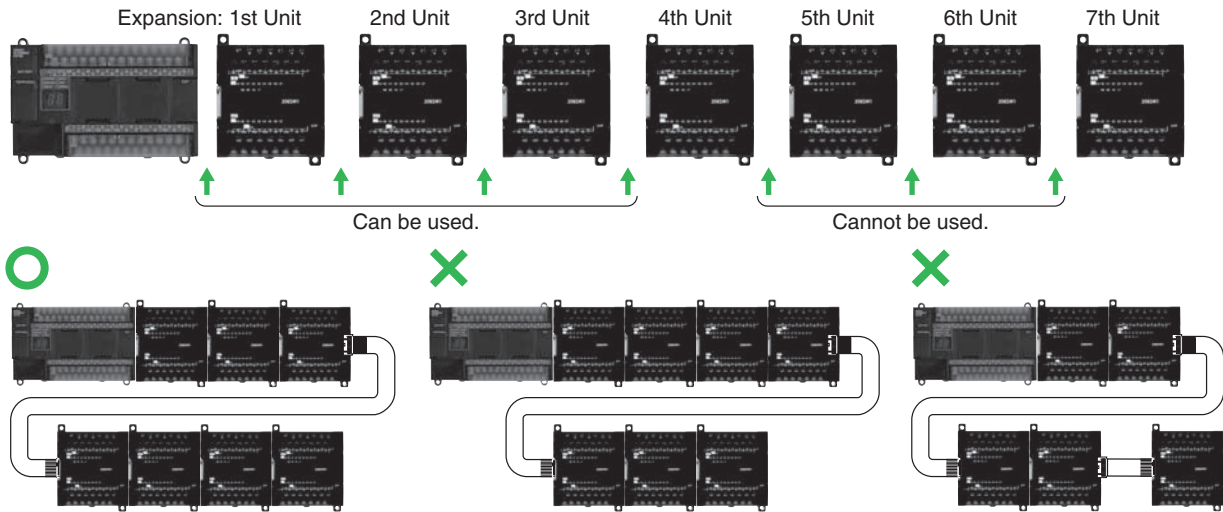

**Using CJ-series Special I/O Units or CPU Bus Units with a CP1H CPU Unit**

Up to two CJ-series Special I/O Units or CPU Bus Units can be connected by using a CP1W-EXT01 CJ Unit Adapter. The number of Units that can be used is as described below.

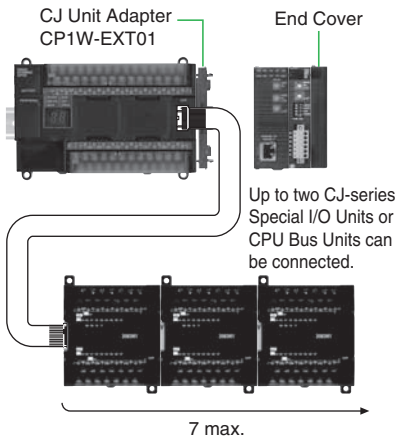

Use CP1W-CN811 I/O Connecting Cable when using CP1W Expansion Units and Expansion I/O Units at the same time as a CJ Unit Adapter. In this situation, the number of CP1W Expansion Unit and Expansion I/O Units that can be connected is subject to the restrictions described above. Only one I/O Connecting Cable can be used.

**CJ-series Special I/O Units and CPU Bus Units** (For details, refer to the CJ1 Catalog (Cat. No. P052)).

| Unit name           | Model                               | 5 V Current consumption (A) | Unit name                             | Model                   | 5 V Current consumption (A) |                        |
|---------------------|-------------------------------------|-----------------------------|---------------------------------------|-------------------------|-----------------------------|------------------------|
| Analog Input Units  | CJ1W-AD042                          | 0.52 A                      | Position Control Units                | CJ1W-NC113              | 0.25 A                      |                        |
|                     | CJ1W-AD081-V1                       | 0.42 A                      |                                       | CJ1W-NC213              |                             |                        |
|                     | CJ1W-AD041-V1                       |                             |                                       | CJ1W-NC413              | 0.36 A                      |                        |
| Analog Output Units | CJ1W-DA042V                         | 0.40 A                      |                                       | CJ1W-NC133              | 0.25 A                      |                        |
|                     | CJ1W-DA08V                          | 0.14 A                      |                                       | CJ1W-NC233              |                             |                        |
|                     | CJ1W-DA08C                          |                             | 0.12 A                                | CJ1W-NC433              | 0.36 A                      |                        |
|                     | CJ1W-DA041                          | 0.12 A                      |                                       | High-speed Counter Unit | CJ1W-CT021                  | 0.25 A                 |
|                     | CJ1W-DA021                          |                             |                                       | ID Sensor Units         | CJ1W-V680C11                | 0.26 A (24 VDC 0.13 A) |
| Analog I/O Unit     | CJ1W-MAD42                          | 0.58 A                      | CJ1W-V680C12                          |                         |                             | 0.32 A (24 VDC 0.26 A) |
|                     | CJ1W-PH41U                          | 0.30 A                      |                                       |                         | CJ1W-V600C11                | 0.26 A (24 VDC 0.12 A) |
| Process Input Units | CJ1W-AD04U                          | 0.32 A                      | CJ1W-V600C12                          |                         |                             | 0.32 A (24 VDC 0.24 A) |
|                     | CJ1W-PTS51                          | 0.25 A                      |                                       |                         | Serial Communications Units | CJ1W-SCU42             |
|                     | CJ1W-PTS52                          |                             | 0.18 A                                |                         |                             | CJ1W-SCU22             |
|                     | CJ1W-PTS15                          | 0.25 A                      |                                       | CJ1W-SCU32              |                             | 0.46 A                 |
|                     | CJ1W-PDC15                          |                             | Temperature Control Units             | CJ1W-SCU41-V1           | 0.38 A*                     |                        |
| CJ1W-TC001          | 0.25 A                              |                             |                                       | CJ1W-SCU21-V1           | 0.28 A*                     |                        |
| CJ1W-TC002          |                                     | CJ1W-SCU31-V1               |                                       | 0.38 A                  |                             |                        |
| CJ1W-TC003          |                                     | Ethernet Unit               |                                       | CJ1W-ETN21              | 0.37 A                      |                        |
| CJ1W-TC004          |                                     |                             |                                       | CompoBus/S Master Unit  | CJ1W-SRM21                  | 0.15 A                 |
| CJ1W-TC101          |                                     |                             |                                       |                         | CompoNet™ Master Unit       | CJ1W-CRM21             |
| CJ1W-TC102          |                                     |                             | MECHATROLINK-II Position Control Unit |                         |                             | CJ1W-NC271             |
| CJ1W-TC103          | CJ1W-NC471                          |                             |                                       |                         |                             |                        |
| CJ1W-TC104          | CJ1W-NCF71                          |                             |                                       |                         |                             |                        |
|                     | CJ1W-NCF71-MA                       |                             |                                       |                         |                             |                        |
|                     | MECHATROLINK-II Motion Control Unit | CJ1W-MCH71                  | 0.6 A                                 |                         |                             |                        |
|                     | FL-net Unit                         | CJ1W-FLN22                  | 0.37 A                                |                         |                             |                        |
|                     | High-speed Data Storage Unit        | CJ1W-SPU01-V2               | 0.56 A                                |                         |                             |                        |

\* The current consumption increases by 0.15 A/Adapter when NT-AL001 Link Adapters are used.

# CP1H

## Current Consumption

- Based on the current consumption when CJ-series Special I/O Units or CPU Bus Units are used with a CP1H CPU Unit, the maximum number of Units that can be used is two CJ-series Units and seven CP1W Expansion Units and Expansion I/O Units.

The current consumption for the CP1H must be no more than 2 A for 5 V and 1 A for 24 V, and the total current consumption must be no more than 30 W.

Check the total current consumption to be sure these limits are not exceeded referring to page 28 for the CP1H CPU Unit and CP1W Expansion Unit and Expansion I/O Unit current consumptions and to the above table for CJ-series Unit current consumptions.

### ● CPU Units

| Model          | Current consumption |        | External power supply   |
|----------------|---------------------|--------|-------------------------|
|                | 5 VDC               | 24 VDC | 24 VDC (See note 5.)    |
| CP1H-X40DR-A   | 0.42 A              | 0.07 A | 0.3 A max. (0.9 A max.) |
| CP1H-X40DT-D   | 0.50 A              | 0.01 A | ---                     |
| CP1H-X40DT1-D  | 0.50 A              | 0.02 A | ---                     |
| CP1H-XA40DR-A  | 0.43 A              | 0.18 A | 0.3 A max. (0.8 A max.) |
| CP1H-XA40DT-D  | 0.51 A              | 0.12 A | ---                     |
| CP1H-XA40DT1-D | 0.51 A              | 0.15 A | ---                     |
| CP1H-Y20DT-D   | 0.55 A              | ---    | ---                     |

- Note:**
1. The current consumption of the CP1W-ME05M Memory Cassette and the CP1W-CIF01/CIF11 Option Boards are included in the current consumption of the CPU Unit.
  2. CPU Units with DC power do not provide an external power supply.
  3. The current consumptions given in the following table must be added to the current consumption of the CPU Unit if an Expansion Unit or Expansion I/O Unit is connected.
  4. The external power supply cannot be used if an Expansion Unit or Expansion I/O Unit is connected to a CPU Unit with 14 or 20 I/O points.
  5. Values in parentheses are the maximum external power supply for a CPU Unit to which an Expansion I/O Unit is not connected. Refer to the *CP1H CPU Unit Operation Manual* (Cat. No. W450) for details.

### ● Option Units

| Unit name                                | Model      | Current consumption |        |
|--|------------|---------------------|--------|
|  |            | DC5V                | 24 VDC |
| RS-232C Option Board                     | CP1W-CIF01 | --- *               | ---    |
| RS-422A/485 Option Board                 | CP1W-CIF11 | --- *               | ---    |
| RS-422A/485 (Isolated-type) Option Board | CP1W-CIF21 | 0.075A              | ---    |
| Ethernet Option Board                    | CP1W-CIF41 | 0.130A              | ---    |
| LCD Option Board                         | CP1W-DAM01 | 0.020A              | ---    |
| Memory Cassette                          | CP1W-ME05M | --- *               | ---    |
| CJ Unit Adapter                          | CP1W-EXT01 | --- *               | ---    |

- \* The current consumption of the following is included with the current consumption of the CPU Unit:  
CP1W-ME05M Memory Cassette, CP1W-CIF-01 or CP1W-CIF11 Option Board, and CP1W-EXT01 CJ Unit Adapter.

### ● Others : Equipment that uses internal power supply of PLC

| Unit name                        | Model                           | Current consumption |        |
|----------------------------------|---------------------------------|---------------------|--------|
|                                  |                                 | 5 VDC               | 24 VDC |
| Link Adapter                     | CJ1W-CIF11                      | 0.04A               | ---    |
|                                  | NT-AL001                        | 0.15A               | ---    |
| Programmable Terminal<br>NV3W-V1 | Backlight<br>(Green/Orange/Red) | 0.2A                | ---    |
|                                  | Backlight<br>(White/Pink/Red)   | 0.2A                | ---    |

### ● Expansion Units and Expansion I/O Units

| Unit name                |  | Model       | Current consumption |         |
|--------------------------|--|-------------|---------------------|---------|
|                          |  |             | 5 VDC               | 24 VDC  |
| Expansion I/O Units      | 40 I/O points<br>24 inputs<br>16 outputs       | CP1W-40EDR  | 0.080 A             | 0.090 A |
|                          |  | CP1W-40EDT  | 0.160 A             | ---     |
|                          |  | CP1W-40EDT1 |                     |         |
|                          | 32 outputs                                     | CP1W-32ER   | 0.049 A             | 0.131 A |
|                          |  | CP1W-32ET   | 0.113 A             | ---     |
|                          |  | CP1W-32ET1  |                     |         |
|                          | 20 I/O points<br>12 inputs<br>8 outputs        | CP1W-20EDR1 | 0.103 A             | 0.044 A |
|                          |  | CP1W-20EDT  | 0.130 A             | ---     |
|                          |  | CP1W-20EDT1 |                     |         |
|                          | 16 outputs                                     | CP1W-16ER   | 0.042 A             | 0.090 A |
|                          |  | CP1W-16ET   | 0.076 A             | ---     |
|                          |  | CP1W-16ET1  |                     |         |
|                          | 8 inputs                                       | CP1W-8ED    | 0.018 A             | ---     |
|                          | 8 outputs                                      | CP1W-8ER    | 0.026 A             | 0.044 A |
| CP1W-8ET                 |  | 0.075 A     | ---                 |         |
| CP1W-8ET1                |  |             |                     |         |
| Analog Input Unit        | A/D: 4 points                                  | CP1W-AD041  | 0.100 A             | 0.090 A |
|                          |  | CP1W-AD042  | 0.100 A             | 0.050 A |
| Analog Output Unit       | DA: 2 points                                   | CP1W-DA021  | 0.040 A             | 0.095 A |
|                          | DA: 4 points                                   | CP1W-DA041  | 0.080 A             | 0.124 A |
|                          |  | CP1W-DA042  | 0.070 A             | 0.160 A |
| Analog I/O Unit          | A/D: 2 points<br>D/A: 1 point                  | CP1W-MAD11  | 0.083 A             | 0.110 A |
|                          | A/D: 4 points<br>D/A: 2 points                 | CP1W-MAD42  | 0.120 A             | 0.120 A |
|                          | A/D: 4 points<br>D/A: 4 points                 | CP1W-MAD44  | 0.120 A             | 0.170 A |
| Temperature Sensor Unit  | Thermocouple (J or K)                          | CP1W-TS001  | 0.040 A             | 0.059 A |
|                          |  | CP1W-TS002  |                     |         |
|                          | Thermocouple (J or K)                          | CP1W-TS003  | 0.070 A             | 0.030 A |
|                          | Thermocouple (J or K)                          | CP1W-TS004  | 0.080 A             | 0.050 A |
|                          | Platinum resistance<br>thermometer (Pt or JPt) | CP1W-TS101  | 0.054 A             | 0.073 A |
| CP1W-TS102               |  |             |                     |         |
| CompoBus/S I/O Link Unit | 8 inputs and 8 outputs                         | CP1W-SRT21  | 0.029 A             | ---     |



# CP1H

## Dimensions

(Unit: mm)

### ■ CPU Units

#### CP1H CPU Units (X/XA/Y Types)

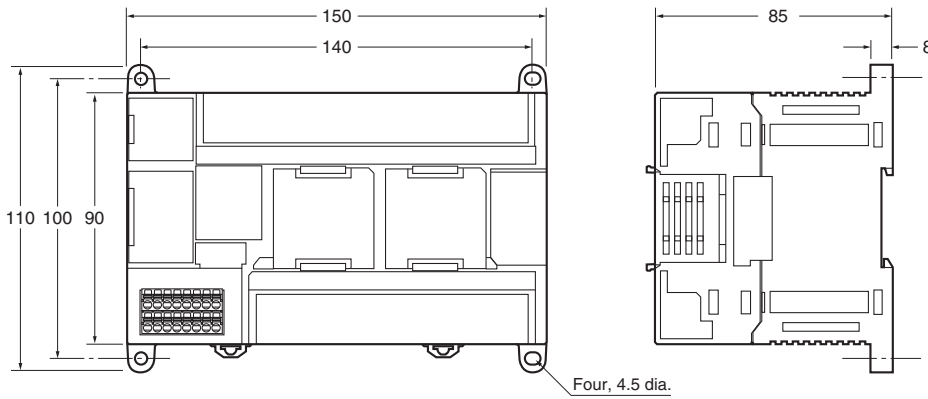

Weight:  
 CP1H-□□□-A (AC power supply):  
 740 g max.  
 CP1H-□□□-D DC power supply):  
 590 g max.

### ■ Expansion Units and Expansion I/O Units

CP1W-20ED□□, CP1W-16E□□,  
 CP1W-AD04□, CP1W-DA021/04□,  
 CP1W-MAD□□, CP1W-TS□□1/□□2/□□3

CP1W-8E□□  
 CP1W-SRT21

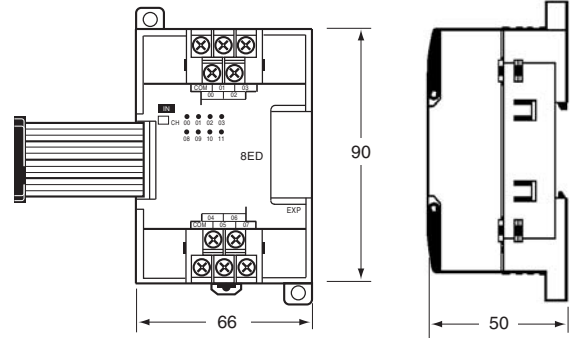
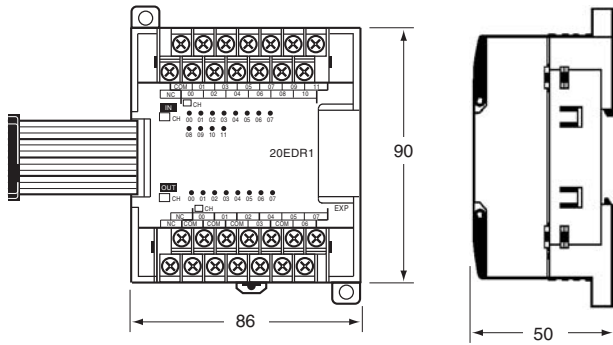

CP1W-40ED□  
 CP1W-32E□□  
 CP1W-TS004

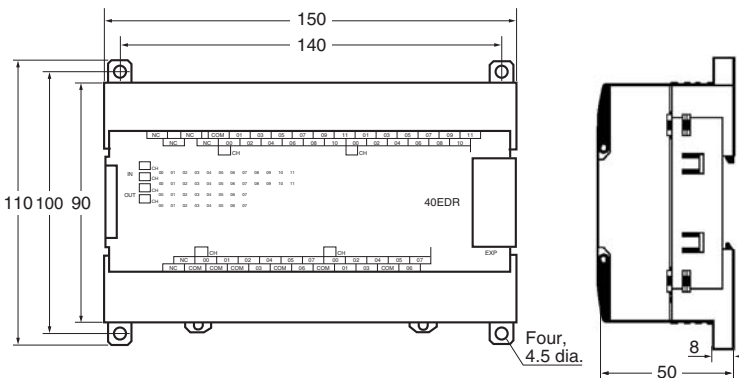

| Unit name                | Model number                    | Weight                   |
|--------------------------|---------------------------------|--------------------------|
| Expansion I/O Units      | CP1W-40EDR                      | 380 g                    |
|                          | CP1W-40EDT/-40EDT1              | 320 g                    |
|                          | CP1W-32ER                       | 465 g                    |
|                          | CP1W-32ET/-32ET1                | 325 g                    |
|                          | CP1W-20EDR1/-20EDT/-20EDT1      | 300 g                    |
|                          | CP1W-16ER                       | 280 g                    |
|                          | CP1W-16ET/-16ET1                | 225 g                    |
|                          | CP1W-8ED                        | 200 g                    |
|                          | CP1W-8ER/-8ET/-8ET1             | 250 g                    |
|                          | Analog Units                    | CP1W-AD041/-DA041/-DA021 |
| CP1W-AD042/-DA042        |                                 | 250 g                    |
| CP1W-MAD11               |                                 | 150 g                    |
| CP1W-MAD44/-MAD42        |                                 | 250 g                    |
| Temperature Sensor Units | CP1W-TS001/-TS002/-TS101/-TS102 | 250 g                    |
|                          | CP1W-TS003                      | 240 g                    |
|                          | CP1W-TS004                      | 570 g                    |
| CompoBus/S I/O Link Unit | CP1W-SRT21                      | 200 g                    |

■ CJ-series Special I/O Units and CPU Bus Units

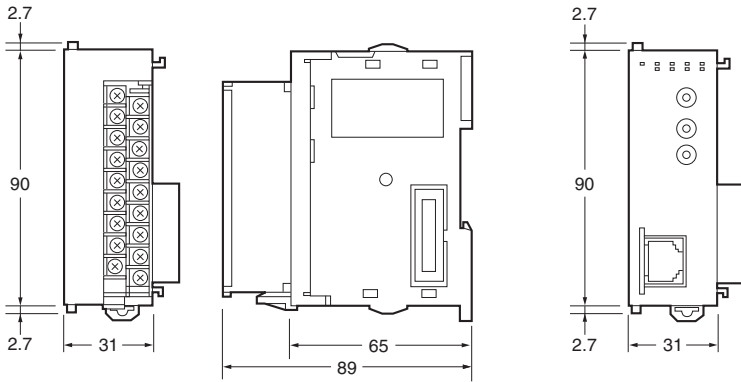

Note: It takes an example about the size.

■ CJ Unit Adaptor CP1W-EXT01

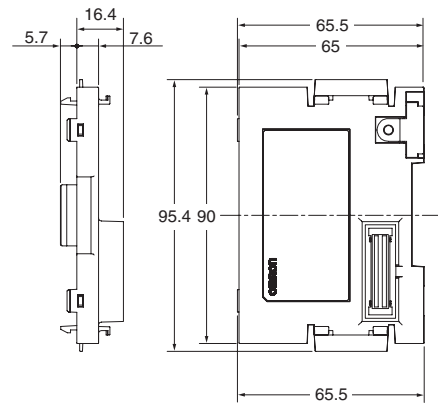

■ CP1H

Example: Two CJ-series Units (31-mm widths) Connected Using a CJ Unit Adaptor

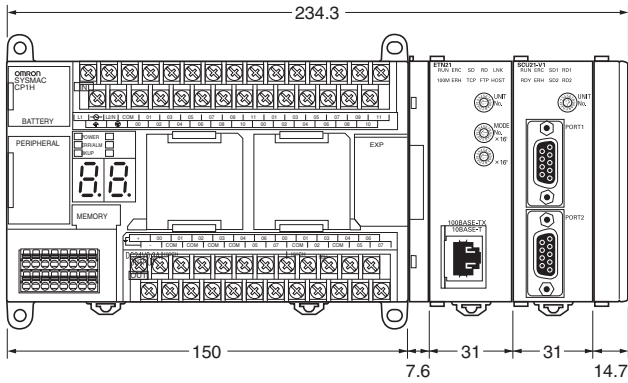

# CP1H

## Related Manuals

| Cat. No. | Model numbers  | Manual name   | Description  |
|----------|--|---|--|
| W450     | CP1H-X40D□-□<br>CP1H-XA40D□-□<br>CP1H-Y20DT-D  | CP Series<br>CP1H CPU Unit<br>Operation Manual                | Provides the following information on the CP Series: <ul style="list-style-type: none"> <li>• Overview, design, installation, maintenance, and other basic specifications</li> <li>• Features</li> <li>• System configuration</li> <li>• Mounting and wiring</li> <li>• I/O memory allocation</li> <li>• Troubleshooting</li> </ul> Use this manual together with the <i>CP1H Programmable Controllers Programming Manual (W451)</i> .                                 |
| W451     | CP1H-X40D□-□<br>CP1H-XA40D□-□<br>CP1H-Y20DT-D  | CP Series<br>CP1H CPU Unit<br>Programming Manual              | Provides the following information on the CP Series: <ul style="list-style-type: none"> <li>• Programming instructions</li> <li>• Programming methods</li> <li>• Tasks</li> <li>• File memory</li> <li>• Functions</li> </ul> Use this manual together with the <i>CP1H Programmable Controllers Operation Manual (W450)</i> .   |
| W342     | CS1G/H-CPU□□H<br>CS1G/H-CPU□□-V1<br>CS1D-CPU□□H<br>CS1D-CPU□□S<br>CS1W-SCU21<br>CS1W-SCB21-V1/41-V1<br>CJ1G/H-CPU□□H<br>CJ1G-CPU□□P<br>CP1H-CPU□□<br>CJ1G-CPU□□<br>CJ1W-SCU21-V1/41-V1 | CS/CJseries<br>Communications<br>Commands Reference<br>Manual | Describes commands addressed to CS-series and CJ-series CPU Units, including C-mode commands and FINS commands.<br><br><b>Note:</b> This manual describes on commands address to CPU Units regardless of the communications path. (CPU Unit serial ports, Serial Communications Unit/Board ports, and Communications Unit ports can be used.)<br>Refer to the relevant operation manuals for information on commands addresses to Special I/O Units and CPU Bus Units. |

# Terms and Conditions Agreement

## **Read and understand this catalog.**

Please read and understand this catalog before purchasing the products. Please consult your OMRON representative if you have any questions or comments.

## **Warranties.**

- (a) Exclusive Warranty. Omron's exclusive warranty is that the Products will be free from defects in materials and workmanship for a period of twelve months from the date of sale by Omron (or such other period expressed in writing by Omron). Omron disclaims all other warranties, express or implied.
- (b) Limitations. OMRON MAKES NO WARRANTY OR REPRESENTATION, EXPRESS OR IMPLIED, ABOUT NON-INFRINGEMENT, MERCHANTABILITY OR FITNESS FOR A PARTICULAR PURPOSE OF THE PRODUCTS. BUYER ACKNOWLEDGES THAT IT ALONE HAS DETERMINED THAT THE PRODUCTS WILL SUITABLY MEET THE REQUIREMENTS OF THEIR INTENDED USE.

Omron further disclaims all warranties and responsibility of any type for claims or expenses based on infringement by the Products or otherwise of any intellectual property right. (c) Buyer Remedy. Omron's sole obligation hereunder shall be, at Omron's election, to (i) replace (in the form originally shipped with Buyer responsible for labor charges for removal or replacement thereof) the non-complying Product, (ii) repair the non-complying Product, or (iii) repay or credit Buyer an amount equal to the purchase price of the non-complying Product; provided that in no event shall Omron be responsible for warranty, repair, indemnity or any other claims or expenses regarding the Products unless Omron's analysis confirms that the Products were properly handled, stored, installed and maintained and not subject to contamination, abuse, misuse or inappropriate modification. Return of any Products by Buyer must be approved in writing by Omron before shipment. Omron Companies shall not be liable for the suitability or unsuitability or the results from the use of Products in combination with any electrical or electronic components, circuits, system assemblies or any other materials or substances or environments. Any advice, recommendations or information given orally or in writing, are not to be construed as an amendment or addition to the above warranty.

See <http://www.omron.com/global/> or contact your Omron representative for published information.

## **Limitation on Liability; Etc.**

OMRON COMPANIES SHALL NOT BE LIABLE FOR SPECIAL, INDIRECT, INCIDENTAL, OR CONSEQUENTIAL DAMAGES, LOSS OF PROFITS OR PRODUCTION OR COMMERCIAL LOSS IN ANY WAY CONNECTED WITH THE PRODUCTS, WHETHER SUCH CLAIM IS BASED IN CONTRACT, WARRANTY, NEGLIGENCE OR STRICT LIABILITY.

Further, in no event shall liability of Omron Companies exceed the individual price of the Product on which liability is asserted.

## **Suitability of Use.**

Omron Companies shall not be responsible for conformity with any standards, codes or regulations which apply to the combination of the Product in the Buyer's application or use of the Product. At Buyer's request, Omron will provide applicable third party certification documents identifying ratings and limitations of use which apply to the Product. This information by itself is not sufficient for a complete determination of the suitability of the Product in combination with the end product, machine, system, or other application or use. Buyer shall be solely responsible for determining appropriateness of the particular Product with respect to Buyer's application, product or system. Buyer shall take application responsibility in all cases.

NEVER USE THE PRODUCT FOR AN APPLICATION INVOLVING SERIOUS RISK TO LIFE OR PROPERTY OR IN LARGE QUANTITIES WITHOUT ENSURING THAT THE SYSTEM AS A WHOLE HAS BEEN DESIGNED TO ADDRESS THE RISKS, AND THAT THE OMRON PRODUCT(S) IS PROPERLY RATED AND INSTALLED FOR THE INTENDED USE WITHIN THE OVERALL EQUIPMENT OR SYSTEM.

## **Programmable Products.**

Omron Companies shall not be responsible for the user's programming of a programmable Product, or any consequence thereof.

## **Performance Data.**

Data presented in Omron Company websites, catalogs and other materials is provided as a guide for the user in determining suitability and does not constitute a warranty. It may represent the result of Omron's test conditions, and the user must correlate it to actual application requirements. Actual performance is subject to the Omron's Warranty and Limitations of Liability.

## **Change in Specifications.**

Product specifications and accessories may be changed at any time based on improvements and other reasons. It is our practice to change part numbers when published ratings or features are changed, or when significant construction changes are made. However, some specifications of the Product may be changed without any notice. When in doubt, special part numbers may be assigned to fix or establish key specifications for your application. Please consult with your Omron's representative at any time to confirm actual specifications of purchased Product.

## **Errors and Omissions.**

Information presented by Omron Companies has been checked and is believed to be accurate; however, no responsibility is assumed for clerical, typographical or proofreading errors or omissions.

**Note: Do not use this document to operate the Unit.**

**OMRON Corporation Industrial Automation Company**  
Tokyo, JAPAN

**Contact: [www.ia.omron.com](http://www.ia.omron.com)**

**Regional Headquarters**

**OMRON EUROPE B.V.**

Wegalaan 67-69-2132 JD Hoofddorp  
The Netherlands  
Tel: (31)2356-81-300/Fax: (31)2356-81-388

**OMRON ELECTRONICS LLC**

One Commerce Drive Schaumburg,  
IL 60173-5302 U.S.A.  
Tel: (1) 847-843-7900/Fax: (1) 847-843-7787

**OMRON ASIA PACIFIC PTE. LTD.**

No. 438A Alexandra Road # 05-05/08 (Lobby 2),  
Alexandra Technopark,  
Singapore 119967  
Tel: (65) 6835-3011/Fax: (65) 6835-2711

**OMRON (CHINA) CO., LTD.**

Room 2211, Bank of China Tower,  
200 Yin Cheng Zhong Road,  
PuDong New Area, Shanghai, 200120, China  
Tel: (86) 21-5037-2222/Fax: (86) 21-5037-2200

**Authorized Distributor:**

© OMRON Corporation 2012-2014 All Rights Reserved.  
In the interest of product improvement,  
specifications are subject to change without notice.

CSM\_11\_1\_0615  
Cat. No. **P080-E1-02**

Printed in Japan  
1214 (0312)