

Connector - Part no. 1003

- screw terminals
- single part body
- cable gland and sealing
- strain relief and protection against kinking

Technical information

Ampere	16 A
Poles	3 p
Voltage	Isolating transformer
Earth position	12 h
Connection technology	Screw terminals
Contact	standard
Protection type	IP 44

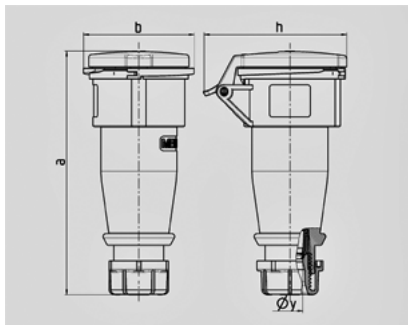

Drawing 3 MB 63	Amp. Poles	16			32		
		3	4	5	3	4	5
Dim. in mm	a	162	165	167	209	209	208
	b	60	68	76	82	82	89
	h	83	92	98	100	100	108
	y	14,5	16	16	22	22	22
Terminal for cond. cross		1	1	1	2,5	2,5	2,5
section (mm²) min.-max.		—2,5	—2,5	—2,5	—6	—6	—6