

Pro-face

OMRON Corporation
CS/CJ Series
PLC Ladder Monitor
Operation Manual

Introduction

Thank you for purchasing the PLC Ladder Monitor Add-on Kit for the OMRON Corporation CS/CJ Series. This manual explains the operation for monitoring the ladder programs of the external device and device addresses using the GP3000 Series programmable Display manufactured by Pro-face (Digital Electronics Corporation).

Please read the manual thoroughly for proper use of this product.

Be sure the manual is always available where this product is used.

Note



- (1) All programs and manuals of "PLC Ladder Monitor Add-on Kit for OMRON Corporation's CS/CJ Series" (called the product, hereafter) are copyright of Digital Electronics Corporation and Digital Electronics Corporation shall grant the users the license as described in "Software License". Any conduct violating the "Software License" is prohibited by the laws and regulations in Japan and other countries.
- (2) The manual has been prepared for additional assurance. Should you have any concerns, please contact Digital Electronics Corporation's "Support Line".
- (3) Notwithstanding the previous paragraph, Digital Electronics Corporation shall not be responsible for any damage or other loss, or any claims from a third party as a result of using this product.
- (4) Some parts and product software may differ from the description in the manual due to product improvements. For the latest descriptions, see also the separate document and on-line information.
- (5) The product may record/display some information containing intangible or intellectual property belonging to Digital Electronics Corporation. This shall not grant the users or third parties a guarantee or license for these properties of Digital Electronics Corporation. Digital Electronics Corporation shall not be held responsible for any problems arising from the recording/displaying of a third party's intellectual property using this product.

© Copyright 2008 Digital Electronics Corporation. All rights reserved.



All product names described herein are trademarks or registered trademarks of the respective owners.

Manual Description

This manual provides following cautions for proper use of the PLC Ladder Monitor Add-on Kit for the OMRON Corporation CS/CJ Series. The cautions described herein contain important safety information. The following table shows the symbols and what they mean.

| Symbol | Meaning |
|---|--|
|  | Failure to follow the instructions on the display may result in adverse events such as device errors or data loss. |
|  | Important points for use. |
| * | The footnotes contain an explanation of the annotated words. |
|  | Related reference pages are provided. |
| PLC | Programmable Logic Controller. |

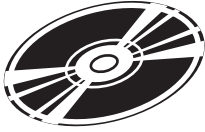
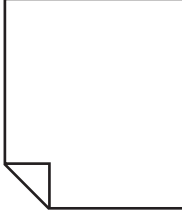
Package Content

| Package Content | | | |
|---|---|---|---|
| CD-ROM: 1 | User registry FAX sheet: 1 for Japanese/ English each | Serial barcode sticker: 1 | KEYCODE sticker: 1 |
|  |  |  |  |
| | | (Placed on the CD case) | |

Supported Models

■ Supporting External Devices

| Maker | Series Name | CPU Model | Link I/F | Connection Method*1 | Driver Name on GP-Pro EX (Version)*2 |
|-------------------|---------------|---|---|-------------------------------|--|
| OMRON Corporation | CS1 series | CS1H-CPU67 | RS232C port on the CPU unit | RS-232C or RS-422/485 (4wire) | CS/CJ series HOST link (V1.13.02 or later) |
| | | CS1H-CPU66 | | | |
| | | CS1H-CPU65 | | | |
| | | CS1H-CPU64 | Peripheral port on the CPU unit | | |
| | | CS1G-CPU45 | | | |
| | | CS1G-CPU44 | | | |
| | | CS1G-CPU43 | CS1W-SCU21 | | |
| | | CS1G-CPU42 | | | |
| | | CS1H-CPU67H | | | |
| | | CS1H-CPU66H | CS1W-SCU21-V1 | | |
| | | CS1H-CPU65H | | | |
| | | CS1H-CPU64H | | | |
| | | CS1H-CPU63H | CS1W-SCB21 | | |
| | | CS1G-CPU45H | | | |
| | | CS1G-CPU44H | | | |
| | CS1G-CPU43H | CS1W-SCB41 | | | |
| | CS1G-CPU42H | | | | |
| | CS1H-CPU67-V1 | | | | |
| | CS1H-CPU66-V1 | CS1W-ETN01 | | | |
| | CS1H-CPU65-V1 | | | | |
| | CS1H-CPU64-V1 | | | | |
| | CS1H-CPU63-V1 | | | | |
| | CS1G-CPU45-V1 | | | | |
| | CS1G-CPU44-V1 | | | | |
| | CS1G-CPU43-V1 | | | | |
| | CS1G-CPU42-V1 | | | | |
| | CS1W-ETN11 | | | | |
| | CS1W-ETN21*3 | | | | |
| | Ethernet | | CS/CJ Series Ethernet (V1.14.03 or later) | | |
| | CJ1 Series | | CJ1G-CPU45 | RS232C port on the CPU unit | RS-232C or RS-422/485 (4wire) |
| CJ1G-CPU44 | | | | | |
| CJ1M-CPU23 | | | | | |
| CJ1M-CPU22 | | | Peripheral port on the CPU unit | | |
| CJ1M-CPU21 | | | | | |
| CJ1M-CPU13 | | | | | |
| CJ1M-CPU12 | | CJ1W-SCU41 | | | |
| CJ1M-CPU11 | | | | | |
| CJ1H-CPU67H | | | | | |
| CJ1H-CPU66H | | CJ1W-SCU21 | | | |
| CJ1H-CPU65H | | | | | |
| CJ1H-CPU67H-R | | | | | |
| CJ1H-CPU66H-R | | CJ1W-SCU41-V1 | | | |
| CJ1H-CPU65H-R | | | | | |
| CJ1H-CPU64H-R | | | | | |
| CJ1G-CPU45H | CJ1W-SCU31-V1 | | | | |
| CJ1G-CPU44H | | | | | |
| CJ1G-CPU43H | | | | | |
| CJ1G-CPU42H | CJ1W-SCU21-V1 | | | | |
| CJ1W-ETN01 | | | | | |
| CJ1W-ETN11 | | | | | |
| CJ1W-ETN21*3 | Ethernet | CS/CJ Series Ethernet (V1.14.03 or later) | | | |

| Maker | Series Name | CPU Model | Link I/F | Connection Method* ¹ | Driver Name on GP-Pro EX (Version)* ² |
|--------------------------|-------------|---|--------------------------------|-------------------------------------|--|
| OMRON Corporation | CP1 Series | CP1L-M□□D□-□ CP1L-L□□D□-□ | CP1W-CIF01 | RS-232C | CS/CJ Series HOST link (V1.13.02 or later) |
| | | | CP1W-CIF11 | RS-422/485 (4wire) | |
| | | CP1H-X□□D□-□ CP1H-XA□□D□-□ CP1H-Y□□D□-□ | CP1W-CIF01 | RS-232C | |
| | | | CP1W-CIF11 | RS-422/485 (4wire) | |
| | | | CJ1W-SCU41 | RS-232C or RS-422/485 (4wire) | |
| | | | CJ1W-SCU21 | | |
| | | | CJ1W-SCU41-V1 | | |
| | | | CJ1W-SCU31-V1 CJ1W-SCU21-V1 | | |
| CJ1W-ETN21* ³ | Ethernet | CS/CJ Series Ethernet (V1.14.03 or later) | | | |

*1 Communication mode changes according to type of link unit, cables used, etc. For details, see the relevant driver manuals.

*2 The driver version can be checked by viewing [Peripheral List] in the [System Settings] window on the GP-Pro EX, or [Driver Version] on [Offline Home] on the display.

*3 Compatible with both Ethernet transfer protocols, UDP/IP and TCP/IP.

IMPORTANT

- If the driver version of a device connected to the GP-Pro EX is older than that indicated in the table, the ladder monitor will not function normally. You must upgrade the driver to at least the version indicated in the table before using the unit. For the update module, please download it from the Pro-face support site “Otasuke Pro!”.
(URL <http://www.pro-face.com/otasuke/>)

■ Relevant Display

Displays that support the ladder monitor are GP3000 Series models with VGA, SVGA, and XVGA resolution. For details on supported models, see the table below.

| | Series | Models |
|---------------|----------------|----------------|
| GP3000 series | GP-3300 series | AGP-3310HT |
| | GP-3400 series | AGP-3400S |
| | | AGP-3400S-D81 |
| | | AGP-3400S-CA1M |
| | | AGP-3400T |
| | | AGP-3400T-D81 |
| | | AGP-3400T-FN1M |
| | | AGP-3400T-CA1M |
| | | AGP-3450T |
| | GP-3500 series | AGP-3500L |
| | | AGP-3500L-D81 |
| | | AGP-3500S |
| | | AGP-3500S-D81 |
| | | AGP-3500S-CA1M |
| | | AGP-3500T |
| | | AGP-3500T-D81 |
| | | AGP-3500T-FN1M |
| | | AGP-3500T-CA1M |
| | | AGP-3510T |
| | | AGP-3510T-CA1M |
| | | AGP-3550T |
| | AGP-3560T | |
| | GP-3600 series | AGP-3600T |
| | | AGP-3600T-D81 |
| | | AGP-3600T-FN1M |
| | | AGP-3600T-CA1M |
| | AGP-3650T | |
| | GP-3700 series | AGP-3750T |

■ Screen Creation Software by Pro-face (Digital Electronics Corporation)

GP-Pro EX Ver.2.00 or later

NOTE

- Refer below for the compatible external device versions.



■ Supporting External Devices (page 3)

■ OMRON Corporation Programming Tools

CX-Programmer Series Ver.7 or earlier

NOTE

- Instructions that can be monitored using this function are those supported by the CX-Programmer Series Ver.7 or earlier programming tool by OMRON Corporation.

Table of Contents

| | |
|--------------------------|---|
| Introduction | 1 |
| Manual Description | 2 |
| Package Content | 2 |
| Supported Models | 3 |
| Table of Contents | 7 |

Chapter 1 Summary

| | |
|----------------------------------|-----|
| 1.1 Ladder Monitor | 1-2 |
| 1.2 System Configuration | 1-3 |
| 1.3 Installation Procedure | 1-6 |

Chapter 2 Using the Ladder Monitor

| | |
|--|------|
| 2.1 Settings Menu | 2-2 |
| 2.2 Monitoring the Ladder Programs of the External Device on a Display | 2-3 |
| 2.2.1 Details | 2-3 |
| 2.2.2 Setup Procedure | 2-4 |
| 2.3 Displaying Ladder Programs in Alarm History View | 2-11 |
| 2.3.1 Details | 2-11 |
| 2.3.2 Setup Procedure | 2-11 |
| 2.4 Printing the Ladder Monitor View from a Display | 2-13 |
| 2.4.1 Details | 2-13 |
| 2.4.2 Setup Procedure | 2-13 |
| 2.5 Capturing and Saving the Ladder Monitor View on a CF Card | 2-14 |
| 2.5.1 Details | 2-14 |
| 2.5.2 Setup Procedure | 2-14 |

Chapter 3 Ladder Monitor Screen Features

| | |
|---------------------------------|-----|
| 3.1 Main Screen | 3-2 |
| 3.2 File Selection Screen | 3-6 |
| 3.3 Menu Screen | 3-8 |

Chapter 4 Restrictions

1 | Summary

| | | |
|-----|------------------------------|-----|
| 1.1 | Ladder Monitor | 1-2 |
| 1.2 | System Configuration..... | 1-3 |
| 1.3 | Installation Procedure | 1-6 |

1.1 Ladder Monitor

The ladder monitor is a feature that reads and monitors the external device (OMRON Corporation PLC CS/CJ series) ladder programs on a display screen. It monitors the ladder programs online without stopping other features.

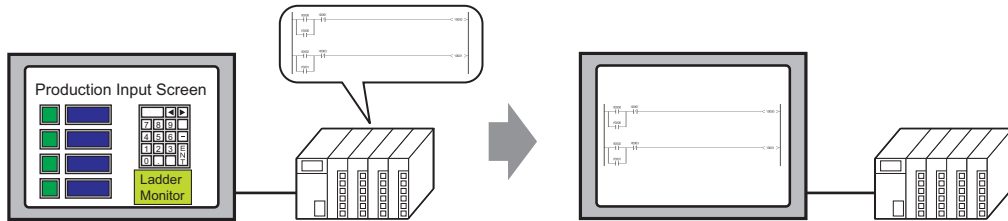

You can use the ladder monitor feature to do the following:

- Monitor the ladder program of the external device over the internet
 - Displays the contact, coil and output instruction in bold/color while they are energized
 - Display the I/O comments in the ladder program
- Specify and display the ladder program you wish to check
 - Display the ladder monitor simultaneously with the alarm display
 - Search for a step number or a device address
- Save the desired ladder program view
 - Capture and save the image on a CF Card
 - Print the desired ladder program view

NOTE

- The ladder monitor mode calls the device monitor feature.

☞ “3.3 Menu Screen” (page 3-8)

See: GP-Pro EX Reference Manual

1.2 System Configuration

NOTE

- For details regarding the connection of display devices and external devices, refer to “CS/CJ Series HOST Link Drivers” or “CS/CJ Series Ethernet Drivers” in the “GP-Pro EX Device Connection Manual.”

■ Communication Cable Connection

Display device units: Displays the connection status through the external device units.

- The display and external device are connected 1:1 with a connection cable.

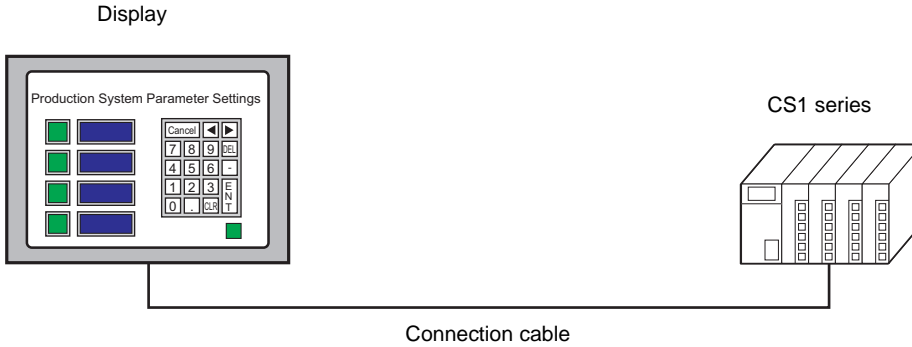

- 1-to-n connection (Only with link connection)

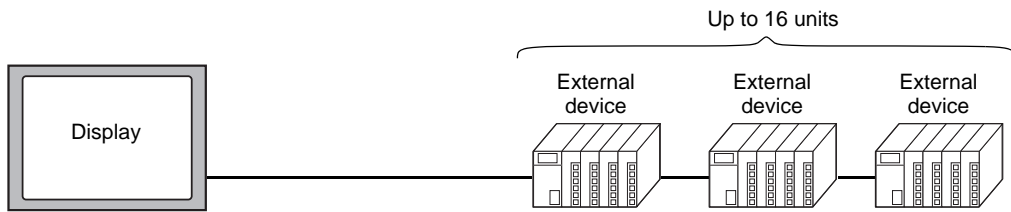

- 1-to-n connection (When accessing the link connection by surpassing the network.)

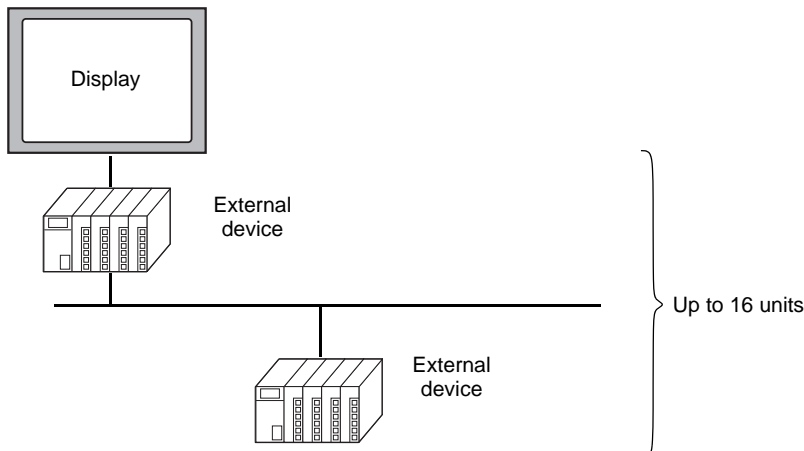

- 1-to-1 connection (Ethernet connection)

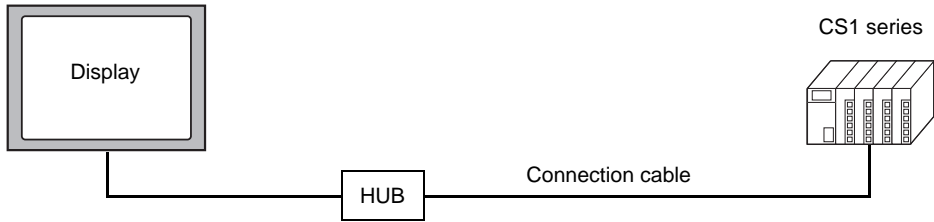

- 1-to-n connection (When accessing the Ethernet connection by surpassing the network.)

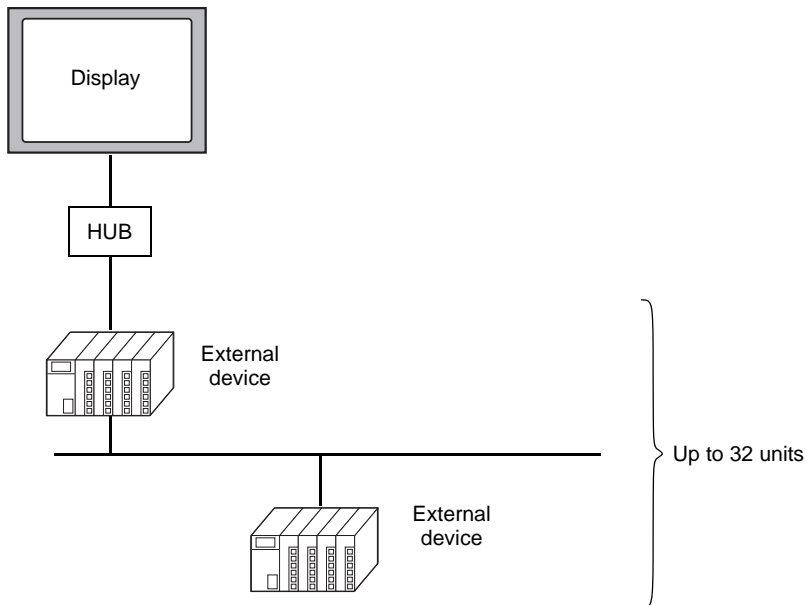

- 1-to-n connection (Ethernet connection)

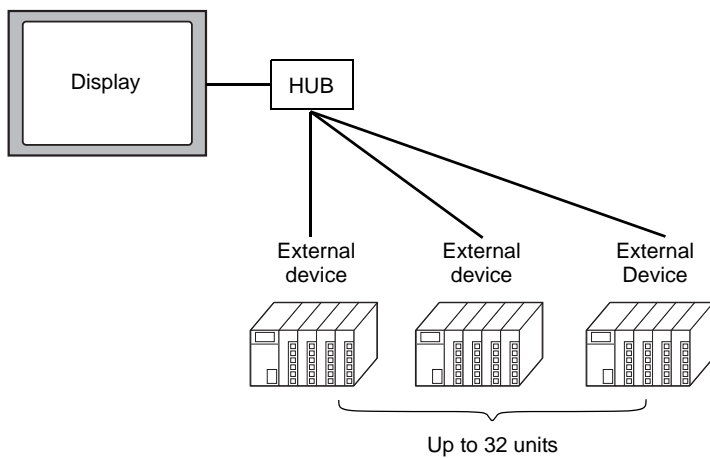

- n-to-1 connection (Ethernet connection)

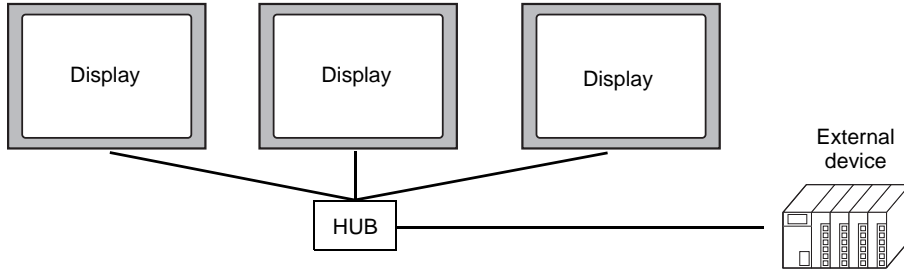

- n-to-m connection (Ethernet connection)

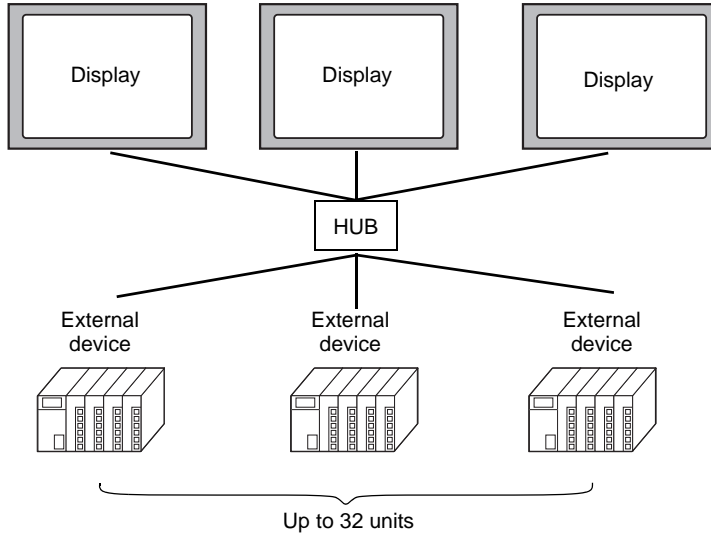

NOTE

- Through Ladder Monitor functions, the supported Ethernet transfer protocols are TCP/IP and UDP/IP.

1.3 Installation Procedure

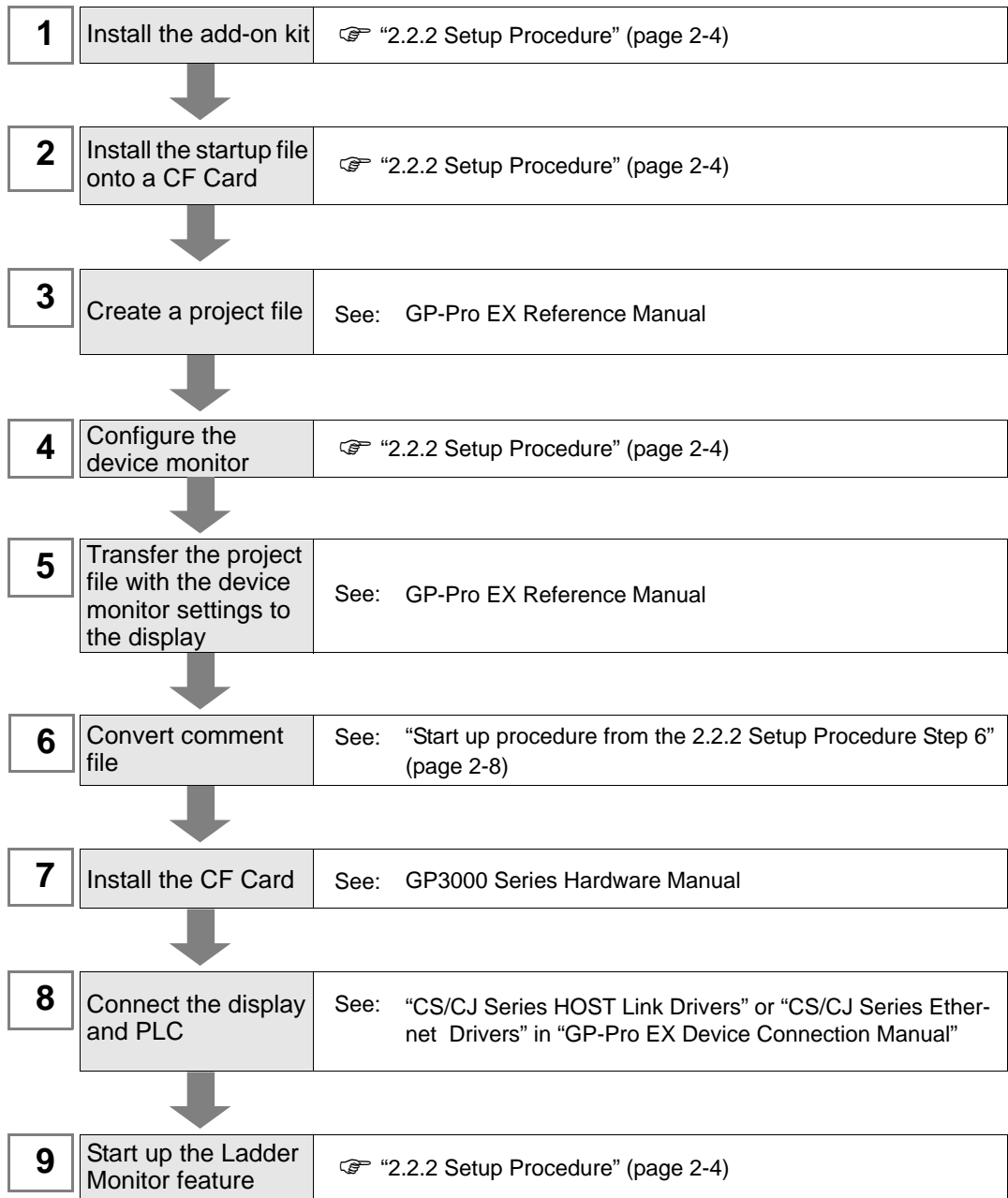

NOTE

- GP-Pro EX Manual and the Hardware Manual are available for download on the Pro-face support site “Otasuke Pro!” (<http://www.pro-face.com/otasuke/>). See the manual for GP-Pro EX Ver.2.00 or later.

2



Using the Ladder Monitor

| | | |
|-----|---|------|
| 2.1 | Settings Menu | 2-2 |
| 2.2 | Monitoring the Ladder Programs of the External Device on a Display..... | 2-3 |
| 2.3 | Displaying Ladder Programs in Alarm History View..... | 2-11 |
| 2.4 | Printing the Ladder Monitor View from a Display | 2-13 |
| 2.5 | Capturing and Saving the Ladder Monitor View on a CF Card | 2-14 |

2.1 Settings Menu

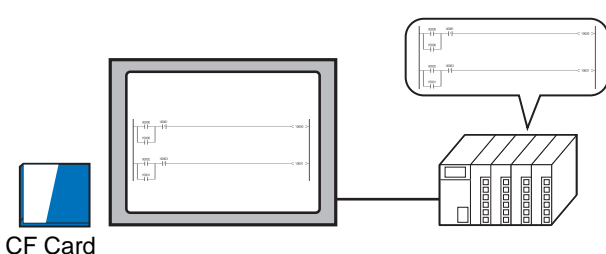
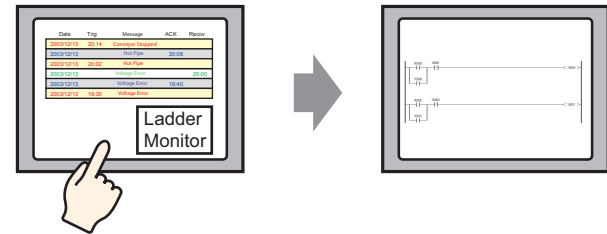
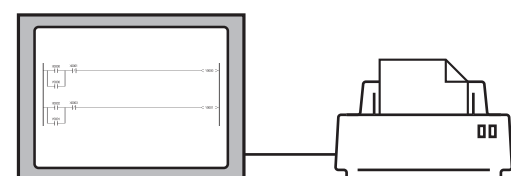
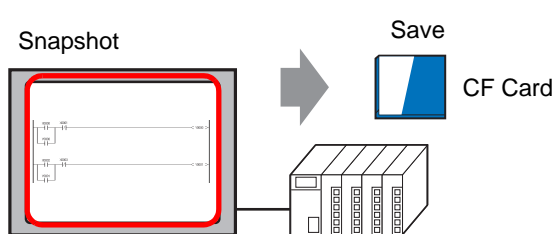
| Monitoring the Ladder Programs of the External Device on a Display | |
|---|--|
|  <p>CF Card</p> <p>You can display the ladder program of the external device on a display screen.</p> | <ul style="list-style-type: none"> ☞ “2.2.1 Details” (page 2-3) ☞ “2.2.2 Setup Procedure” (page 2-4) |
| Displaying the Relevant Ladder Programs Simultaneously from Alarm History | |
|  <p>You can display the device for which the alarm is sounding directly from the alarm history screen.</p> | <ul style="list-style-type: none"> ☞ “2.3.1 Details” (page 2-11) ☞ “2.3.2 Setup Procedure” (page 2-11) |
| Printing the Ladder Monitor Screen on a Display | |
|  <p>You can output the Ladder Monitor screen from a printer connected to the display.</p> | <ul style="list-style-type: none"> ☞ “2.4.1 Details” (page 2-13) ☞ “2.4.2 Setup Procedure” (page 2-13) |
| Capturing and Saving the Ladder Monitor Screen on a Display onto a CF Card | |
|  <p>You can capture the displayed Ladder Monitor screen and save it to a CF Card.</p> | <ul style="list-style-type: none"> ☞ “2.5.1 Details” (page 2-14) ☞ “2.5.2 Setup Procedure” (page 2-14) |

2.2 Monitoring the Ladder Programs of the External Device on a Display

2.2.1 Details

NOTE

- See the following pages for the detailed settings.
☞ Chapter3 "Ladder Monitor Screen Features" (page 3-1)
-

With the Ladder Monitor you can remotely view, search, and edit the ladder program of the external device as it appears on the HMI.

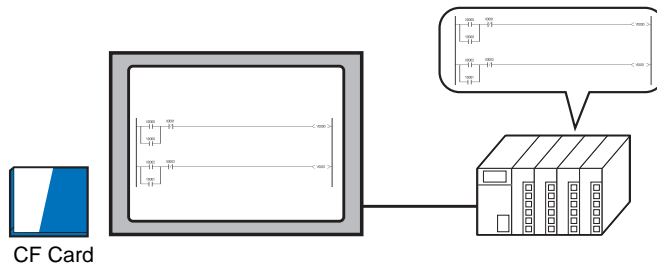

IMPORTANT

- The CF Card must have 256 MB or more of free space.
-

NOTE

- See the following pages for the search feature.
☞ "3.3 Menu Screen" (page 3-8)
-

2.2.2 Setup Procedure

- 1 Install the Ladder Monitor CD-ROM onto a PC installed with GP-Pro EX. Run Setup.exe on the CD to launch the installer. Follow the installer instructions to install.

IMPORTANT

- Your PC must have GP-Pro EX Ver.2.00 or later installed. For the OS, see the GP-Pro EX Reference Manual.
-

- 2 Install the startup file on a CF Card.

IMPORTANT

- To use this feature, the CF Card must have 256 MB or more of free space.
-

- 1) Install a CF Card onto the PC.
- 2) Start the installer by clicking on the Setup.exe file on the ladder monitor CD-ROM.
- 3) Select the setting language.
- 4) The OMRON Corporation CS/CJ Series PLC Ladder Monitor Setup Program will launch. Enter the serial no. and key code. A window appears prompting you to select an install location. Set the CF Card root directory (i.e. the top directory) as the install location.
- 5) The startup file will be installed.

- 3 Create a project file.

There are four ways to start the Ladder Monitor. To start the monitor without using the system menu, you must configure the settings for starting the Ladder Monitor in GP-Pro EX in advance.

- System menu
- Switch parts
- LS area
- System variables:
 - #H_LadderMonitor (no cache)
 - #H_LadderMonitorCache (with cache)

NOTE

- To start up using the system menu, see the following pages.
 -  Setup Procedure 9 “Start up the Ladder Monitor.” (page 2-9)
-

■ Start up procedure from switch parts

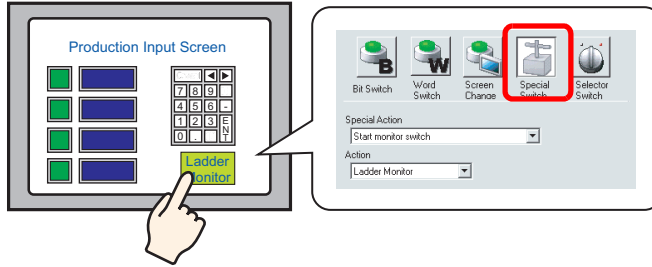

- 1) From the [Parts (P)] menu, point to [Switch Lamp (C)] and select [Special Switch (P)] or click . Click and drag to place a switch is placed on the screen.
- 2) Double-click the switch you placed and in [Special Action] select [Start monitor switch]. In [Action], select [Ladder Monitor] or [Ladder Monitor (Cache)].
 - Ladder Monitor
Reads the ladder programs from the external device every time you click the switch. The ladder program that is being forwarded is displayed on the external device but it may take time to read.
 - Ladder Monitor (Cache)
Reads the ladder programs saved on the CF Card when you click the switch, reducing the read time. To update the ladder programs on the CF Card, in [Main Screen] on the display, select [Read].

☞ “3.1 Main Screen” (page 3-2)

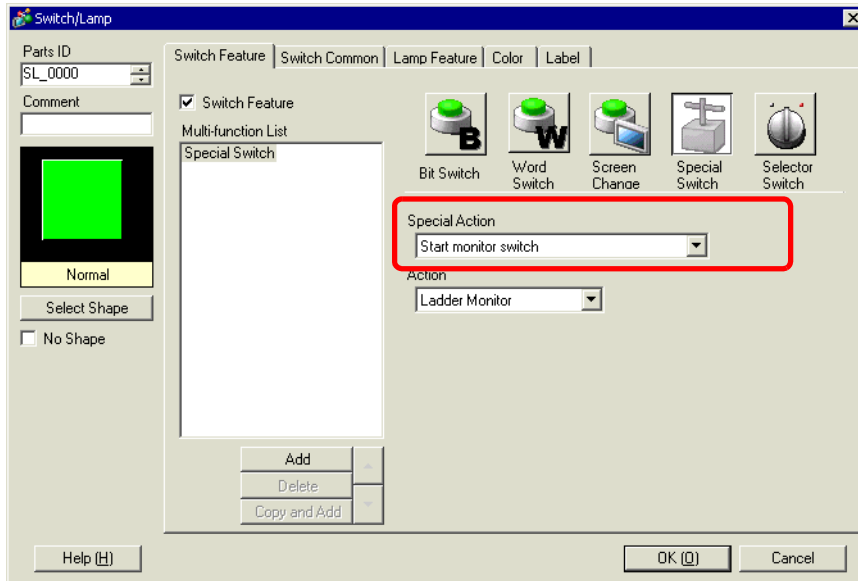

NOTE

- Read the cache from a CF Card
Normally, every time you start the Ladder Monitor, it communicates with the PLC to read the ladder programs and it may take time to display the ladder programs. To improve the display update speed, the Ladder Monitor feature reads the ladder programs of the external device onto the device CF Card (cache) first and then displays them.

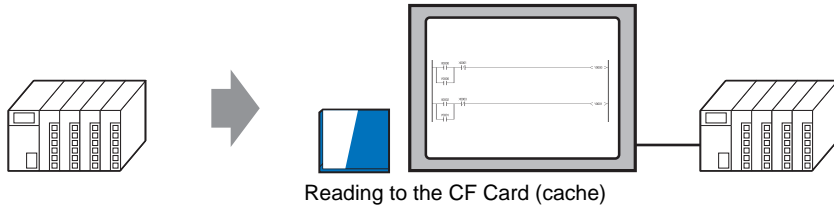

If you change the ladder programs on the external device after reading the ladder programs of the external device to the display CF Card, read the ladder programs to the CF Card again. In [Menu Bar] on the display, select [Read].

☞ “3.1 Main Screen” (page 3-2)

-
- 3) Select [Select Shape], [Color], [Label], and any other features you require and click OK.

■ **Start up procedure from the LS area**

The Ladder Monitor starts up if you turn ON bits in the LS area. Configure the settings for turning ON the following bits using switch parts and D-scripts.

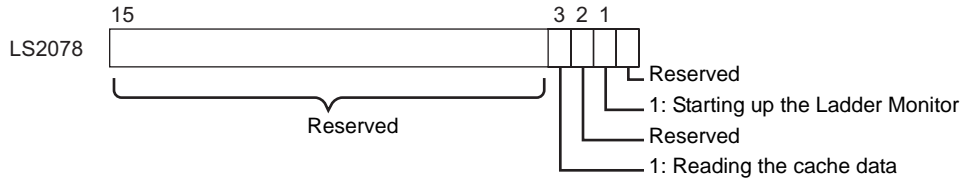

| | |
|-------|---|
| Bit 1 | Turn ON to start up the Ladder Monitor. |
| Bit 3 | <p>Turn ON to start the Ladder Monitor and display the ladder programs cached on the CF Card.</p> <p>NOTE</p> <ul style="list-style-type: none"> If the programs are not cached in advance, the bit only triggers the same action as Bit 1 turning ON (starts up the Ladder Monitor). To update the ladder programs on the CF Card, in [Main Screen] on the display, select [Read]. <p>☞ "3.1 Main Screen" (page 3-2)</p> |

IMPORTANT

- Bits other than Bits 1 and 3 are reserved. Do not use them.

NOTE

- LS area addresses will be automatically cleared when Ladder Monitor is shutdown.

4 Register the device monitor feature. In GP-Pro EX, from [System Settings], point to [Display Unit] and select [Extended Settings]. Select the [Device Monitor] checkbox.

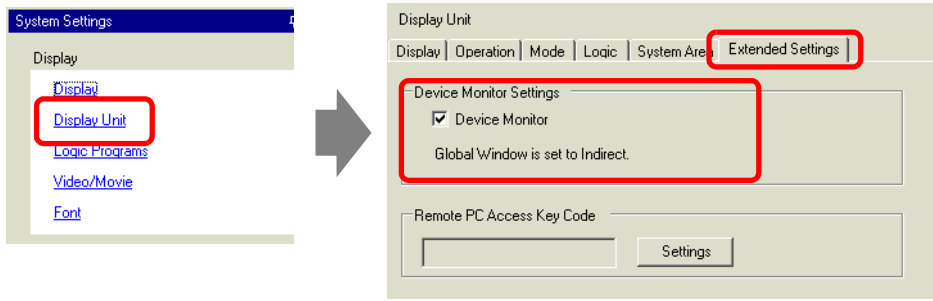

NOTE

- The device monitor screen uses a global display window. While the device monitor is displayed, the screen cannot display other global windows. When you select the [Device Monitor] checkbox, [Global Window] operation is automatically set to [Indirect].
- For manual settings, in the display system menu, point to [Offline], select [Main Unit], and select [Window Settings]. Configure the following settings in [Global Window Operation]:

Global Window Operation: Indirect
Data Type : BIN

5 Save and transfer the project file to the display.

Reference: GP-Pro EX Reference Manual

6 Using the comment file converter tool, the comment file created by CX-Programmer (***.cxt) will be converted into a file that is read by the display device (***.ocm).

- 1) Double click ComCvtEX.exe  in the CD-ROM of Ladder Monitor to start the comment converter tool.
- 2) The “GP-Pro EX CS/CJ Series Ladder Monitor Comment File Converter” dialog box will open. Configure the various articles below.

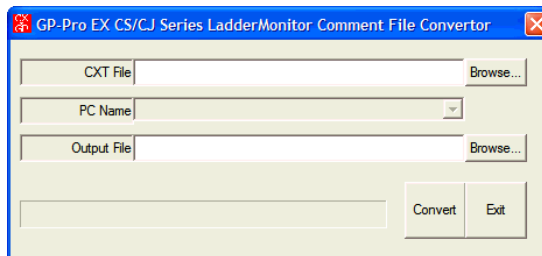

CXT File Name: Using “Browse”, select the CXT file name (***.cxt) to be converted.

PC Name: Select the desired output PC name from the CXT file as a comment file.

Output File Name: Input the file name (***.ocm) after restoration, or select it by using “Browse”.

- 3) Click “Convert”.
- 4) Save the output comment file (***.ocm) to the folder below the CF Card.
When using CS/CJ Series HOST Link Driver: PLCLDMON\OMR_FINS
When using CS/CJ Series Ethernet Driver: PLCLDMON\OMR_FINE

7 Install the CF Card onto the GP.

Reference: For details on installing a CF Card, see “GP3000 Series Hardware Manual”.

8 Connect the display to communicate with the external device.

Reference: For details on the connection, see “GP-Pro EX Device Connection Manual”

9 Start up the Ladder Monitor.

There are four ways to start up the Ladder Monitor.

- System menu
- Switch parts
- LS area
- System variables:
 #H_LadderMonitor (no cache)
 #H_LadderMonitorCache (with cache)

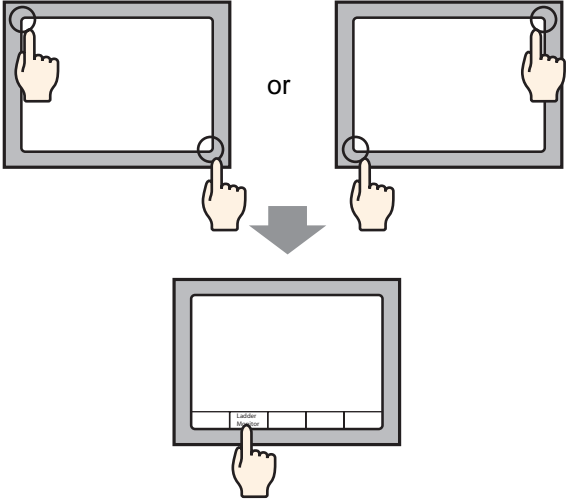
| Ladder Monitor Startup | Detail |
|---|---|
| <p>Start up with the System Menu</p> | <p>On the screen, touch the top left → on the bottom right (or the top right → on the bottom left) in this order within 0.5 Seconds to display the system menu. Touch the [Ladder Monitor] button to display the main screen.</p>  |

NOTE

- To start up using switch parts or the LS area, see the following pages.
 - ☞ Setup Procedure “■ Start up procedure from switch parts” (page 2-5)
 - ☞ Setup Procedure “■ Start up procedure from the LS area” (page 2-7)

- 10 When the ladder monitor starts up, the Device/PLC Selection screen is displayed. Select the external device for the ladder program you wish to monitor. The screen jumps to the File Selection screen.

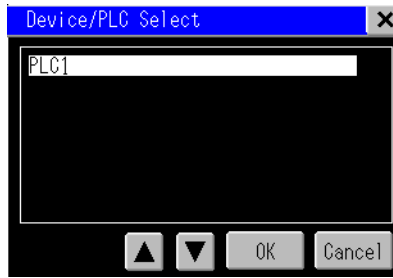

NOTE

- For the File Selection screen, see the following pages.
 ☞ “3.2 File Selection Screen” (page 3-6)
-

2.3 Displaying Ladder Programs in Alarm History View

2.3.1 Details

Place the Ladder Monitor startup switch on the alarm history screen. This allows you to display the device whose the alarm is sounding directly from the history screen.

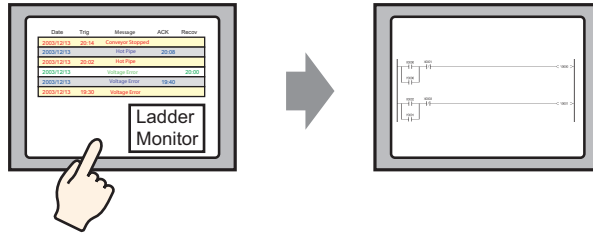

2.3.2 Setup Procedure

- 1 Place the Ladder Monitor startup switch on the alarm history screen.
☞ “2.2 Monitoring the Ladder Programs of the External Device on a Display” (page 2-3)
- 2 On the alarm history screen, touch the alarm you wish to monitor.
 Next, touch the Ladder Monitor startup switch.

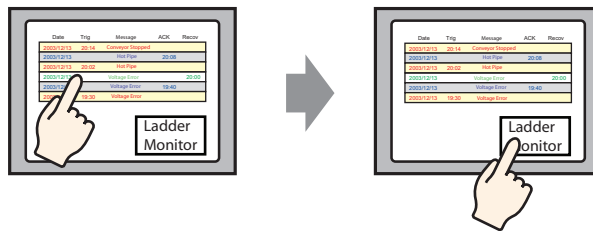

- After reading is complete, the device search keypad will be displayed
The device address you selected on the alarm history screen is automatically entered.
Touch [Search]

NOTE

- Select the appropriate external device and read it. After reading is completed the device search keypad is displayed.



- The ladder programs will be displayed starting with the device for which the alarm sounded.

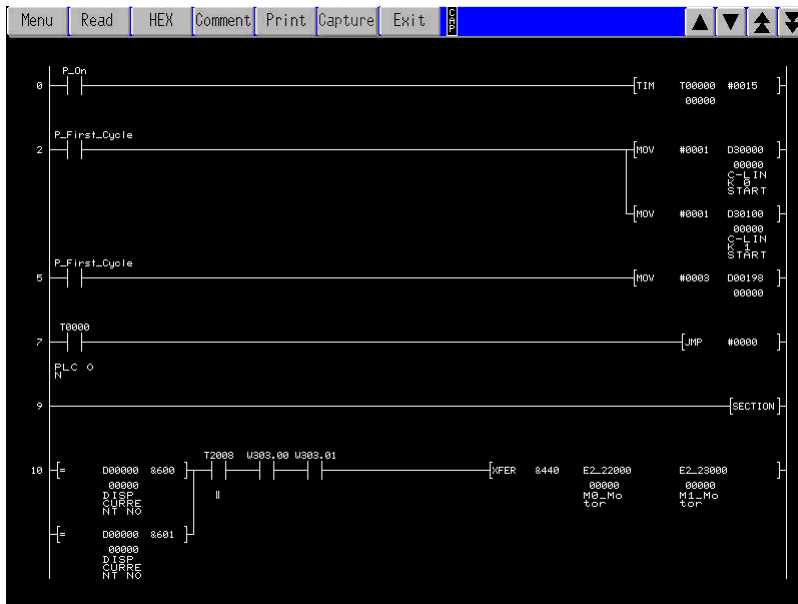

NOTE

- The previously read ladder program is displayed again. Therefore, the ladder program for which the alarm sounded may not be displayed when multiple devices are connected. If this occurs, delete the cache data (LADDER.DAT) from the CF Card and start the ladder monitor from the alarm history. Cache data is saved in the following location:
CS/CJ Series HOST Link Driver:
“PLCLDMON\OMR_FINS\LADDER.DAT”
CS/CJ Series Ethernet Driver:
“PLCLDMON\OMR_FINE\LADDER.DAT”

2.4 Printing the Ladder Monitor View from a Display

2.4.1 Details

You can output the Ladder Monitor screen from a printer connected to the display. This allows you to efficiently save and analyze data.

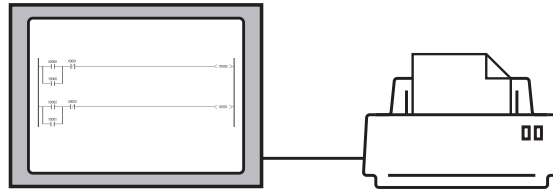

2.4.2 Setup Procedure

- 1 Connect the display to the printer.
Reference: GP-Pro EX Reference Manual

- 2 On the Ladder Monitor main screen, touch [Print].

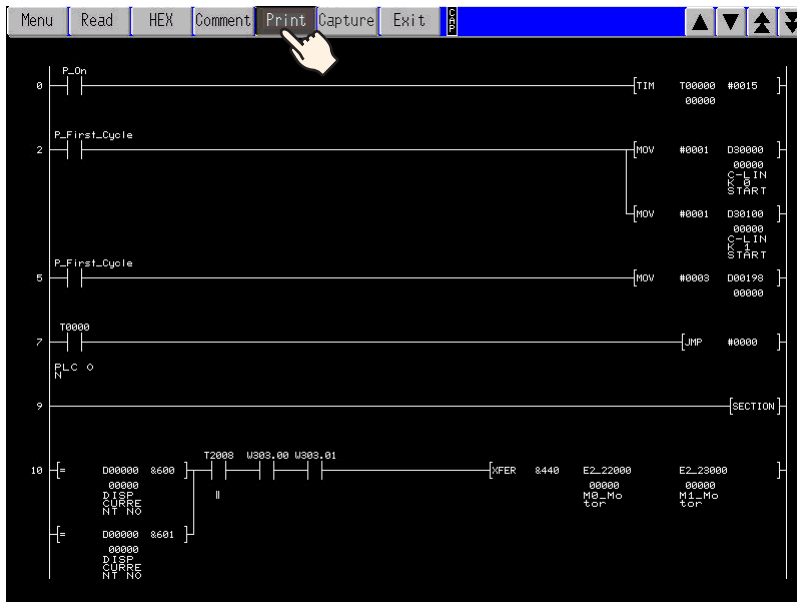

2.5 Capturing and Saving the Ladder Monitor View on a CF Card

2.5.1 Details

You can capture and save the Ladder Monitor screen on a CF Card. This allows you to efficiently save and analyze data.

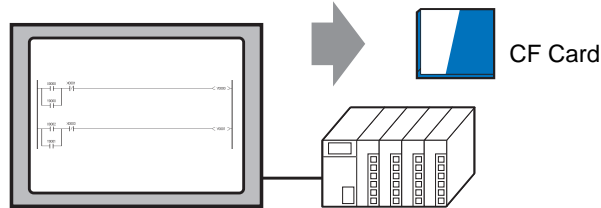

2.5.2 Setup Procedure

1 On the Ladder Monitor main screen, touch [Capture].

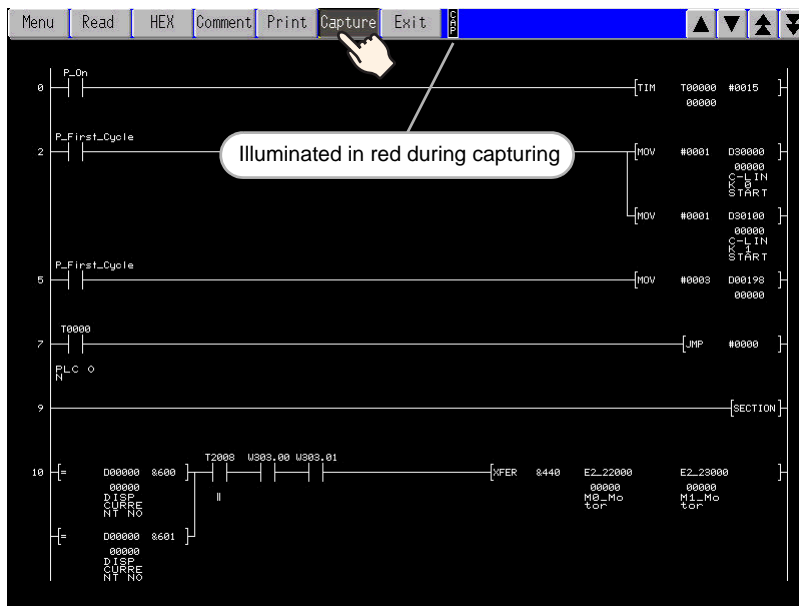

2 The currently displayed screen is captured. A folder titled "CAPTURE" is automatically created in the CF Card root directory (i.e. the top directory), and the data is automatically saved to this folder. The file name is "CP*****_GP.jpg" and ***** is an automatically assigned number from 0 to 65535.

NOTE

- The time required for screen capture differs depending on the image quality and screen size. The file size for an image quality of 80 is approximately 200k bytes, and the capture (snapshot) takes 5 to 6 seconds. To change the image quality, from the GP-Pro EX [System Settings], point to [Display Unit] and select [Mode]. In [Screen/Video Capture Settings] change the [Capture Image Quality] setting.
- If you continuously touch the capture (snapshot) button, the screens may not be captured properly. Allow some time between captures (snapshots).

3



Ladder Monitor Screen Features

| | | |
|-----|-----------------------------|-----|
| 3.1 | Main Screen..... | 3-2 |
| 3.2 | File Selection Screen | 3-6 |
| 3.3 | Menu Screen..... | 3-8 |

3.1 Main Screen

Names and Features on the Main Screen

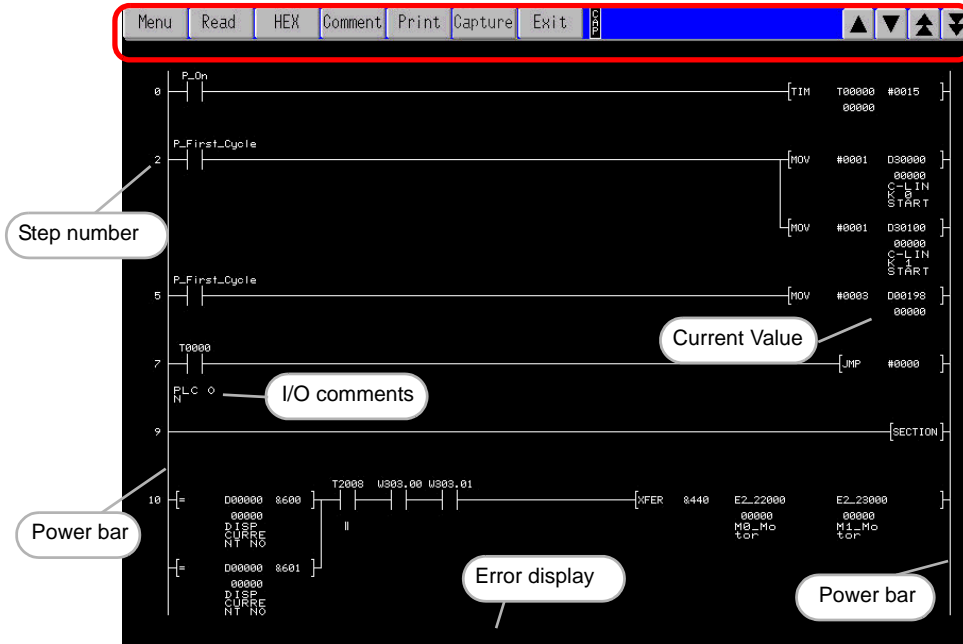

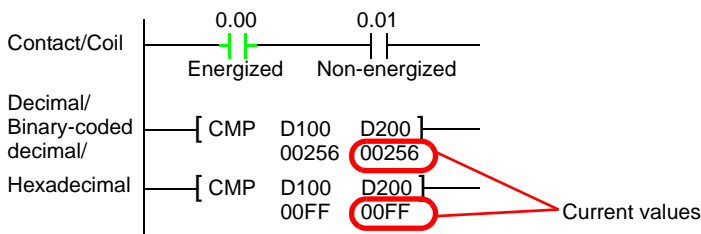

| Setting/Notated Items | Setting/Notated Contents |
|-----------------------|---|
| Menu | This displays the menu screen. For details, see the following pages. ☞ "3.3 Menu Screen" (page 3-8) |
| Read | This displays the file selection screen where you select the ladder program to read. For details, see the following pages. ☞ "3.2 File Selection Screen" (page 3-6) |

Continued

| Setting/Notated Items | Setting/Notated Contents |
|---|---|
| Unsigned decimal/ Signed decimal/ Hexadecimal | <p>This switches between decimal, binary-coded decimal, and hexadecimal current values. The switch display changes between [Decimal] and [Hexadecimal] every time it is touched.</p> <p>NOTE</p> <ul style="list-style-type: none"> Current values are displayed in the following two ways: <ul style="list-style-type: none"> Contact/Coil Displays energized/non-energized state by the thickness of parts lines. An energized state is displayed in bold lines. Decimal/Binary-coded decimal/Hexadecimal Data is displayed in parallel with devices. Current values for bit devices are displayed in bits. Current values for word devices are displayed in words.  |

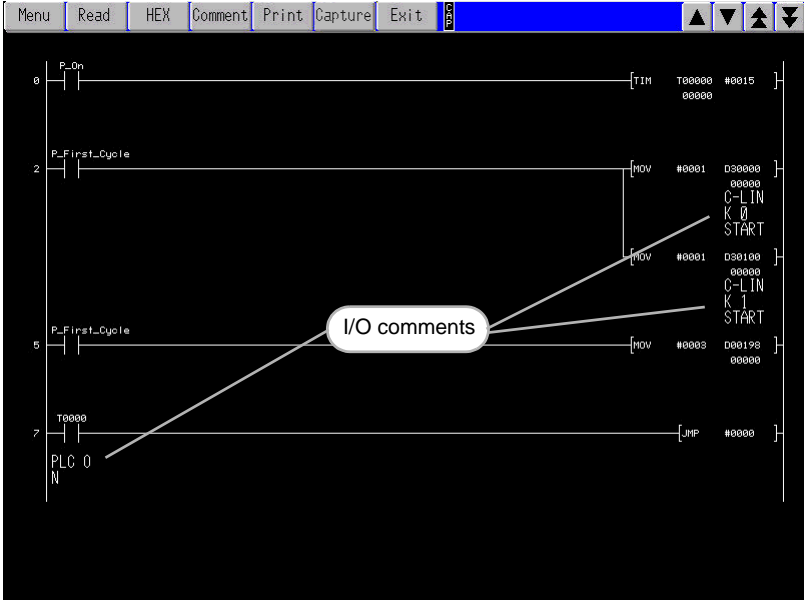
Continued

| Setting/Notated Items | Setting/Notated Contents |
|--|--|
| <p>Comment</p> | <p>This selects the display method for I/O comments.</p> <p>Touch to switch Short Comment Mode --> Compressed Comment Mode -> No Comment Mode in this order.</p> <ul style="list-style-type: none"> • Short comment mode This displays up to 5 single-byte characters x 3 lines of comments. • Compressed comment mode This displays up to 5 single-byte characters x 3 lines of comments. This displays the characters compressed to 1/2 vertical size. • No comment mode This displays no I/O comments.  <p>NOTE</p> <ul style="list-style-type: none"> • To see the full comments when only a portion is displayed, touch the relevant comment. The number of characters displayed in the bottom left of the screen changes depending upon the screen size. |
| Print | This prints the Ladder Monitor screen. |
| Capture | This captures and saves the Ladder Monitor screen to a CF Card. |
| Exit | This closes the Ladder Monitor. |
|  | This scrolls the Ladder Monitor screen line by line. |
|  | This takes you to the previous/next page. |
| <pre>---- [BPRG &0]--- ---- [LD ***]--- ---- [IF ***]--- ---- [ELSE ***]--- ---- [IEND]---</pre> | This shows the block program. When the block program that used the BPRG command appears, CX-Programmer will be displayed at the same time as a mnemonic expression. |
| <pre>---- [FB]---</pre> | This shows the function block. |

Continued

NOTE

- The ladder rungs that you can display differ depending on the comment mode.

| Type | Window Size | No Comments | 16 x 16 Comments | 16 x 8 Comments |
|-------------|--------------------|--------------------|-------------------------|------------------------|
| VGA | 640 x 480 | 10 lines | 4 lines | 6 lines |
| SVGA | 800 x 600 | 13 lines | 5 lines | 8 lines |
| XGA | 1024 x 768 | 17 lines | 7 lines | 10 lines |



3.2 File Selection Screen

Names and Features on the File Selection screen



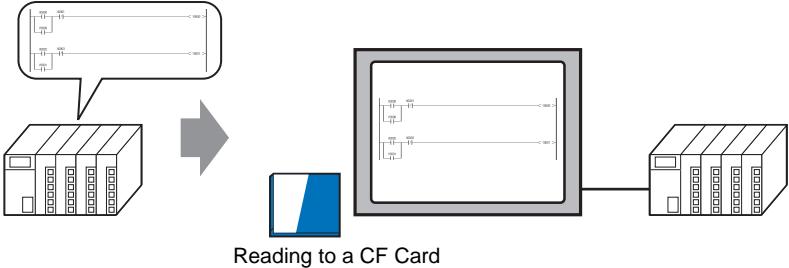

| Setting | | Description |
|----------------|--------------|--|
| Ladder Files | type | This displays the ladder type. CYCLE: Cycle program INTERRUPT: Interrupt program |
| | no. | This displays the ladder number. |
| | program name | This displays the program name. |
| | P | This displays the status of the program property, "Task Reading Protection," and display the presence or absence of reading protection. * : Protected |
| Comment Files | file name | This displays the list of comment files on the CF card. OMR_FINS: Up to 10 single-byte character or 5 double-byte character will be displayed. OMR_FINE: Up to 36 single-byte character or 18 double-byte character will be displayed. |
| | size | This displays the file size up to 8 digits. |
| | date | This displays the update date. |
| | time | This displays the update time. |
| Ladder Storage | PC | This reads the list of ladder programs from the PLC. |
| | CACHE | This reads the list of ladder programs that has been cached on the CF card. |

Continued

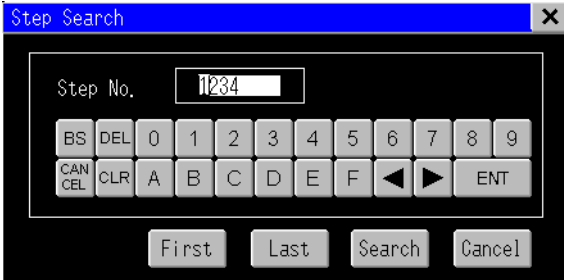

| Setting | Description |
|--|---|
| <p>OK</p> | <p>This reads the ladder programs onto a CF Card.</p> <p>NOTE</p> <ul style="list-style-type: none"> The read button triggers saving of only ladder programs and comments to the CF Card. It always reads and displays the latest numeric values from the external device.  <p>Reading to a CF Card</p> <p>If you change the ladder programs or comments on the PLC after reading the data of the external device to the CF card of the display, the Ladder Monitor for the display will not be updated. Read the data again to update the saved data.</p> <p>Cache the ladder programs on the CF Card to increase the display speed instead of reading data from the external device every time.</p> <ul style="list-style-type: none"> To display the comment line, copy the comment file (*.ocm) into the folder below the CF card. When using CS/CJ Series HOST Link Driver: PLCLDMON\OMR_FINS When using CS/CJ Series Ethernet Driver: PLCLDMON\OMR_FINE ☞ “3.2 File Selection Screen” (page 3-6) <p>When reading and displaying the comment information from the CF card again, convert the comment file created with the Omron Corporation programming tool, CXProgrammer, with the Digital Comment Editor Tool. ☞ “Start up procedure from the 2.2.2 Setup Procedure Step 6” (page 2-8)</p> <p>For details on comment and ladder files, see below. ☞ “3.2 File Selection Screen” (page 3-6)</p> |
| <p> /Cancel</p> | <p>This closes the file selection screen and returns to the previously displayed screen.</p> |

3.3 Menu Screen



| Setting | Description |
|----------------------|---|
| <p>Step Search</p> | <p>This searches by the step number (number of steps) of the ladder program. This displays the ladder program with the specified step number (number of steps) at the top of the screen.</p>  |
| <p>Device Search</p> | <p>This searches by the device address. This displays the ladder program with the specified device address at the top of the screen.</p>  <p>NOTE</p> <ul style="list-style-type: none"> When you touch a device on the screen twice, the [Device Search] dialog box will appear. Using its device address as the key, you can search the desired ladder program. |

Continued

| Setting | Description |
|---|---|
| Coil Search | <p>This searches by output instruction. This displays the ladder program with the specified output instruction at the top of the screen.</p>  |
| Device monitor | This displays the device monitor screen. |
|  | This closes the menu screen and returns to the previously displayed screen. |

NOTE

- For the device monitor feature, see the following manual.
See: GP-Pro EX Reference Manual

4



Restrictions

Ladder Monitor Restrictions

- Depending on the version, your programming tool may not be able to display ladder programs. For the versions supporting programming tools, see the Pro-face support site “Otasuke Pro!”. For the instructions that you can monitor, see the manual of the external device.
- To use this feature, your CF Card must have 256 MB or more of free space.
- When reading the ladder program, you cannot read only the comment file.
- The maximum amount of lines displayed for one ladder program is 25. The 26th line and after are not displayed. If you specify a device located in the 26th line or after when searching for a device, the start of the circuit where the device is located will be displayed but the specified device itself will not be displayed.
- The power flow is shown by the contact/coil in bold, but the lines connecting contacts to contacts do not change.
- The time taken for a screen capture depends on the image quality and screen size. The file size for a screen quality of 80 will be approximately 200 KB and the capture will take about 5 to 6 seconds.
- If you continuously touch the capture (snapshot) button, the screens may not be captured properly. Allow some time between captures (snapshots).
- Ladder program and comment password settings are not supported. When a [Stop Read/Write] password is used, reads will cause a communication error.
- Please use CF Cards manufactured by Pro-face (Digital Electronics Corporation). If using another company’s CF Card, damage may occur to the CF Card data.
- Only English and Japanese can be used for the font.
- Even when the ladder program has been task reading protected, if the task reading protection password in PLC has not been set, reading is possible.
- I/O comments cannot be read from the PLC.
- Instance names of function blocks, function block names that are called, and parameter names will not be displayed.
- The content of function blocks will not be displayed.
- Floating decimal points of monitor values cannot be displayed.
- Other program files besides ladder cannot be read or displayed.

■ Error Messages

| Error Messages | Solution |
|--|---|
| There is no CF-Card in the GP. | Please check if the CF Card is inserted properly. |
| It failed to read a file in the CF-Card. | <ul style="list-style-type: none"> • Please check if the CF Card is inserted properly. • When the ladder program is set as CACHE, it is possible that a cache does not exist on the CF Card. In this case, read the ladder program again. |
| It failed to write a file in the CF-Card. | <ul style="list-style-type: none"> • Please check if the CF Card is inserted properly. • Please check if the CF Card has enough space. • Check that the “PLCLDMON\OMR_FINS” or “PLCLDMON\OMR_FINE” folders on the CF Card are not set to “ReadOnly”. |
| It failed to load the Ladder Monitor. | <ul style="list-style-type: none"> • Please check for damage to the CF Card. • Please format the CF card to either FAT32 or FAT, and try again. |
| The Ladder Monitor can't start because the Runtime version is old. | Use the latest version of GP-Pro EX and download the system to the display. |
| The Ladder Monitor can't start because the version is old. | Install the latest version of the ladder monitor onto the CF card.  “2.2.2 Setup Procedure” (page 2-4) |
| There are unsupported instructions. | This message appears when an instruction is used that is not supported by the Ladder Monitor. Please check the version of the programming tool. |
| The communication error occurred. | Please check if the external device and cables are connected properly. If a password is used in the ladder program file, please remove that password. |
| There is no enough memory. | The comment file size is too large. Please reduce the size of the file. |

