

# Flex Network I/O Unit 32-point Input Sink • Source / 32-point Transistor Output Sink Type Installation Guide

Thank you for purchasing Pro-face's "Flex Network I/O Unit 32-point Input Sink • Source / 32-point Transistor Output Sink Type" (FN-XY32SKS41) unit. To ensure correct use of this unit's functions and features, be sure to carefully read this installation guide and the Flex Network DIO Unit User Manual (downloaded from Pro-face web site).

## Safety Precautions

This guide contains a variety of safety markings for safe and correct operation of this unit. Please read this installation guide and any related manuals carefully to fully understand how to correctly use this unit's functions.

### ■ Safety Symbols

This guide uses the following symbols for important information related to the safe and correct operation of this unit. Please pay attention to these symbols and follow all instructions given.

Safety symbols and their meanings:



### **Danger**

A hazardous situation that could result in serious injury or even death if instructions are not followed.



### **Warning**

A potentially hazardous situation that could result in serious injury or even death if instructions are not followed.



### **Caution**

A potentially hazardous situation that could result in minor injury or equipment damage if instructions are not followed.

## **Danger**

- An emergency stop circuit and an interlock circuit should be constructed outside of this unit. Constructing these circuits inside this unit may cause a runaway situation, system failure, or an accident due to unit failure.
- Systems using this unit should be designed so that output signals which could cause a serious accident are monitored from outside the unit.
- This unit is designed to be a general-purpose device for general industries, and is neither designed nor produced to be used with equipment or systems in potentially life-threatening conditions. If you are considering using this unit for special uses, including nuclear power control devices, electric power devices, aerospace equipment, medical life support equipment, or transportation vehicles, please contact your local Flex Network distributor.

## **Warning**

- Whenever installing, dismantling, wiring, and conducting maintenance or inspections, be sure to disconnect power to this unit to prevent the possibility of electric shock or fire.
- Do not disassemble or remodel this unit, since it may lead to an electric shock or fire.
- Do not use this unit in an environment that contains flammable gases since an explosion may occur.
- Do not use this unit in an environment that is not specified in either the Installation Guide or User Manual. Otherwise, an electric shock, fire, malfunction or other failure may occur.
- Because of the possibility of an electric shock or malfunction, do not touch any power terminals while the unit is operating.

## **CAUTIONS**

- Communication cables or I/O signal lines must be wired separately from the main circuit (high-voltage, large-current) line, high-frequency lines such as inverter lines, and the power line. Otherwise, a malfunction may occur due to noise.
- This unit must be properly installed according to directions in the installation guide and user's manual. Improper installation may cause the unit to malfunction, or fail.
- This unit must be properly wired according to directions in the Installation Guide and User Manual. Improper wiring may cause a malfunction, failure or electric shock.
- Do not allow foreign substances, including chips, wire pieces, water, or liquids to enter inside this unit's case. Otherwise, a malfunction, failure, electric shock, or fire may occur.
- When disposing of this unit, handle it as industrial waste.

### ■ To Avoid Damage

- Avoid storing or operating this unit in either direct sunlight or excessively dusty or dirty environments.
- Because this unit is a precision instrument, do not store or use it in locations where excessive shocks or vibration may occur.
- Avoid covering this unit's ventilation holes, or operating it in an environment that may cause it to overheat.
- Avoid operating this unit in locations where sudden temperature changes can cause condensation to form inside the unit.
- Do not use paint thinner or organic solvents to clean this unit.

## Package Contents

### ■ Flex Network I/O Unit

**32-point Input Sink • Source /  
32-point Transistor Output  
Sink Type (FN-XY32SKS41)**

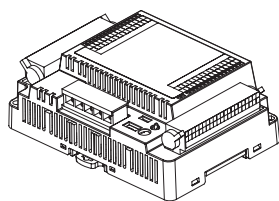

### ■ Flex Network I/O Unit

**32-point Input Sink • Source /  
32-point Transistor Output  
Sink Type Installation Guide  
(this guide)**

Installation  
Guide

## Driver & Manual

The driver for the Flex Network Unit is required in order to use the unit.

For GLC2000 series and LT series,

You can select the Flex Network Driver via GP-PRO/PBIII C-Package (Pro-Control Editor) or LT Editor.

If the selection of the appropriate unit's name does not appear in the [I/O Configuration] - [I/O Unit Settings] area, you will need to update the driver file.

You can download the latest driver from Pro-face's Home Page.

For GP3000 Series,

You can select the Flex Network Driver via GP-Pro EX as an I/O driver.

Also, you can download the driver and the Flex Network DIO Unit User Manual from Pro-face's web site. (<http://www.pro-face.com/>)

## Maintenance Item

- ### ■ DIO Connector (Spring Type) (GLC-DIOCN03) (a set of two (2) connectors)

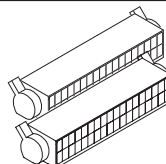

# UL/c-UL(CSA) Application Notes

The FN-XY32SKS41 is a UL/c-UL (CSA) recognized unit.  
(UL File No. E220851)

The FN-XY32SKS41 unit conforms to the following standards.

- UL508 Electrical Control System for Industry
- CAN/CSA-C22.2, No.1010.1  
(Safety requirements for electrical equipment for measurement and laboratory use)

FN-XY32SKS41(UL Resistration Model: 3080057-01)

<Notes>

- Only use the unit installed with other equipment.
- If the unit is installed in an area with no air conditioning system, be sure to install it in a vertical panel using a DIN rail or mounting holes. Also, be sure the unit is installed so it is at least 100 mm away from any adjacent structures or devices. If these requirements are not met, the heat generated by the unit's internal components may cause the unit to fail to meet UL standards requirements.
- The power supply unit connected to the I/O unit must be a UL/c-UL (CSA) approved Class 2 power supply unit or Class 2 transformer\*<sup>1</sup>. When the GLC/LT/GP3000 or multiple I/O units under load are operated with a single power supply, the amount of current consumption and full-load current of the I/O units must be within the rated load of the Class 2 power supply unit or Class 2 power supply transformer. Be aware that the number of points which can be turned ON simultaneously may be limited, depending on the amount of load and load current value.

## CE Marking Notes

The FN-XY32SKS41 is a CE Marked unit that conforms to EMC directives EN55011 Class A and EN61000-6-2.

<Caution>

While this unit is officially marked as conforming to the relevant EMC directives, it is the user's final application of this unit in a larger system (i.e. the machinery, wiring, control panel, installation method, etc.) that will determine if this unit maintains or loses this conformance marking. Therefore, it is strongly advised that the user investigate and confirm whether their overall system (i.e. all related machinery and equipment) also conforms with these EMC directives.

---

*\*1 The National Electrical Code states that Class 2 power supplies and Class 2 transformers should not exceed an output of 30V, and at 8A or less, should not exceed 100VA.*

# 1 External Dimensions/ Part Names

This section shows the external dimensions of the I/O unit, part names and part settings.

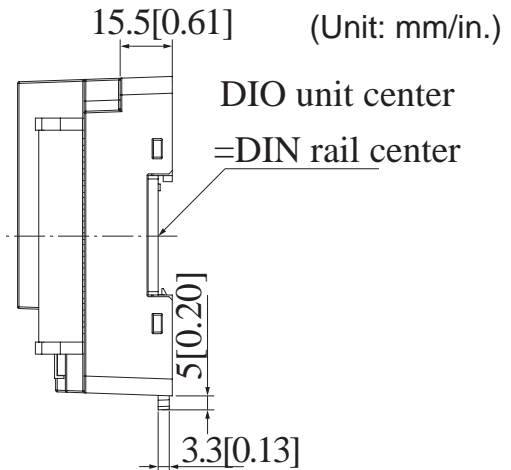
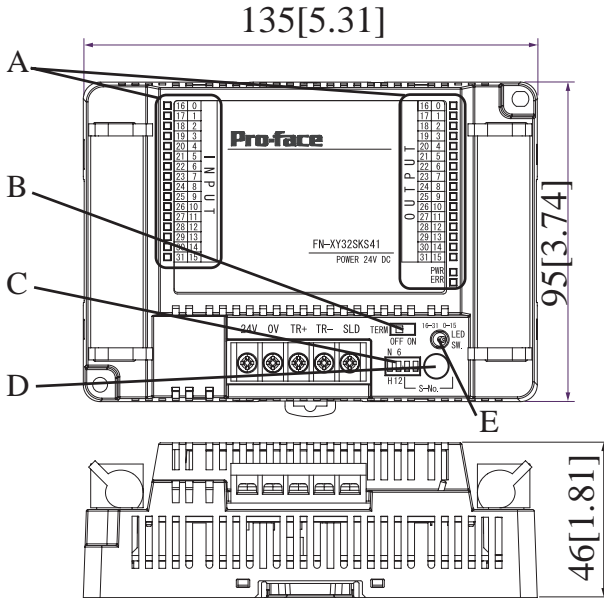

Factory (Default) settings  
 Communication speed:6 Mbps  
 S-No.(station No.):0  
 Output hold:Non Hold

- A: Status LED ..... Indicates the unit's current operation status.
- B: Terminal Switch..... Changes termination ON/OFF. Turns ON only the unit connected at the end of the communication cable.
- C: Dip Switches ..... Set communication speeds and S-No. (first digit).
- D: Rotary Switch ..... Sets S-No.(station no.) (last digit).
- E: IN/OUT LED Changeover Switch ..... The IN/OUT LED can be switched between IN/OUT ("0-15" & "16-31").

## ◆ Switch Settings



OFF Termination OFF,  
 ON Termination ON



SW1 N...Non Hold,  
 H...Hold  
 SW2 6 ..... 6 Mbps,  
 12 ..... 12 Mbps

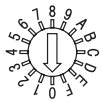

SW3, 4 First ..... ON (1),  
 Last ..... OFF (0)  
 Arrow tie Setting values  
 (0 to F)



"0-15", "16-31" (IN/OUT)



**When a logic program switches from RUN mode to OFFLINE mode, the GLC/LT/GP3000 and I/O signals operate as shown below regardless of the output hold settings. Therefore, be sure to consider this operation before resetting the unit or switching to OFFLINE mode.**

		→		
GLC/LT/GP3000 mode		RUN	OFFLINE	RUN
I/O signal	ON	Logic Program Output	OFF	Logic Program Output
	OFF			

**However, when performing Reset, the I/O signal OFF timing will change.**

## 2 Specifications

### ■ Electrical (control section)

<b>Rated Voltage</b>	DC24V
<b>Rated Voltage Range</b>	DC20.4 to DC28.8V
<b>Allowable Voltage Interruption</b>	10ms or less (Power supply: DC24V)
<b>Power Consumption</b>	3.5W or less
<b>Voltage Endurance</b>	AC500V 10mA 1minute (between power/Input and Output, and FG terminals)
<b>Insulation Resistance</b>	DC500V at 10M $\Omega$ or higher (between power/Input and Output, and FG terminals)
<b>In-rush Current</b>	15A or less

### ■ Environmental

<b>Operating Temperature</b>	0°C to 55°C
<b>Storage Temperature</b>	-25°C to +70°C
<b>Operating Humidity</b>	5% RH to 95% RH (non-condensing), wet bulb temperature: less than 39°C
<b>Storage Humidity</b>	5% RH to 95% RH (non-condensing), wet bulb temperature: less than 39°C
<b>Air Purity (Dust)</b>	0.1mg/m <sup>3</sup> or less (non-conductive levels)
<b>Pollution Degree</b>	Pollution Degree 2
<b>Protection Rating</b>	IP20 (Without terminal block)

■ Input/Output

Input	Rated Input Voltage		DC24V	
	Max. Input Voltage		DC28.8V	
	No. of Input Points		32 points (sink/source type - dual use)	
	NO. of Common		2	
	Input ON Voltage		DC15V or higher	
	Input OFF Voltage		DC5V or less	
	Input Impedance		4.2k $\Omega$	
	Input Derating		Refer to ◆ Input Derating	
	Isolation Method		Photocoupler Isolation	
	Input Delay Time		OFF-ON	1.5ms or less
ON-OFF			1.5ms or less	
Output	Rated Output Voltage		DC24V	
	Rated Output Voltage Range		DC20.4V to DC28.8V	
	No. of Output Points		32 points (sink type)	
	NO. of Common		2	
	Maximum Load Voltage		0.2A/1 point(16 points/1 common, max. common current :1.6A)	
	Isolation Method		Photocoupler Isolation	
	Output Protection		None	
	Built-in Fuse		3.5A, DC125V built-in Chip Fuse (cannot be replaced)	
	Voltage Drop (ON Voltage)		DC1.5V or less	
	Clamp Voltage		DC39V $\pm$ 1V	
	Current Leakage		0.1mA or less	
	Output Delay Time		OFF-ON	1ms or less
			ON-OFF	1ms or less
No. of Exclusive Use Nodes		4		

◆ Input Derating

Using FN-XY32SKS41 at levels in excess of the Rated Input Voltage, Input ON Voltage, No. of Input Points, Operating Temperature and so on, can cause the product's input parts to malfunction. To prevent a malfunction, Input Derating should be set within that range. (See below.)

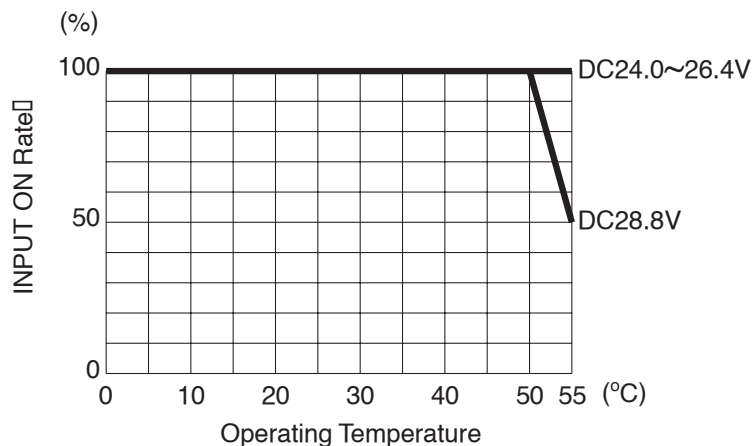

### 3 Input/Output Circuit Connection Drawing

The drawing shows the connection between the input section and the sink output type.

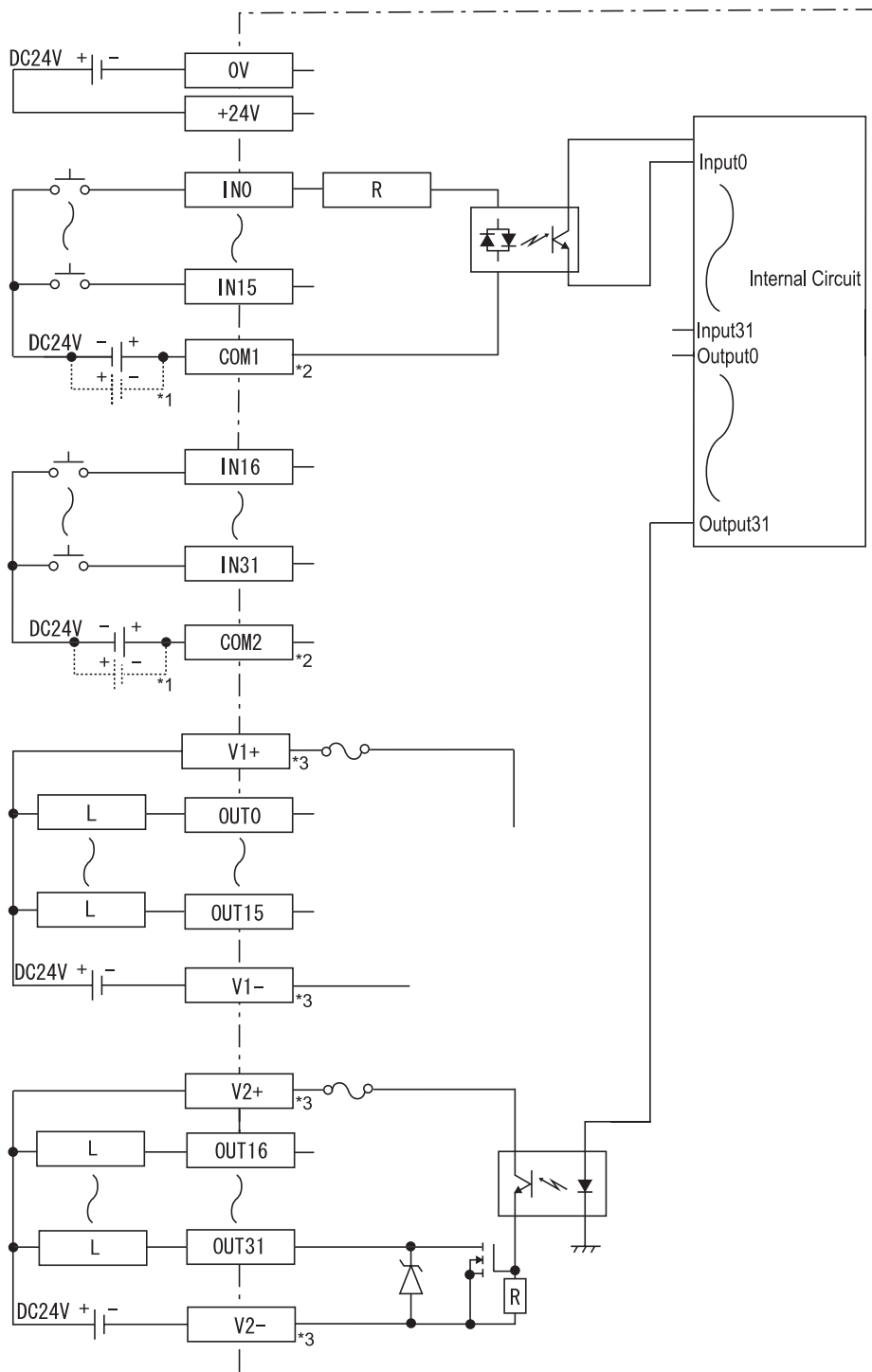

**Note:** Be sure to separate the I/O unit's power and output lines, and sensor power lines to prevent the unit from receiving excessive levels of noise.

\*1 Dotted line shows the source output connection.

\*2 For IN0 to IN15, use COM1.

For IN16 to IN31, use COM2 as the input common.

\*3 For OUT0 to OUT15, connect the output power to V1+/V1-.

For OUT16 to OUT31, connect the output power to V2+/V2-.



One connector has an INPUT label and the other has an OUTPUT label.  
Each connector's pin assignments are as follows;

◆ **INPUT Label Pin Assignments**

INPUT Label	Label Signal Names	Signal Name	Description	Label Signal Name	Signal Name	Description																																				
<table border="1" style="display: inline-table; vertical-align: middle;"> <tr><td>1</td><td>0</td></tr> <tr><td>3</td><td>2</td></tr> <tr><td>5</td><td>4</td></tr> <tr><td>7</td><td>6</td></tr> <tr><td>9</td><td>8</td></tr> <tr><td>11</td><td>10</td></tr> <tr><td>13</td><td>12</td></tr> <tr><td>15</td><td>14</td></tr> <tr><td>NC</td><td>C1</td></tr> <tr><td>17</td><td>16</td></tr> <tr><td>19</td><td>18</td></tr> <tr><td>21</td><td>20</td></tr> <tr><td>23</td><td>22</td></tr> <tr><td>25</td><td>24</td></tr> <tr><td>27</td><td>26</td></tr> <tr><td>29</td><td>28</td></tr> <tr><td>31</td><td>30</td></tr> <tr><td>NC</td><td>C2</td></tr> </table>	1	0	3	2	5	4	7	6	9	8	11	10	13	12	15	14	NC	C1	17	16	19	18	21	20	23	22	25	24	27	26	29	28	31	30	NC	C2	1	IN1	INPUT1	0	IN0	INPUT0
	1	0																																								
	3	2																																								
	5	4																																								
	7	6																																								
	9	8																																								
	11	10																																								
	13	12																																								
	15	14																																								
	NC	C1																																								
	17	16																																								
	19	18																																								
	21	20																																								
	23	22																																								
	25	24																																								
	27	26																																								
	29	28																																								
	31	30																																								
NC	C2																																									
3	IN3	INPUT3	2	IN2	INPUT2																																					
5	IN5	INPUT5	4	IN4	INPUT4																																					
7	IN7	INPUT7	6	IN6	INPUT6																																					
9	IN9	INPUT9	8	IN8	INPUT8																																					
11	IN11	INPUT11	10	IN10	INPUT10																																					
13	IN13	INPUT13	12	IN12	INPUT12																																					
15	IN15	INPUT15	14	IN14	INPUT14																																					
NC	NC	Reserved	C1	COM1	INPUT Common (for IN0 to IN15)																																					
17	IN17	INPUT17	16	IN16	INPUT16																																					
19	IN19	INPUT19	18	IN18	INPUT18																																					
21	IN21	INPUT21	20	IN20	INPUT20																																					
23	IN23	INPUT23	22	IN22	INPUT22																																					
25	IN25	INPUT25	24	IN24	INPUT24																																					
27	IN27	INPUT27	26	IN26	INPUT26																																					
29	IN29	INPUT29	28	IN28	INPUT28																																					
31	IN31	INPUT31	30	IN30	INPUT30																																					
NC	NC	Reserved	C2	COM2	INPUT Common (for IN16 to IN31)																																					

◆ **OUTPUT Label Pin Assignments**

OUTPUT Label	Label Signal Names	Signal Name	Description	Label Signal Names	Signal Name	Description																																				
<table border="1" style="display: inline-table; vertical-align: middle;"> <tr><td>0</td><td>1</td></tr> <tr><td>2</td><td>3</td></tr> <tr><td>4</td><td>5</td></tr> <tr><td>6</td><td>7</td></tr> <tr><td>8</td><td>9</td></tr> <tr><td>10</td><td>11</td></tr> <tr><td>12</td><td>13</td></tr> <tr><td>14</td><td>15</td></tr> <tr><td>V1+</td><td>V1-</td></tr> <tr><td>16</td><td>17</td></tr> <tr><td>18</td><td>19</td></tr> <tr><td>20</td><td>21</td></tr> <tr><td>22</td><td>23</td></tr> <tr><td>24</td><td>25</td></tr> <tr><td>26</td><td>27</td></tr> <tr><td>28</td><td>29</td></tr> <tr><td>30</td><td>31</td></tr> <tr><td>V2+</td><td>V2-</td></tr> </table>	0	1	2	3	4	5	6	7	8	9	10	11	12	13	14	15	V1+	V1-	16	17	18	19	20	21	22	23	24	25	26	27	28	29	30	31	V2+	V2-	0	OUT0	OUTPUT0	1	OUT1	OUTPUT1
	0	1																																								
	2	3																																								
	4	5																																								
	6	7																																								
	8	9																																								
	10	11																																								
	12	13																																								
	14	15																																								
	V1+	V1-																																								
	16	17																																								
	18	19																																								
	20	21																																								
	22	23																																								
	24	25																																								
	26	27																																								
	28	29																																								
	30	31																																								
V2+	V2-																																									
2	OUT2	OUTPUT2	3	OUT3	OUTPUT3																																					
4	OUT4	OUTPUT4	5	OUT5	OUTPUT5																																					
6	OUT6	OUTPUT6	7	OUT7	OUTPUT7																																					
8	OUT8	OUTPUT8	9	OUT9	OUTPUT9																																					
10	OUT10	OUTPUT10	11	OUT11	OUTPUT11																																					
12	OUT12	OUTPUT12	13	OUT13	OUTPUT13																																					
14	OUT14	OUTPUT14	15	OUT15	OUTPUT15																																					
V1+	V1+	OUTPUT POWER +24V (for OUT0 to OUT15)	V1-	V1-	OUTPUT POWER 0V (for OUT0 to OUT15)																																					
16	OUT16	OUTPUT16	17	OUT17	OUTPUT17																																					
18	OUT18	OUTPUT18	19	OUT19	OUTPUT19																																					
20	OUT20	OUTPUT20	21	OUT21	OUTPUT21																																					
22	OUT22	OUTPUT22	23	OUT23	OUTPUT23																																					
24	OUT24	OUTPUT24	25	OUT25	OUTPUT25																																					
26	OUT26	OUTPUT26	27	OUT27	OUTPUT27																																					
28	OUT28	OUTPUT28	29	OUT29	OUTPUT29																																					
30	OUT30	OUTPUT30	31	OUT31	OUTPUT31																																					
V2+	V2+	OUTPUT POWER +24V (for OUT16 to OUT31)	V2-	V2-	OUTPUT POWER 0V (for OUT16 to OUT31)																																					

# 4 Installation

## ■ Installing on a DIN rail:

The following information explains how to attach a 35mm DIN rail to the unit.

### ◆ Attachment

Place the unit's curved, top lip over the top of the DIN rail, and then tilt the unit down until the bottom face attachment clip clicks into place.

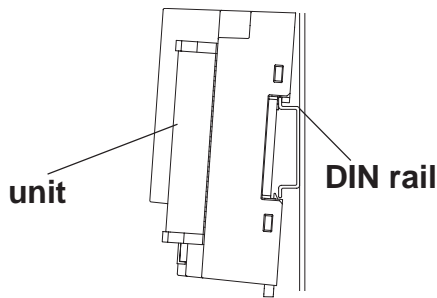

### ◆ Removal

Use a standard screwdriver to force the unit's attachment clip down until the bottom of the unit is freed from the rail. Next, tilt the unit up and remove.

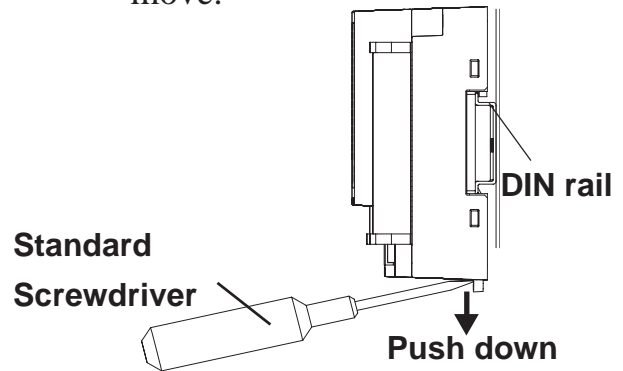

- **Be sure that the top and bottom faces of the unit are facing the correct direction and the unit is installed in a vertical position. Incorrect installation may prevent heat from dissipating.**
- **The unit's attachment clip can be set to remain open. When attaching the unit, be sure to close the attachment clip completely and confirm that the I/O unit is set securely on the DIN rail.**



The I/O unit can be attached to the rear of a GLC2300 series unit or a GP-3300 Series unit.

**Reference** Flex Network DIO Unit User Manual

## ■ Installing in a panel:

Create a panel cut for installing the unit, using the dimensions given below. Secure the I/O unit in place with M4 size screws. The torque should be 0.5 to 1.3 N•m.

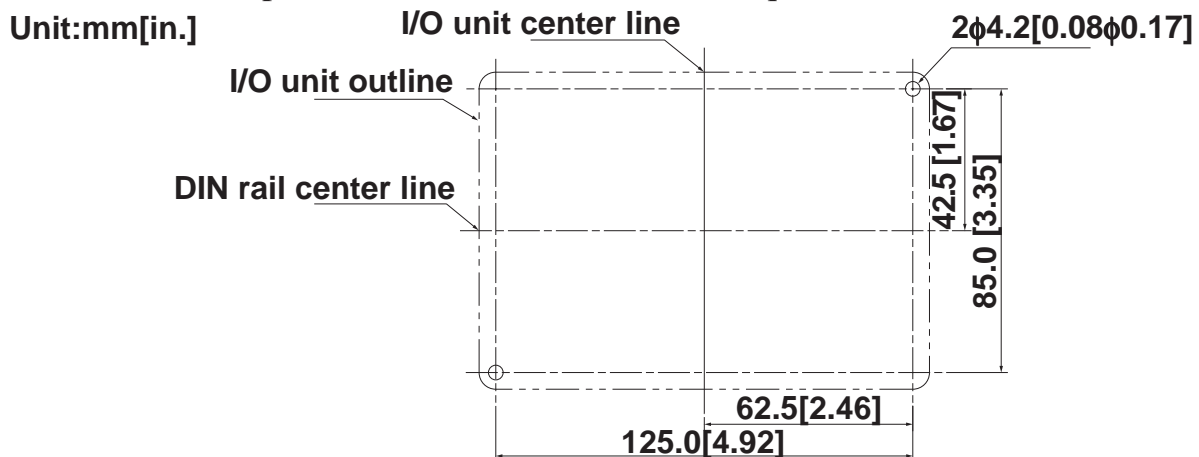

## 5 Wiring

This section describes the cables used for wiring each type of cable.



**Important**

**Do not allow the wire pieces to fall inside the unit.**

### ■ Flex Network Communication Cable

The Flex Network Interface and the I/O unit, or all distributed I/O units, are connected using a cross wiring system. (T-type systems cannot be used.)

Use the following types of communication cables.

Distributor	Order Code	Length
Pro-face	FN-CABLE2010-31-MS	10m
	FN-CABLE2050-31-MS	50m
	FN-CABLE2200-31-MS	200m

When preparing the cable wire ends:

- Cover shielded wires with shield tape or with an insulation tube.
- Use insulated crimp terminals.
- The required torque for securing ring terminals is 0.3 to 0.5 N•m.
- Up to 2 ring terminals can be attached to a single terminal screw.
- If you use a crimp-type terminal without insulation, cover it with a shield tape or an insulation tube. Cover uninsulated crimp terminals with shield tape or tube-type insulation.



**Important**

**Check that all I/O Unit terminal screws are securely tightened, even if they are not used.**

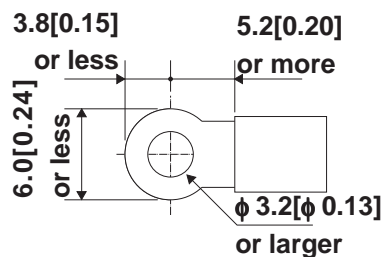
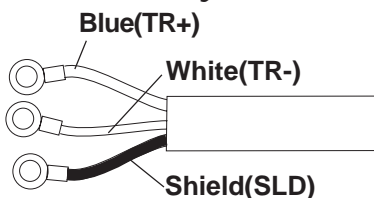

Unit: mm[in.]

### ■ Power Cable

- Use thick lines (max. 1.25mm<sup>2</sup>[0.0024in<sup>2</sup>]) and be sure to twist the wire ends to reduce noise.  
Applicable wire sizes are UL1015 and UL1007.
- Use the same type crimp terminals as used for the communication cable (described above).

### ■ I/O Cable

- Connect the cable to the connectors, the spring clamp type.  
Wire should be AWG22 to AWG18 thick, and twisted. Applicable wire sizes are UL1015 and UL1007.



**Important**

**Be sure to remove the unit's connectors prior to starting wiring. Failing to do so may cause an electric shock.**

- Be sure to strip from 6.5 to 8.0mm [0.26 to 0.31 in.] of cover from the wire.
- Require a Screwdriver;  
Recommended type: SDI (Product No. 900837) <Weidmuller Japan>  
If another manufacturer is used, be sure it has the following dimensions:  
point depth: 0.4mm  
point height: 2.5mm  
length from the point to the handle: 80mm  
Point shape should be DIN5264A, and meet Security Standard DN EN60900.  
Also, the screwdriver's tip should be shaped as follows:

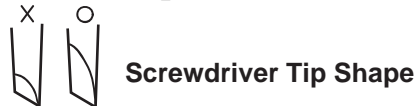

The connectors are a spring clamp type. Use the following procedure to connect the wires to the connectors.

- 1) Insert the screwdriver into the square-shaped hole.  
This will open the wire's round-shaped hole.
- 2) Hold the screwdriver and insert the wire into the wire's round-shaped hole.
- 3) Take out the screwdriver from the square-shaped hole.  
The round-shaped hole will then close, and the wire will be held securely in place.

To remove the wire, re-insert the screwdriver into the square-shaped hole and when the wire's spring clamp releases, pull the wire out.

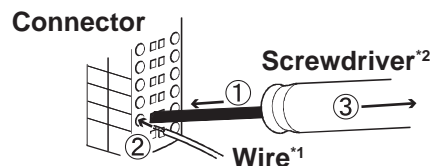

- **Insert each wire completely into its opening. Failure to do so can lead to a unit malfunction or short, either against wire filaments, or against an electrode.**
- **Do not solder the wire itself. This could lead to a bad or poor contact.**

\*1 Be sure to strip only the amount of cover required.

If too much cover is removed, the end wires may short against each other, or against an electrode, which can create an electric shock.

If not enough cover is removed the wire cannot carry a charge.

\*2 Do not rotate the point of the screwdriver inside the square-shaped opening. It may cause a malfunction.

### Note

Please be aware that Digital Electronics Corporation shall not be held liable by the user for any damages, losses, or third party claims arising from the uses of this product.

Digital Electronics Corporation

8-2-52 Nanko Higashi, Suminoe-ku, Osaka 559-0031, Japan

URL: <http://www.pro-face.com/>