

# OMRON

## Smart Sensor

Wide Laser Beam CCD Measurement Sensor

ZX-GT Series

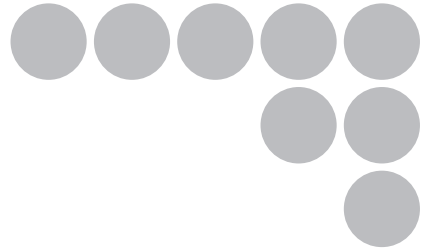

## User's Manual



Cat. No. Z263-E1-03

# Introduction

---

Thank you for purchasing the ZX-GT series.

This manual provides information regarding functions, performance and operating methods that are required for using the ZX-GT.

When using the ZX-GT, be sure to observe the following:

- The ZX-GT must be operated by personnel knowledgeable in electrical engineering.
- To ensure correct use, please read this manual thoroughly to deepen your understanding of the product.
- Please keep this manual in a safe place so that it can be referred to whenever necessary.

# User's Manual

APPRICATION CONSIDERATIONS (Please read)	
BEFORE USE	<b>1</b>
BASIC OPERATIONS	<b>2</b>
FUNCTION SETTINGS	<b>3</b>
COMMUNICATIONS WITH EXTERNAL DEVICES	<b>4</b>
APPENDICES	<b>5</b>

Smart Sensor

Wide Laser Beam CCD Measurement Sensor  
ZX-GT Series

# Terms and Conditions Agreement

## **Warranty, Limitations of Liability**

### **WARRANTY**

#### **Exclusive Warranty**

Omron's exclusive warranty is that the Products will be free from defects in materials and workmanship for a period of twelve months from the date of sale by Omron (or such other period expressed in writing by Omron). Omron disclaims all other warranties, express or implied.

#### **Limitations**

OMRON MAKES NO WARRANTY OR REPRESENTATION, EXPRESS OR IMPLIED, ABOUT NON-INFRINGEMENT, MERCHANTABILITY OR FITNESS FOR A PARTICULAR PURPOSE OF THE PRODUCTS. BUYER ACKNOWLEDGES THAT IT ALONE HAS DETERMINED THAT THE PRODUCTS WILL SUITABLY MEET THE REQUIREMENTS OF THEIR INTENDED USE.

Omron further disclaims all warranties and responsibility of any type for claims or expenses based on infringement by the Products or otherwise of any intellectual property right.

#### **Buyer Remedy**

Omron's sole obligation hereunder shall be, at Omron's election, to (i) replace (in the form originally shipped with Buyer responsible for labor charges for removal or replacement thereof) the non-complying Product, (ii) repair the non-complying Product, or (iii) repay or credit Buyer an amount equal to the purchase price of the non-complying Product; provided that in no event shall Omron be responsible for warranty, repair, indemnity or any other claims or expenses regarding the Products unless Omron's analysis confirms that the Products were properly handled, stored, installed and maintained and not subject to contamination, abuse, misuse or inappropriate modification. Return of any Products by Buyer must be approved in writing by Omron before shipment. Omron Companies shall not be liable for the suitability or unsuitability or the results from the use of Products in combination with any electrical or electronic components, circuits, system assemblies or any other materials or substances or environments. Any advice, recommendations or information given orally or in writing, are not to be construed as an amendment or addition to the above warranty.

See <http://www.omron.com/global/> or contact your Omron representative for published information.

### **Limitation on Liability; Etc**

OMRON COMPANIES SHALL NOT BE LIABLE FOR SPECIAL, INDIRECT, INCIDENTAL, OR CONSEQUENTIAL DAMAGES, LOSS OF PROFITS OR PRODUCTION OR COMMERCIAL LOSS IN ANY WAY CONNECTED WITH THE PRODUCTS, WHETHER SUCH CLAIM IS BASED IN CONTRACT, WARRANTY, NEGLIGENCE OR STRICT LIABILITY.

Further, in no event shall liability of Omron Companies exceed the individual price of the Product on which liability is asserted.

### **Application Considerations**

#### **Suitability of Use**

Omron Companies shall not be responsible for conformity with any standards, codes or regulations which apply to the combination of the Product in the Buyer's application or use of the Product. At Buyer's request, Omron will provide applicable third party certification documents identifying ratings and limitations of use which apply to the Product. This information by itself is not sufficient for a complete determination of the suitability of the Product in combination with the end product, machine, system, or other application or use. Buyer shall be solely responsible for determining appropriateness of the particular Product with respect to Buyer's application, product or system. Buyer shall take application responsibility in all cases.

NEVER USE THE PRODUCT FOR AN APPLICATION INVOLVING SERIOUS RISK TO LIFE OR PROPERTY WITHOUT ENSURING THAT THE SYSTEM AS A WHOLE HAS BEEN DESIGNED TO ADDRESS THE RISKS, AND THAT THE OMRON PRODUCT(S) IS PROPERLY RATED AND INSTALLED FOR THE INTENDED USE WITHIN THE OVERALL EQUIPMENT OR SYSTEM.

#### **Programmable Products**

Omron Companies shall not be responsible for the user's programming of a programmable Product, or any consequence thereof.

## **Disclaimers**

### **Performance Data**

Data presented in Omron Company websites, catalogs and other materials is provided as a guide for the user in determining suitability and does not constitute a warranty. It may represent the result of Omron's test conditions, and the user must correlate it to actual application requirements. Actual performance is subject to the Omron's Warranty and Limitations of Liability.

### **Change in Specifications**

Product specifications and accessories may be changed at any time based on improvements and other reasons. It is our practice to change part numbers when published ratings or features are changed, or when significant construction changes are made. However, some specifications of the Product may be changed without any notice. When in doubt, special part numbers may be assigned to fix or establish key specifications for your application. Please consult with your Omron's representative at any time to confirm actual specifications of purchased Product.

### **Errors and Omissions**

Information presented by Omron Companies has been checked and is believed to be accurate; however, no responsibility is assumed for clerical, typographical or proofreading errors or omissions.

## Meanings of Signal Words

The following signal words are used in this manual.





Indicates a potentially hazardous situation which, if not avoided, will result in minor or moderate injury, or may result in serious injury or death. Additionally there may be significant property damage.



Indicates a potentially hazardous situation which, if not avoided, may result in minor or moderate injury or in property damage.

## Meanings of Alert Symbols

The following alert symbols are used in this manual.

	Indicates general prohibitions for which there is no specific symbol.
	Indicates the possibility of laser radiation.
	Indicates prohibition when there is a risk of minor injury from electrical shock or other source if the product is disassembled.

 **WARNING**

This product is not designed or rated for ensuring safety of persons.  
Do not use it for such purposes.



 **CAUTION**

Never look into the laser beam. Doing so continuously will result in visual impairment.



Do not attempt to dismantle, pressurize, or incinerate the product. Doing so may cause the laser beam to leak, resulting in the danger of visual impairment.





# Precautions for Safe Use

The following points are important to ensure safety, so make sure that they are strictly observed.

## 1. Installation Environment

- Do not use the product in environments where it can be exposed to inflammable/explosive gas.
- To secure the safety of operation and maintenance, do not install the product close to high-voltage devices and power devices.
- Install the product in such a way that its ventilation holes are not blocked. (excluding the connecting surface when the products are connected to each other)
- Tighten the mounting screws with a torque specified in this manual.

## 2. Power Supply and Wiring

- The voltage and AC power supply must be within the rated range (24 VDC +10%, -15%).
- Reverse connection of the power supply is not allowed. Connection to an AC power supply is also not allowed.
- The output load should not be short-circuited.
- Use the power supply within the rated load.
- High-voltage lines and power lines must be wired separately from this product. Wiring them together or placing them in the same duct may cause induction, resulting in malfunction or damage.
- Use the product within the power supply voltage specified by this manual.
- Use a DC power supply with safety measures against high-voltage spikes (safety extra low-voltage circuits on the secondary side).
- Use only combinations of the Sensor and Controller specified in this manual.



Controller Specifications p.133

- When connecting Controllers to each other, use only combinations of the Controllers specified in this manual.



Connecting Controllers to each other p.37

- Connect the exclusive device (Sensor). The product might break down or malfunction if you use a part not included in the exclusive products.

## 3. Applicable standards

- EN61326-1
- Electromagnetic environment : Industrial electromagnetic environment (EN/IEC 61326-1 Table 2)
- There may be cases that current output or voltage output fluctuate within 1%F.S when a sensor is experienced electromagnetic interference.

## 4. Other

- Do not disassemble, repair, modify, pressurize, or incinerate the product.
- Dispose of this product as industrial waste.
- Should you notice any abnormalities, immediately stop use, turn OFF the power supply, and contact your OMRON representative.

# Precautions for Correct Use

Observe the following precautions to prevent failure to operate, malfunctions, or undesirable effects on product performance.

## 1. Installation Site

Do not install this product in locations subjected to the following conditions:

- Ambient temperature outside the rating
- Rapid temperature fluctuations (causing condensation)
- Relative humidity outside the range of 35 to 85%
- Direct vibration or shock
- Reflection of intense light (such as other laser beams or electric arc-welding machines)
- Direct sunlight or near heaters
- Strong magnetic or electric field

Also, do not install this product in locations subjected to the following conditions due to the degree of protection specified in the ratings:

- Presence of corrosive or flammable gases
- Presence of dust, salt, or iron particles
- Water, oil, or chemical fumes or spray

## 2. Power Supply and Wiring

- When using a commercially available switching regulator, make sure that the FG terminal is grounded.
- If surge currents are present in the power lines, connect surge absorbers that suit the operating environment.
- Before turning ON the power after the product is connected, make sure that the power supply voltage is correct, there are no incorrect connections (e.g. load short-circuit), and the load current is appropriate. Incorrect wiring may result in breakdown of the product.
- Before connecting/disconnecting devices, make sure that the Sensor/Controller is turned OFF. The Sensor or Controller may break down if it is connected/disconnected while the power is ON.
- Use the extension cable sold separately for extending the cable between the Sensor (receiver) and the Controller.

 p.20

## 3. Warming Up

After turning the power supply ON, allow the product to stand for at least 10 minutes before use. The circuits are still unstable just after the power supply is turned ON, so measurement values may fluctuate gradually.

## 4. Maintenance and Inspection

Do not use thinner, benzene, acetone or kerosene to clean the Sensor and Controller. If large dust particles adhere to the filter on the front of the Sensor, use a blower brush (used to clean camera lenses) to blow them off. Do not use breath from your mouth to blow the dust off. To remove dust particles from the Sensor, wipe gently with a soft cloth (for cleaning lenses) moistened with a small amount of alcohol. Do not use excessive force to wipe off dust particles. Scratches to the filter might cause error.

## Editor's Note

### ■ Meaning of Symbols

Menu items that are displayed on the Controller's LCD screen, and windows, dialog boxes and other GUI elements displayed on the PC are indicated enclosed by brackets "[ ]".

### ■ Visual Aids

#### Important

Indicates points that are important to achieve the full product performance, such as operational precautions.

#### Note

Indicates application procedures.



Indicates pages where related information can be found.

MEMO

# CONTENTS

Operation Step Guide .....	16
----------------------------	----

## 1. BEFORE USE

<b>ZX-GT Series .....</b>	<b>20</b>
System Configuration .....	20
Part Names and Functions .....	21
<b>Mounting and Connecting Devices .....</b>	<b>25</b>
Mounting the Sensor .....	25
Mounting the Controller .....	27
Connecting Devices .....	28
Connecting Controllers to Each Other .....	37
Connecting Interface Units .....	38
<b>Initializing Controller Settings .....</b>	<b>39</b>

## 2. BASIC OPERATIONS

<b>Setting Measurement Conditions - FUN Mode .....</b>	<b>42</b>
Adjusting the Optical Axis and Registering the Standard Received Light Intensity .....	42
Selecting the Measurement Mode .....	44
<b>Setting Thresholds - T Mode .....</b>	<b>45</b>
<b>Functions and Operations during Operation</b>	
<b>- RUN Mode .....</b>	<b>46</b>
Switching the Measured Value Display .....	46
Executing and Canceling a Zero Reset .....	47

# 3.FUNCTION SETTINGS

<b>Settings Matched to Specific Measurement Requirements</b> .....	<b>50</b>
Specific Measurement Requirement and Measurement Mode Used .....	50
Explanation of Measurement Modes .....	52
<b>Adjusting Detection Conditions</b> .....	<b>61</b>
Measurement Cycle .....	61
Number of Samples to Average .....	62
Binary Level .....	63
Edge Filter .....	64
<b>Setting Output Conditions</b> .....	<b>65</b>
Judgment output timing (timer) .....	65
Hysteresis .....	67
Analog Output Conditions .....	68
<b>Setting Hold Functions</b> .....	<b>73</b>
Hold .....	73
Delay Hold .....	75
<b>Changing Display Conditions</b> .....	<b>77</b>
Reversing the Display .....	77
Changing the Number of Display Digits .....	78
Adjusting the Display Brightness (ECO mode) .....	79
<b>Setting Communication Conditions</b> .....	<b>80</b>
RS-232C Communications Specifications .....	80
Setting the Binary Output Cycle .....	81
<b>Special Functions</b> .....	<b>82</b>
Zero Reset Memory .....	82
Display during a Zero Reset .....	83
Key Lock .....	84
Switching Banks .....	85
Displaying the System Version .....	87

# 4.COMMUNICATIONS WITH EXTERNAL DEVICES

<b>Output Data List</b> .....	<b>90</b>
<b>Communications Using the Controller I/O Cable</b> ...	<b>91</b>
Using the Controller I/O Cable .....	91
<b>Binary Output</b> .....	<b>93</b>
Assignments and Functions of Output Signal Wires .....	93
Output Format .....	94
<b>I/O Timing Charts</b> .....	<b>95</b>
<b>RS-232C</b> .....	<b>100</b>
Communications on the RS-232C Interface .....	100
Connecting External Devices .....	101
About Communications Commands .....	102
Setting Acquisition/Change Commands .....	107
Measurement Control/Measured Value Acquisition Commands .....	123
Bank Control Command .....	127
Utility Command .....	128

# 5.APPENDICES

<b>Specifications and External Dimensions</b> .....	<b>130</b>
Sensor .....	130
Controller .....	133
Calculating Unit .....	135
Interface Unit .....	136
Extension Cable .....	138
<b>Error Messages and Corrective Actions</b> .....	<b>140</b>
Setup Errors .....	140
Measurement Errors .....	140
Standard Received Light Intensity Registration Errors ...	141
<b>Default Values</b> .....	<b>142</b>
<b>Basic Knowledge for Operation</b> .....	<b>143</b>

Reading Displays .....	143
List of Key Operations .....	143
<b>Laser Safety .....</b>	<b>144</b>
Label Replacement .....	144
<b>Requirements from Regulations and Standards .....</b>	<b>146</b>
Summary of Requirements to Manufactures .....	146
Summary of Requirements to User .....	150
Definitions of Laser Classification .....	153
<b>Compliance with EC Directives .....</b>	<b>154</b>
<b>Quick Reference for Displays .....</b>	<b>156</b>
<b>INDEX .....</b>	<b>161</b>
<b>Revision History .....</b>	<b>164</b>



MEMO

CONTENTS

# Operation Step Guide

## Basic Operation Procedure

### Mounting and Connections

Mounting the Sensor

 p.25

Mounting the Controller

 p.27

Connecting Devices

 p.28

### Preparations for Measurement (FUN)

Adjusting the Optical Axis and Registering the Standard Received Light Intensity

 p.42

Selecting the Measurement Mode

 p.44

### Setting Thresholds (T)

 p.45

### Start of Operation (RUN)

Zero Reset

 p.47

### Communications with External Devices

I/O Cable

 p.91

Binary Output

 p.93

RS-232C

 p.100

## To Improve Controller Performance

### ◆ Ignoring Rapid Changes in Measured Values

Adjusting the Number of Samples to Average  p.62

---

### ◆ Adjusting the Detection Sensitivity

Adjusting the Binary Level  p.63

---

Adjusting the Edge Filter  p.64

---

### ◆ Stabilizing Judgment Output

Changing/Adjusting the Timing of Judgment Outputs  p.65

---

Changing the Output Time  p.65

---

Adjusting Hysteresis  p.67

---

Setting the Delay Time  p.75

---

## (If required)

Returning Controller Settings to Their Defaults  p.39

---

Speeding the Measurement Cycle Up  p.61

---

Setting Hold Functions  p.73

---

Reversing the Controller Display  p.77

---

Changing the Number of Controller Display Digits  p.78

---

Operating in the ECO (power-saving) Mode  p.79

---

Holding the Zero Reset Value  p.82

---

Offsetting the Zero Reset Value  p.83

---

Key Lock Function  p.84

---

Switching Banks  p.85

---

MEMO

# BEFORE USE

---

<b>ZX-GT Series</b>	<b>20</b>
System Configuration	20
Part Names and Functions	21
<b>Mounting and Connecting Devices</b>	<b>25</b>
Mounting the Sensor	25
Mounting the Controller	27
Connecting Devices	28
Connecting Controllers to Each Other	37
Connecting Interface Units	38
<b>Initializing Controller Settings</b>	<b>39</b>

# ZX-GT Series

The ZX-GT Series Smart Sensors are a length measurement sensor using a CCD device. Position, dimensions, and other information can be stably measured by a line beam comprising a visible semiconductor laser and an optical scale on the CCD line sensor.

## System Configuration

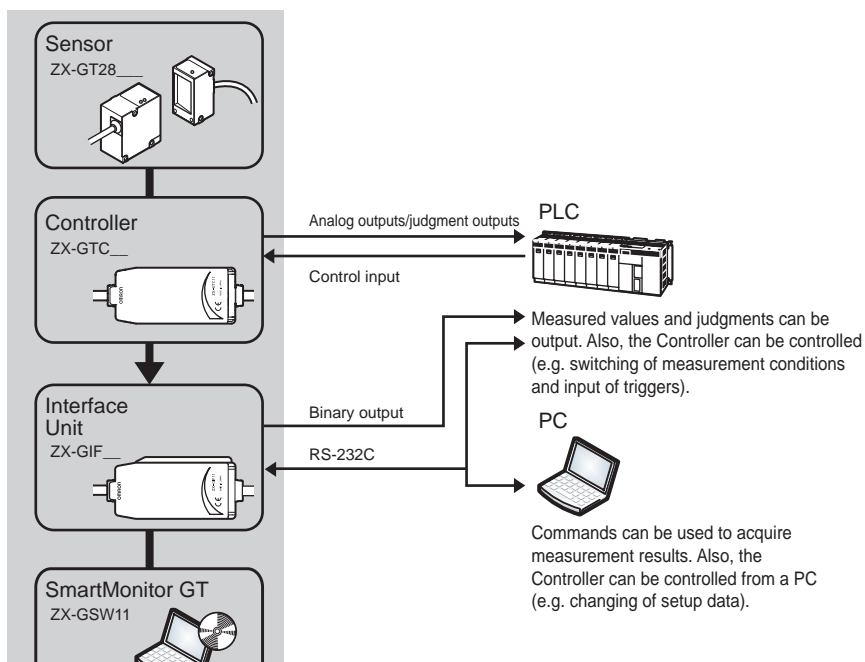

### Options

#### • Receiver-Controller Extension Cable

p.29

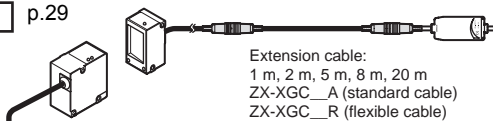

#### • Calculating Unit

ZX-CAL2



- Connecting Controllers to Each Other p.37
- Calculation of measurement results p.59

# Part Names and Functions

## Sensor

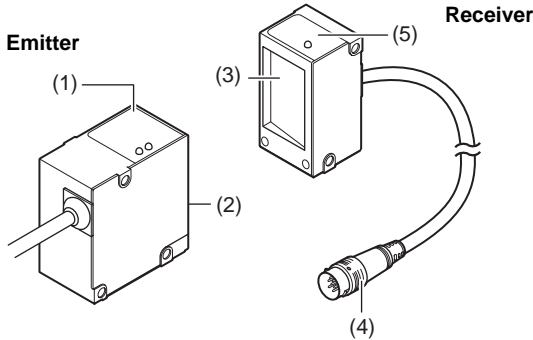



1 BEFORE USE

Name	Function								
(1) Laser indicators	<p>These are laser beam warning indicators. When the laser is being emitted, the "laser ON indicator (ON, green)" turns ON, and when the laser has deteriorated, the "laser deterioration alarm indicator (ALARM, red)" turns ON.</p> <div style="border: 1px solid black; padding: 5px; width: fit-content; margin: 10px auto;"> <table style="border-collapse: collapse;"> <tr> <td style="padding: 2px 5px;">ON</td> <td style="text-align: center; padding: 2px 5px;">○</td> <td style="padding: 2px 5px;">—</td> <td style="padding: 2px 5px;">Laser ON indicator</td> </tr> <tr> <td style="padding: 2px 5px;">ALARM</td> <td style="text-align: center; padding: 2px 5px;">○</td> <td style="padding: 2px 5px;">—</td> <td style="padding: 2px 5px;">Laser deterioration alarm indicator</td> </tr> </table> </div>	ON	○	—	Laser ON indicator	ALARM	○	—	Laser deterioration alarm indicator
ON	○	—	Laser ON indicator						
ALARM	○	—	Laser deterioration alarm indicator						
(2) Laser emitter	This emits the laser for measurement.								
(3) Laser receiver	This receives the laser light emitted from the laser emitter.								
(4) Connector	This is the connector for connecting to the Controller.								
(5) Optical axis setting indicator	<p>This indicator turns ON when the laser's optical axis is aligned in the optical axis adjustment mode.</p> <div style="margin-top: 10px;">  Optical axis mode p.42         </div>								

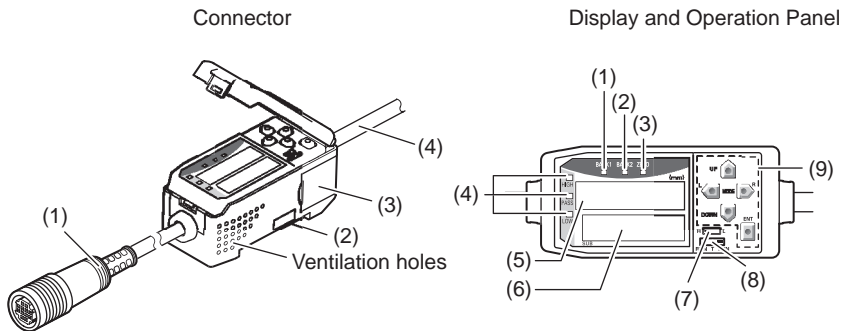
## Controller



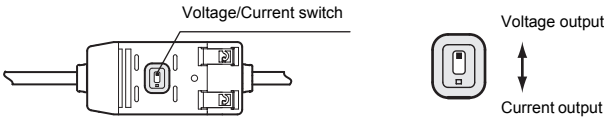

## Connectors

Name	Function
(1) Input cable	This is for connecting the Sensor receiver.
(2) Voltage/Current switch (on rear side)	<p>This switch is for selecting voltage output or current output as the analog output. (default value: voltage output)</p>  <p>Output scaling settings are also required when switching the output.</p> <p> p.68</p> <p><b>Important</b></p> <p>Before operating this switch, make sure that the Controller is turned OFF. Make sure that the load connected to "analog output wire (co-axial) - analog GND wire" satisfies the rating of the set state (voltage or current output) before turning the Controller ON. Otherwise, the Controller may be damaged.</p> <p> Rating of Connected Loads (I/O Circuit Diagrams) p.33</p>
(3) Controller connector	This connector is for connecting Calculating and Interface Units. (total 2 connectors, one on each side)
(4) Output cable	The output cable connects the Controller to the power supply and external devices, such as timing sensors or PLCs.



## Display and operation panel

Name	Function
(1) Bank 1 indicator	This indicator turns ON when bank 1 is selected.
(2) Bank 2 indicator	This indicator turns ON when bank 2 is selected.
(3) Zero reset indicator	This indicator turns ON when the zero reset function is enabled.
(4) Judgment output indicator	<p>HIGH LED : This indicator lights when "the HIGH threshold &lt; the measured value."</p> <p>PASS LED : This indicator lights when "the LOW threshold ≤ the measured value ≤ the HIGH threshold."</p> <p>LOW LED : This indicator lights when "the measured value &lt; the LOW threshold value."</p>
(5) Main display indicator	<p>The main display shows measured values and function names.</p> <p> Reading Displays p.143</p>
(6) Sub-display indicator	<p>The sub-display shows additional information and function settings for measurements.</p> <p> Reading Displays p.143</p>
(7) Threshold switch	The threshold switch selects whether to set (or display) the HIGH or LOW threshold.
(8) Mode switch	<p>The mode switch selects the operation mode.</p> <p>FUN : Select this mode when setting measurement conditions.</p> <p>T : Select this mode when setting thresholds.</p> <p>RUN : Select this mode when performing measurement.</p>
(9) Control keys	<p>Use the Control Keys to set the measurement conditions and switch the display.</p> <p> List of Key Operations p.143</p>

## Interface Unit

Connector

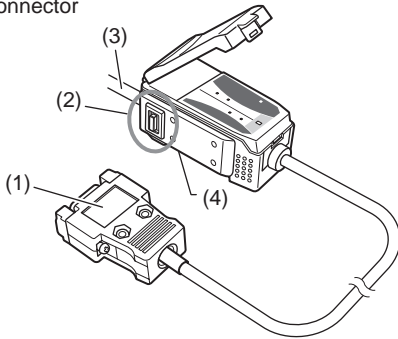

Display

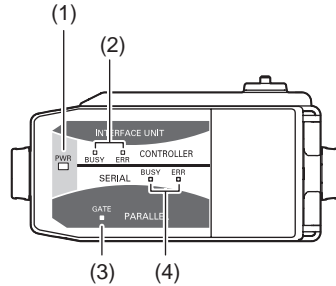

## Connector

Name	Function
(1) RS-232C connector	The RS-232C connector is for connecting the Controller to external devices, such as a PC or a PLC.
(2) Controller connector	This connector is for connecting the ZX-GTC Controllers.
(3) Binary output cable	This cable connects external devices such as a PLC so that measurement data is output in binary.
(4) Rear switch	This switch is not used during measurement. Be sure to leave this switch at its default setting (position in figure below). If this switch setting is changed, the communications functions will be changed and the Controller will not operate correctly.

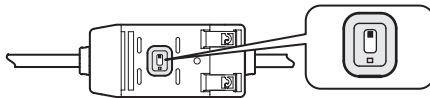

## Display

Name	Function
(1) Power ON indicator	The power ON indicator lights while the power is ON.
(2) Controller communications indicator	BUSY: This indicator lights when communications commands are being issued to the Controller. ERR : This indicator lights if an error occurs during communications with the Controller.
(3) Binary output indicator	This indicator lights during binary output.
(4) RS-232C communications indicator	BUSY: This indicator lights when RS-232C communications is in progress. ERR : This indicator lights if an error occurs during RS-232C communications.

# Mounting and Connecting Devices

## Mounting the Sensor

### ⚠ CAUTION

Never look into the laser beam. Doing so continuously will result in visual impairment.



Do not attempt to dismantle, pressurize, or incinerate the product. Doing so may cause the laser beam to leak, resulting in the danger of visual impairment.



1 BEFORE USE

### Important

If a measurement target has a shiny surface, reflected light might adversely influence adjacent Sensors. Mount the Sensor so that it is not influenced by reflected light.

#### Example: XY cross measurement

Place the Sensors so that their optical axes do not overlap each other.

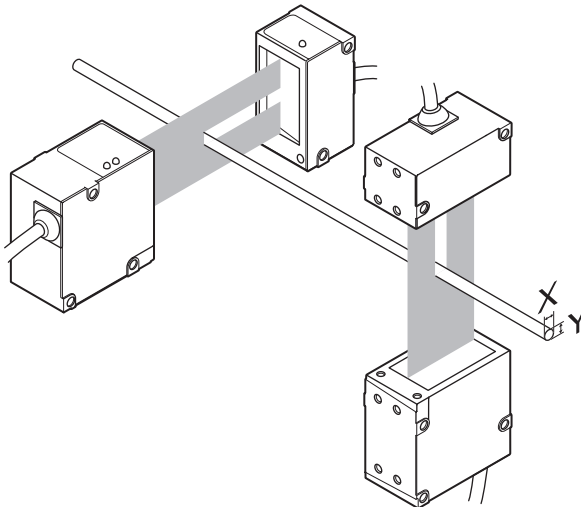

## Separate Type (Emitter and Receiver)

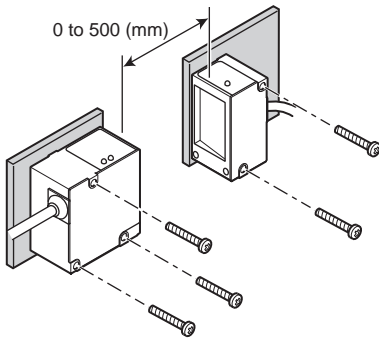

Fix the Sensor onto the mounting base with M4 screws.

Tightening torque: 1.2 N•m

### Important

For details on the positions of screw holes, check the external dimensions in "5 APPENDICES."



- External dimensions p.131
- Adjusting the Optical Axis p.42

## Integrated Type

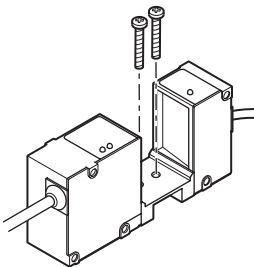

Fix the Sensor onto the mounting base with M3 screws.

Tightening torque: 0.5 N•m

### Important

For details on the positions of screw holes, check the external dimensions in "5 APPENDICES."



- External dimensions p.132

# Mounting the Controller

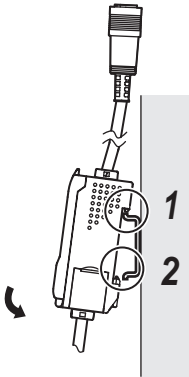

- 1 Hook the connector end of the Controller onto the DIN track.

### Important

Always hook the connector end of the Controller onto the DIN track first. Mounting strength may decrease if the I/O cable end is hooked onto the DIN track first.

- 2 Push the Controller down onto the DIN track until the hook on the I/O cable side is locked.

### Important

After mounting the Controller on the DIN track, attach the end plates (sold separately) on both sides of the Controller.

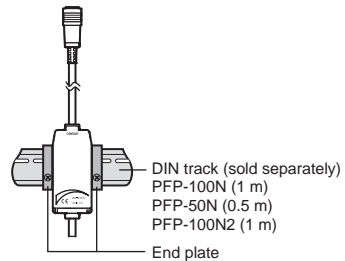

## Removal

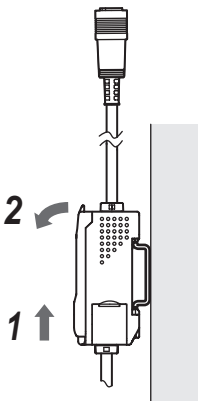

- 1 Push the Controller up towards the connector side.
- 2 Lift up the Controller from the connector end, and remove it from the DIN track.

# Connecting Devices

## Connecting Devices in the Basic Configuration

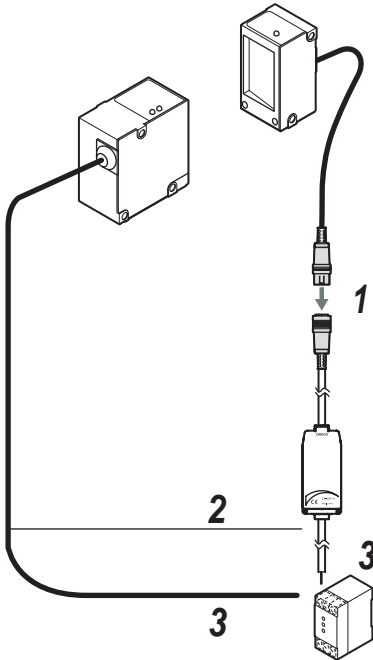

### Important

Before connecting/disconnecting the Sensor, make sure that the Controller is turned OFF. The Controller may break down if the Sensor is connected or disconnected while the power is ON.

- 1** Insert the receiver connector into the Controller connector.
- 2** Connect the Controller and Sensor sync wires.  
Controller sync output wire : yellow  
Emitter sync input wire : red

### Important

The Controller's default mode is the standard mode. Measurement is not possible without the sync wires connected.

- 3** Connect the power wire (brown) and the GND wire (blue) of the emitter and the Controller I/O cable.

### Note

The following power supply is recommended:

- S8VS-03024 (24 VDC, 1.3 A)

### Note

When the measurement cycle has been changed to the high-speed mode (FAST), wiring of the sync wires is not required. Note, however, that the Controller becomes more susceptible to the influence of ambient light in this case.

### Important

Do not mount the Controller in such a way that a load is steadily applied on the connector, for example, with tension applied to the cables.

## To extend the connection between the receiver and the Controller

The cable connection between the receiver and the Controller can be extended by up to 30 meters using the extension cable (sold separately). The emitter side can be extended by up to 30 meters by connecting via the terminal block, for example.

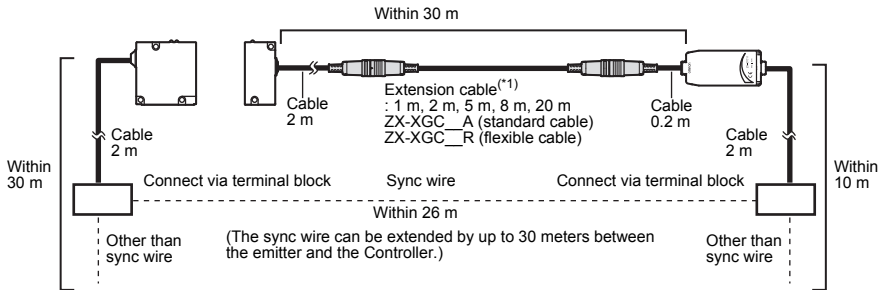

\*1: Up to two extension cables can be connected. However, be sure to limit the total extension cable length between the receiver and the Controller to 30 meters (including the receiver cable).

1 BEFORE USE

## Wiring the Sensor (emitter)

### Wiring diagram



### Names and functions

Cable color	Name	Function
Brown	Power supply (24 VDC)	This is the power supply terminal. Connect the 24 VDC power supply to this terminal. When using a PNP type Controller, the power supply terminal is also the common terminal for all I/O.
Blue	GND (0V)	This is the power supply 0 V terminal. When using an NPN type Controller, the power supply terminal is also the common terminal for all I/O.
Orange	Laser deterioration alarm output	This output turns ON when the semiconductor laser deteriorates. Replace the Sensor when this output turns ON.
Red	Laser OFF input/sync input	Laser emission stops when this output turns ON. Synchronized operation is available with this wire connected to the Controller's sync output, and the influence of ambient light can be reduced. Laser output can also be turned OFF with this input short-circuited to 0 V (24 V in the case of a PNP type Controller) in this connection state.

## Wiring the Controller

### Wiring diagram

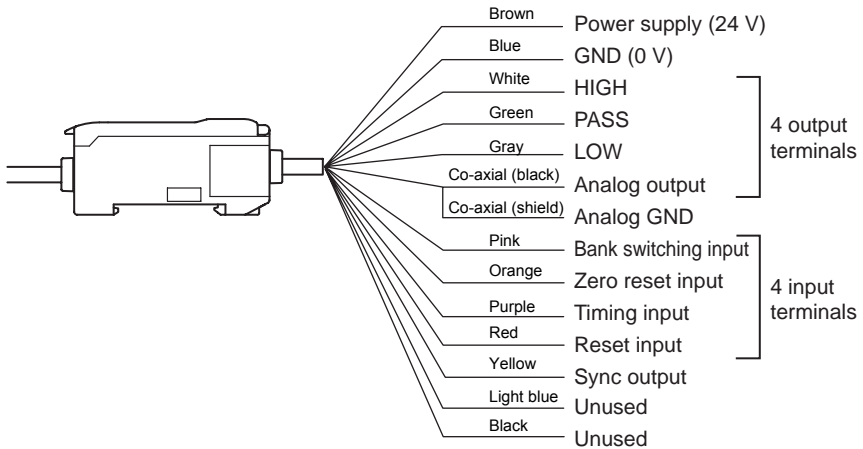

#### Important

- Use a stabilized power supply separate from other devices and power systems for the Controller, particularly when high resolution is required.



Recommended power supply p.28

- Wire the Controller correctly. Otherwise, the Controller may be damaged. (Pay particular attention to prevent contact between the analog output and other wires.)
- Use the shield wire for the analog output. Do not use it in the same way as the blue wire (GND) for the power supply.
- Always connect the blue wire (GND) even when the analog output is not used.



## Names and Functions

Cable color	Name	Function
Brown	Power supply (24 V)	This is the power supply terminal. Connect the 24 VDC power supply to this terminal. When using a PNP type Controller, the power supply terminal is also the common terminal for all I/O excluding analog output.
Blue	GND (0 V)	This is the power supply 0 V terminal. When using an NPN type Controller, this terminal is also the common terminal for all I/O excluding analog output.
Co-axial (shield)	Analog GND	Connect this cable to the input device as the GND for analog output.
Yellow	Sync output	Normally, wire this cable directly to the sync input wire and run the Controller in the standard mode (NORM). When the Controller is run in the high-speed mode (FAST), operation is possible without wiring this cable. (Note that, in the high-speed mode, the Controller becomes more susceptible to the influence of ambient light than in the standard mode.)



Assignments and Functions of I/O Signal Wires p.91

## Wiring the Interface Unit Output Cables

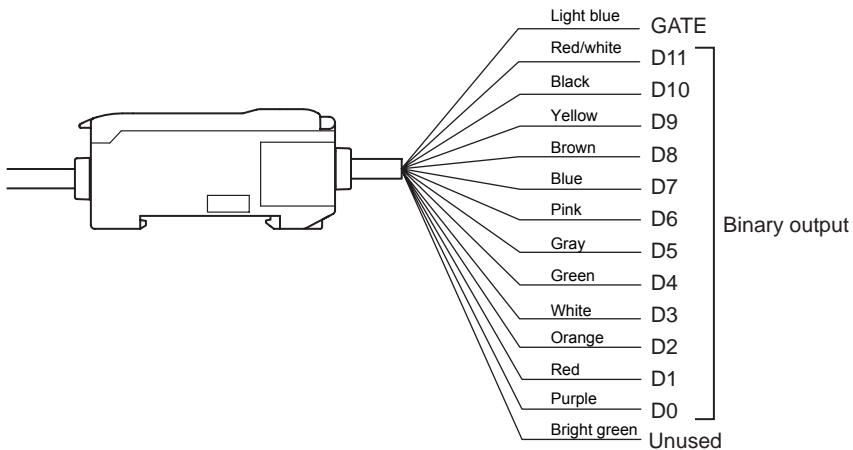

Assignments and Functions of Output Signal Wires p.93

## Sensor (emitter) I/O Circuit Diagrams

### NPN type Controller (ZX-GT28E11)

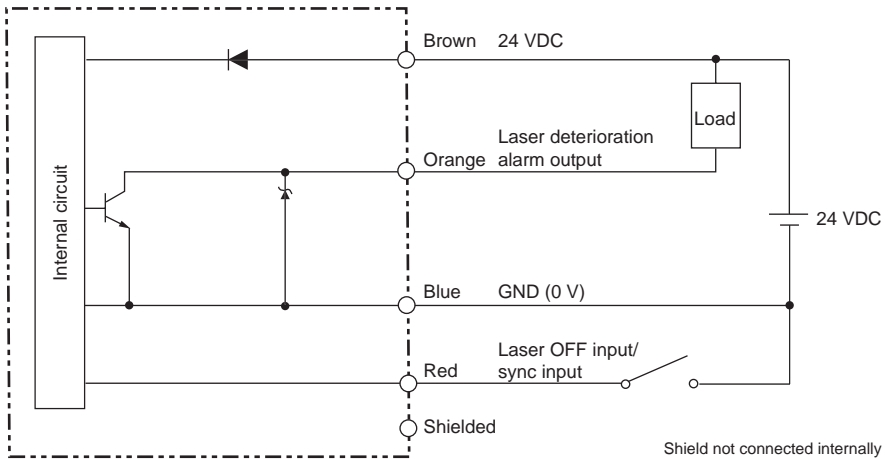

### PNP type Controller (ZX-GT28E41)

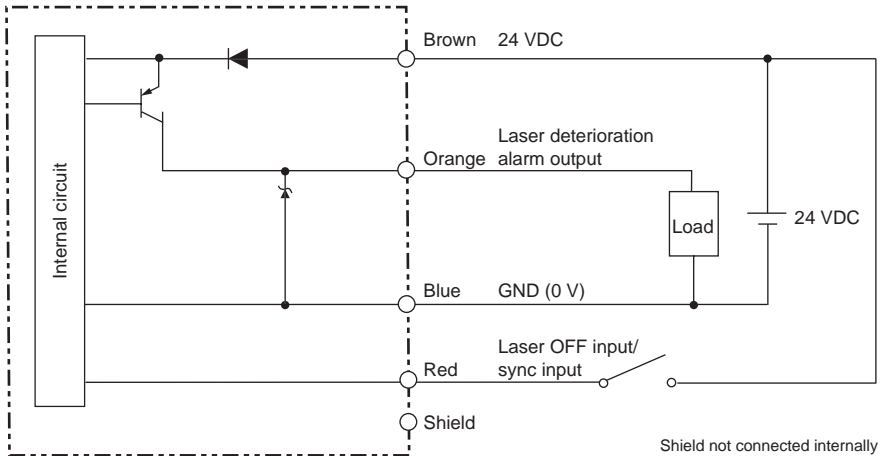

# Controller I/O Circuit Diagrams

## Important

Make sure that the load connected to "analog output wire (co-axial) - analog GND wire" satisfies the rating of the set state (voltage or current output) before turning the Controller ON. Otherwise, the Controller may be damaged.

### NPN type Controller (ZX-GTC11)

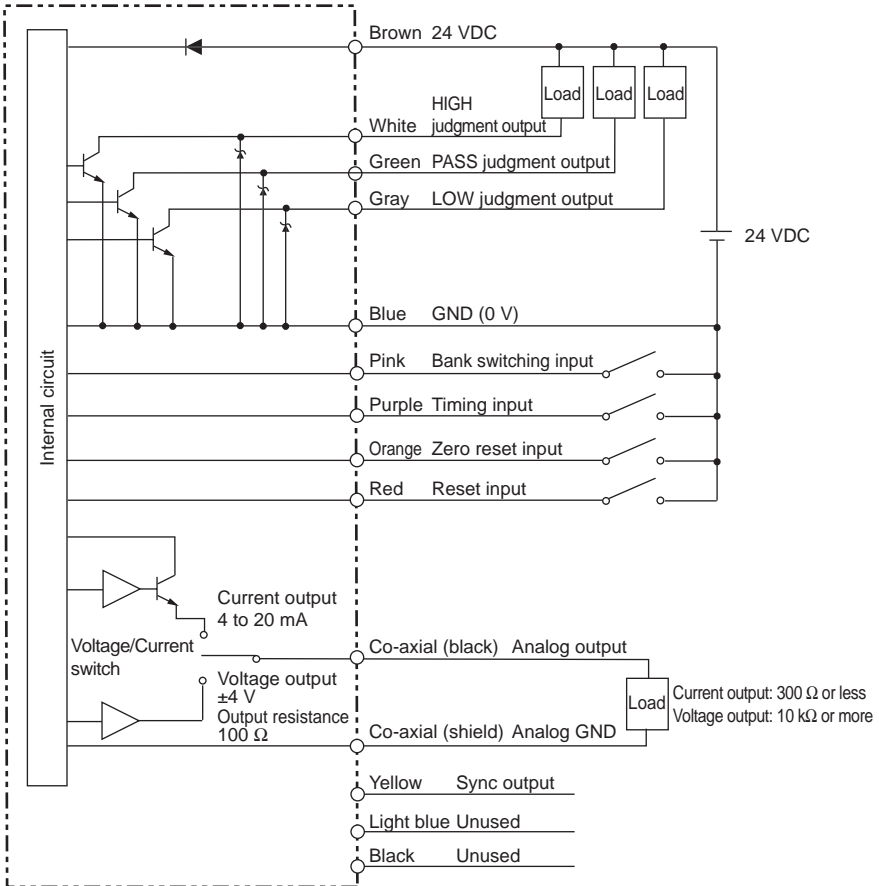

1 BEFORE USE

# PNP type Controller (ZX-GTC41)

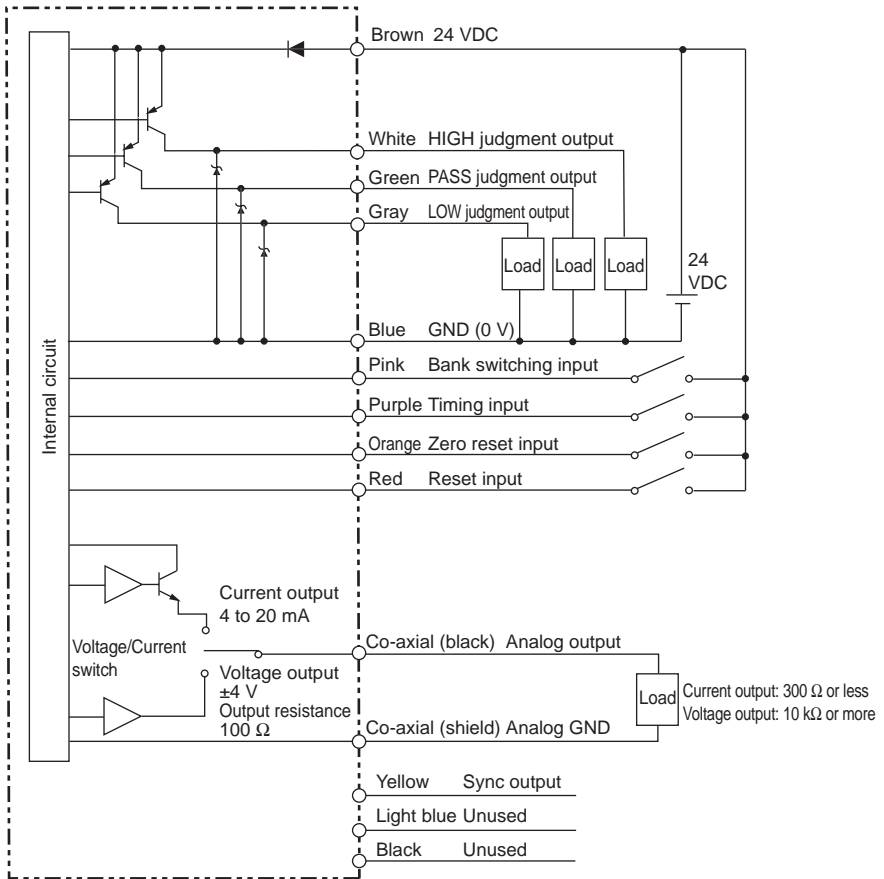

## Interface Unit I/O Circuit Diagrams

The following circuit configurations are used for data outputs (D0 to D11) and the total of 13 GATE signal outputs.

### NPN type

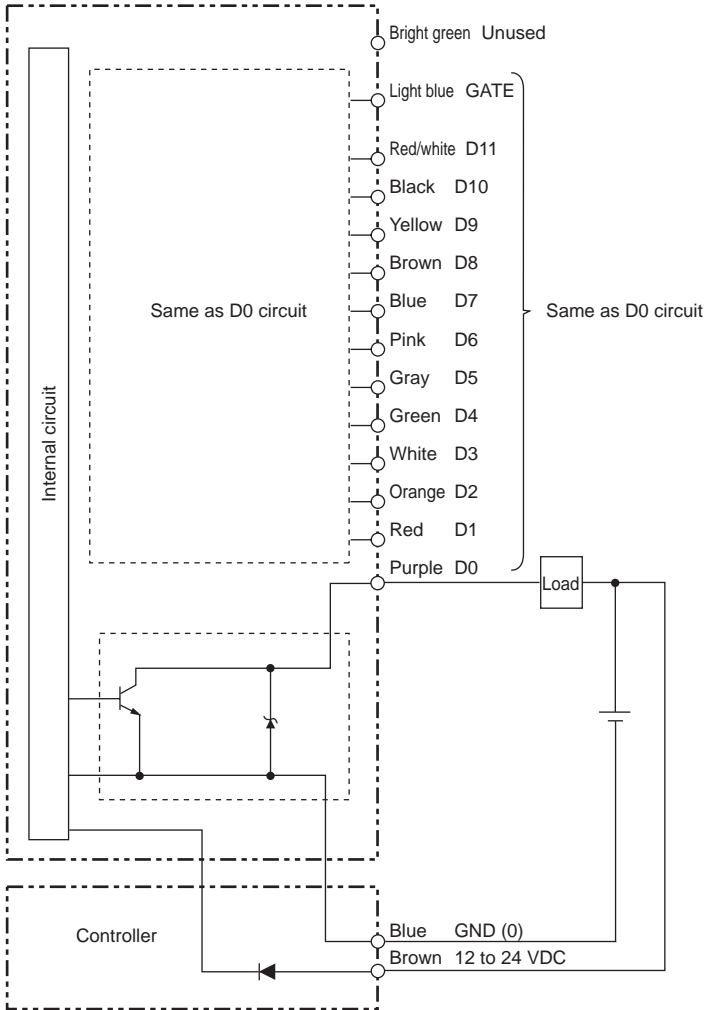

1 BEFORE USE

# PNP type

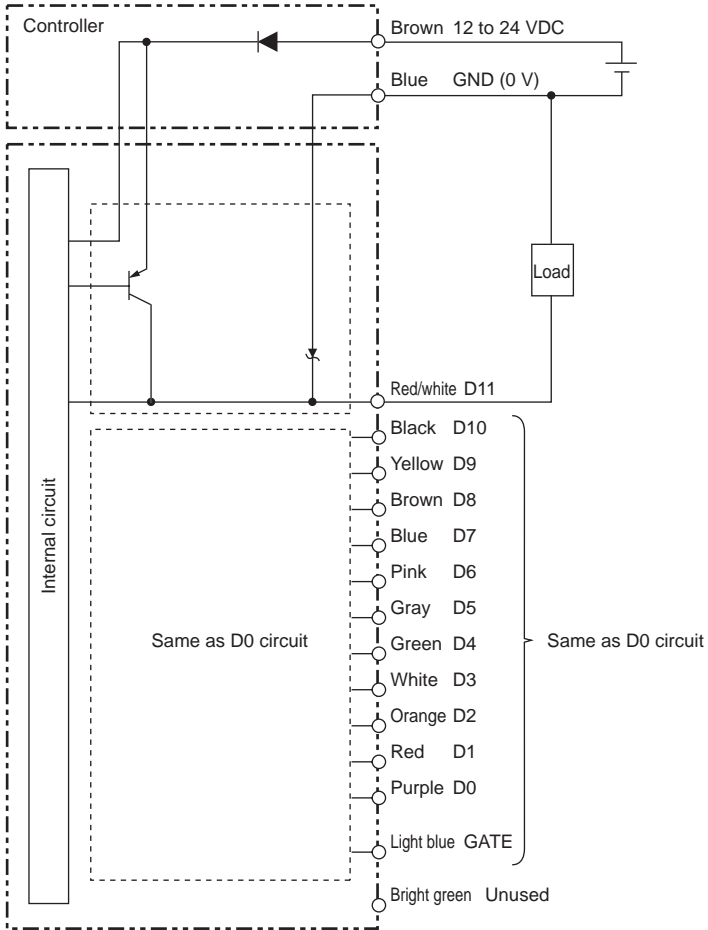

# Connecting Controllers to Each Other

Controllers are connected to each other via a Calculating Unit.

The number of Controllers that can be connected to each other is as follows:

- When calculating Controller measured values: three Controllers

Calculation can be performed on two of these Controllers. (One of the calculation targets must always be CH1.)

- When multiple points are measured and are collectively output from the Interface Unit: three Controllers or less

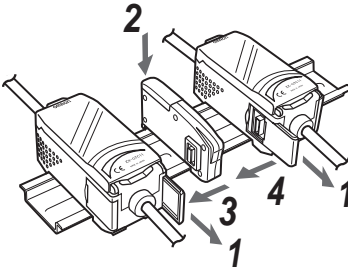

- 1** Open the Controller connector cover by lifting and sliding it up.
- 2** Mount the Calculating Unit on a DIN track.
- 3** Slide the Calculating Unit and insert it into the connector on the Controller.
- 4** Slide the Controller to insert it into the connector on the Calculating Unit.

## Important

- Provide power to all connected Controllers.
- Connect the emitter sync wires to the respective Controllers.



- Wiring the Sensor (emitter) p.29
- Wiring the Controller p.30

# Connecting Interface Units

When outputting measurement data in binary or performing RS-232C communications, attach the Interface Unit (sold separately).

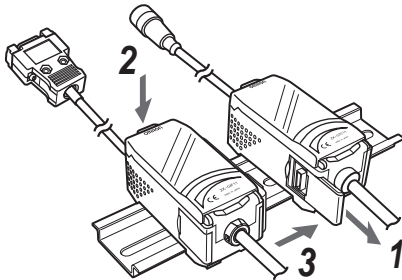

- 1** Open the Controller connector cover by lifting and sliding it up.
- 2** Mount the Interface Unit on a DIN track.
- 3** Slide the Interface Unit to insert it into the connector on the Controller.

## Note

### Channels Nos. when Controllers are connected to each other

The channel Nos. when Controllers are connected to each other are arranged as follows from the right "CH1, CH2, CH3".

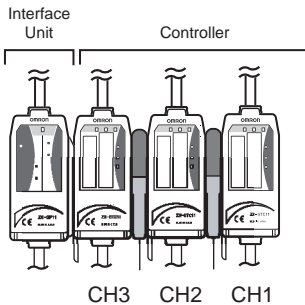

## Note

### Cable clamp provided with the Controller

The RS-232C cable can be fixed to devices, for example, using the cable clamp supplied with the Controller.

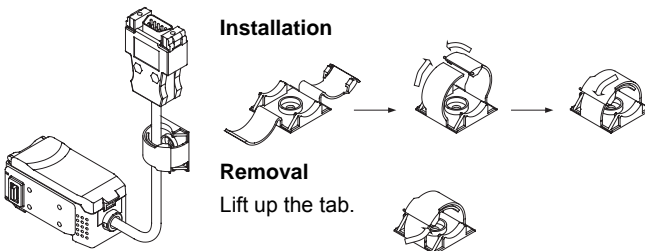



# Initializing Controller Settings



## Important

The settings of all banks and system settings are initialized regardless of the currently selected bank No. To save these settings, back them up to a personal computer using the SmartMonitor GT (ZX-GSW11) before performing initialization.

 Default States p.142



## 1 Initialize Controller settings.

-  /  Select [INIT].
-  Hold down to confirm the selection.



During initialization of the Controller settings, "-----" is displayed one digit at a time.



When initialization is completed, [OK] is displayed.

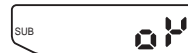

MEMO

# BASIC OPERATIONS

---

<b>Setting Measurement Conditions - FUN Mode</b>	<b>42</b>
Adjusting the Optical Axis and Registering the Standard Received Light Intensity	42
Selecting the Measurement Mode	44
<b>Setting Thresholds - T Mode</b>	<b>45</b>
<b>Functions and Operations during Operation - RUN Mode</b>	<b>46</b>
Switching the Measured Value Display	46
Executing and Canceling a Zero Reset	47

# Setting Measurement Conditions - FUN Mode

## Adjusting the Optical Axis and Registering the Standard Received Light Intensity

When using an integrated Sensor, adjustment of the optical axis in step 3 is not required.

### Important

Connect the Controller and Sensor sync wires.

- Wiring the Sensor (emitter) p.29
- Wiring the Controller p.30



RUN T FUN

### 1 Switch to the optical axis adjustment mode.

/ Select [ALIGN].

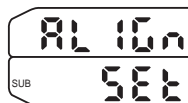

### 2 Switch to the received light balance display to show received light balance and light intensity.

Confirm the selection.

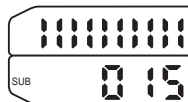

### 3 Adjust the emitter while verifying the light intensity.

- Adjusting the received light intensity while viewing the receiver

Move the emitter in the four directions (left, right, top and bottom) to adjust the received light intensity until the optical axis setting indicator (green) on the receiver lights.

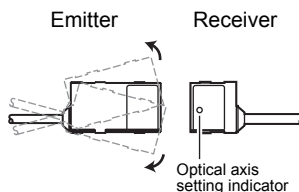

- Adjusting the received light intensity while viewing the Controller

(1) Received light intensity

The received light intensity is displayed as a numerical value.

Standard mode (NORM): about 70 or more

High-speed mode (FAST): about 100 or more

Move the emitter to the left and right to adjust the received light intensity until the display indicates the above values.

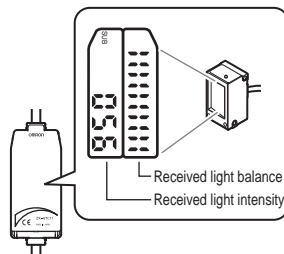

(2) Received light balance

The received light balance of the CCD is displayed.

- When one of the sides of the display is missing

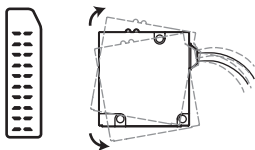

Move the emitter in the direction in which the display is missing to adjust.

- When both sides of the display are missing

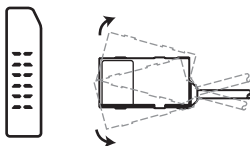

- Insufficient received light intensity?  
Move the emitter to the left and right to increase the received light intensity.
- Sync output wired?  
Wire the Controller sync output and Sensor sync input.

- When the center of the display is missing

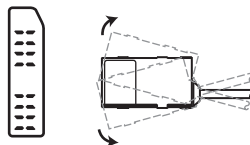

- Insufficient received light intensity?  
Move the emitter to the left and right to increase the received light intensity.
- Dirty emitter surface or object blocking light path?  
Clean the emitter surface or remove object blocking light path.

**Note**

The received light waveform can be observed in more detail on the exclusive PC software (SmartMonitor GT (ZX-GSW11)).

## 4 Register the standard received light intensity.

- Hold down for at least three seconds.

When registration of the standard received light intensity ends normally, [OK] is displayed on the sub-display after "----".

When registration of the standard received light intensity fails, an error is displayed.

Standard Received Light Intensity Registration Errors p.141

# Selecting the Measurement Mode

Select the measurement mode matched to your specific measurement requirements from the FUN mode menu.





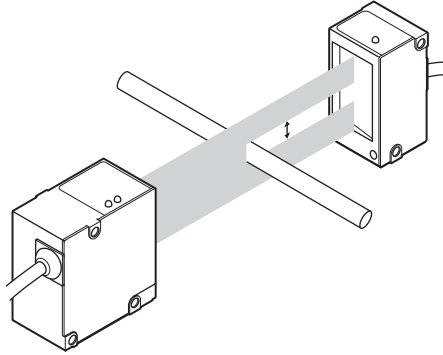

Specific Measurement Requirement and Measurement Mode Used p.50

The following describes, as an example, the basic operation procedure for measuring the outer diameter.



RUN T FUN

## 1 Select the measurement mode.

-  /  Select [MODE].
-  /  Select [DIA].
-  Confirm the selection.



# Setting Thresholds - T Mode

In this mode, set the measured values for a PASS (OK) judgment. Both HIGH and LOW threshold values are set. Three judgment results are output; "HIGH", "PASS" and "LOW".

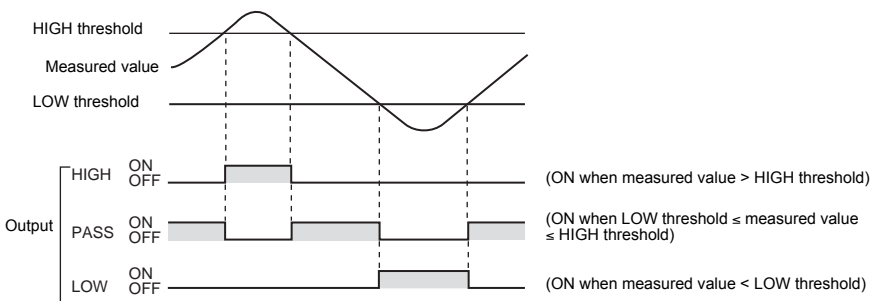

**Note**

In the special mode (IC lead pitch or IC lead width judgment mode), the following values are output:

HIGH: Standard value setting

LOW: Tolerance setting

Measurement Cycle p.61

The following describes, as an example, the operation procedure for setting a HIGH threshold.



**1 Set the value.**

- / Move from one digit to another.
- / Change the current value.
- Confirm the selection.



**Note**

Hysteresis can also be set for threshold values. Set hysteresis when judgments are unstable.

Hysteresis p.67

## Switching the Measured Value Display

You can switch between the main display and sub-display while operating the Controller in the RUN mode. This allows you to verify thresholds, resolution and other settings while viewing measured values according to your specific application.

The measured value is displayed on the main display, and thresholds and other information are displayed on the sub-display.

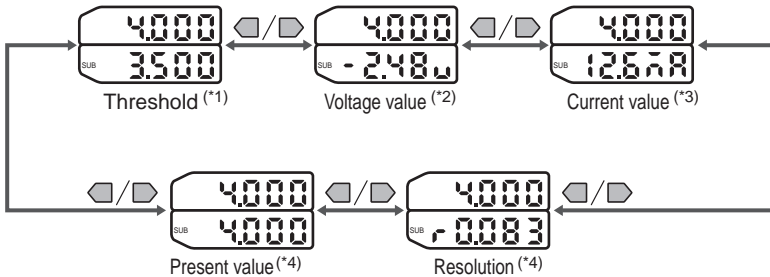

\*1: In the IC lead pitch and IC lead width judgment modes, standard values and tolerances are displayed according to the threshold switch setting.

\*2: In the IC lead pitch and IC lead width judgment modes, "0V" is displayed at all times.

\*3: In the IC lead pitch and IC lead width judgment modes, "4mA" is displayed at all times.

\*4: In the IC lead pitch and IC lead width judgment modes, "-----" is displayed at all times.

 Special mode p.50



# Executing and Canceling a Zero Reset

When the zero reset function is used, the measured value can be reset to a reference value of 0 when the ENT key is pressed or an external signal is input.

The analog output shifts to the minimum measurement value (4 mA or -5 V) when a zero reset is performed. If output scaling is set, the shift is to the scaled minimum value. If an offset value is set for the zero reset, the output is set to the output value that corresponds to the display value.

 Executing/Canceling a Zero Reset by External Signal Input p.126

When the Controller is turned OFF, all settings are cleared from memory (i.e. are returned to their defaults). This setting can also be changed so that settings are saved in memory when the power is turned OFF.

 Zero Reset Memory p.82

## Executing zero reset



RUN T FUN

**1** Set the measurement object to be used as the reference in place.

**2** Execute the zero reset.

 Hold down for at least one second.

The zero reset indicator lights, and the current measured value is registered as "0" (zero).



### Note

A value other than 0 can also be set.

 Zero Reset Memory p.82

## Canceling zero reset



RUN T FUN

### 1 Cancel the zero reset.



Hold down the R key for at least three seconds with the ENT key held down.

The zero reset indicator goes out.













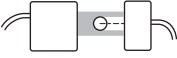

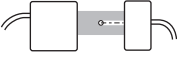





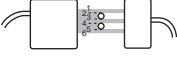

# FUNCTION SETTINGS

<b>Settings Matched to Specific Measurement Requirements</b>	<b>50</b>
Specific Measurement Requirement and Measurement Mode Used	50
Explanation of Measurement Modes	52
<b>Adjusting Detection Conditions</b>	<b>61</b>
Measurement Cycle	61
Number of Samples to Average	62
Binary Level	63
Edge Filter	64
<b>Setting Output Conditions</b>	<b>65</b>
Judgment output timing (timer)	65
Hysteresis	67
Analog Output Conditions	68
<b>Setting Hold Functions</b>	<b>73</b>
Hold	73
Delay Hold	75
<b>Changing Display Conditions</b>	<b>77</b>
Reversing the Display	77
Changing the Number of Display Digits	78
Adjusting the Display Brightness (ECO mode)	79
<b>Setting Communication Conditions</b>	<b>80</b>
RS-232C Communications Specifications	80
Setting the Binary Output Cycle	81
<b>Special Functions</b>	<b>82</b>
Zero Reset Memory	82
Display during a Zero Reset	83
Key Lock	84
Switching Banks	85
Displaying the System Version	87

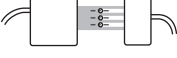
# Settings Matched to Specific Measurement Requirements

## Specific Measurement Requirement and Measurement Mode Used

			Mode Used
Position	Edge position	Regular positioning 	Interrupted beam width measurement mode 
			Incident beam width measurement mode 
	Center position	Position of round bar 	Center position measurement mode 
	Thin wire position	Position of wire 	Wire position measurement mode 
Dimension	Outer diameter dimension	Round bar diameter 	Outer diameter measurement mode 
	Gap	Internal diameter measurement 	Incident beam width measurement mode 
	Specified edge measurement	Can be freely specified. 	Specified edge measurement mode 
	Thick diameter	Measuring between 2 sensors 	Calculation of measurement results 
Special	Glass edge position		Glass edge measurement mode 
	IC lead pitch		IC lead pitch judgment mode 
	IC lead width		IC lead width judgment mode 

Explanation	Reference
The width up to the end of the first interrupted beam section is measured.	p.52
The width up to the end of the first incident beam section is measured.	p.52
The width from the top edge of the beam up to the center of the first and last edges of the measurement object is measured.	p.58
Thin wire of up to 0.1 mm in diameter is measured. Measurement details are the same as those for the "center position measurement mode."	p.53
The width from the first edge of the measurement object up to the last edge is measured.	p.58
The width up to the end of the first incident beam section is measured.	p.53
The width between two specified edges is measured.	p.52
The interrupted beam width of two Sensors is calculated to measure the diameter.	p.56
The edge position of glass sheets is measured. In this mode, the distance from the beam top edge to the edge of the transparent material is measured.	p.59
The distance between IC lead centers is measured, and whether or not the pitch is within the tolerance is judged.	p.54
The IC lead width (multiple IC leads OK) is measured, and whether or not the diameter is within the tolerance is judged.	p.55

# Explanation of Measurement Modes

## Interrupted Beam Width Measurement Mode [DK.WID]

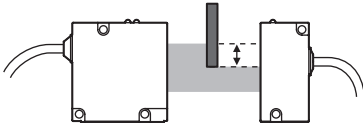

This mode is for measuring the width up to the end of the first interrupted beam section.

 How to select the measurement mode p.44

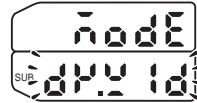

### Note

In cases such as the following, the width of the first interrupted beam section is measured from the side of the Sensor where the LED is located.

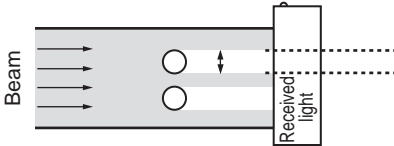

This width is measured.

## Incident Beam Width Measurement Mode [LT.WID]

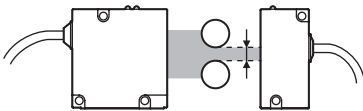

This mode is for measuring the width up to the end of the first incident beam section.

 How to select the measurement mode p.44

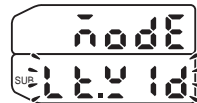

### Note

In cases such as the following, the width of the first incident beam section is measured from the side of the Sensor where the LED is located.

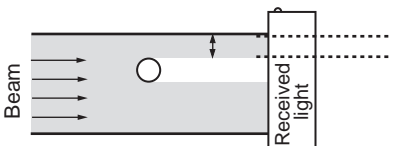

This width is measured.

## Outer Diameter Measurement Mode [DIA]

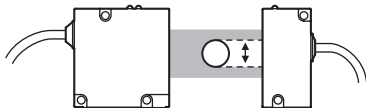

This mode is for measuring the width from the first edge of the measurement object up to the last edge.

 How to select the measurement mode p.44

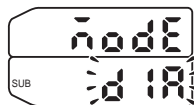

### Note

In cases such as the following, the width from the first edge up to the last edge is measured from the side of the Sensor where the LED is located.

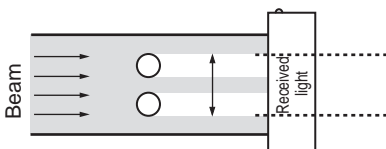

This width is measured.

## Center Position Measurement Mode [POSN]

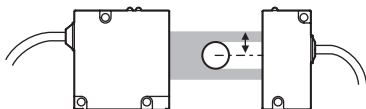

This mode is for measuring the width from the top edge of the beam up to the center of the measurement object.

 How to select the measurement mode p.44

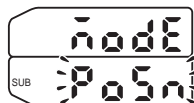

### Note

In cases such as the following, the width from the first edge up to the center of the first and last edges is measured from the side of the Sensor where the LED is located.

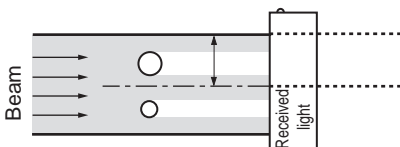

This width is measured.

## IC Lead Pitch Judgment Mode [PIN-P]

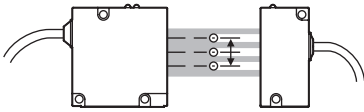

This mode is for measuring the pitch between IC leads, and for judging whether the pitch is within the tolerance.

How to select the measurement mode p.44



	Description	Range
Number of IC leads (A)	Set the number of IC leads of the measurement object.	2 to 14 (IC leads)
IC lead pitch (B)	Set the IC lead pitch to be used as the standard.	0.6 to 28 (mm)
IC lead pitch tolerance	Set the tolerance of the measured value with respect to the reference value.	0 to 28 (mm)

After selecting the measurement mode, make the following settings.

### 1 Set the number of IC leads.

- / Change the selection.
- Confirm the selection.



### 2 Set the IC lead pitch to be used as the standard.

- / The sub-display flashes.
- / Move from one digit to another.
- / Change the current value.
- Confirm the selection.



### 3 Set the IC lead pitch tolerance.

- / The sub-display flashes.
- / Move from one digit to another.
- / Change the current value.
- Confirm the selection.

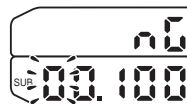



## IC Lead Width Judgment Mode [PIN-D]

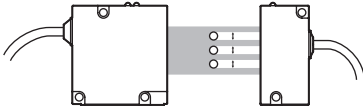

This mode is for measuring the width of multiple IC leads, and for judging whether the diameter is within the tolerance.

How to select the measurement mode p.44

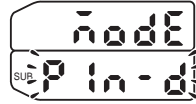

	Description	Range
Number of IC leads (A)	Set the number of IC leads of the measurement object.	1 to 14 (IC leads)
IC lead width (B)	Set the IC lead width to be used as the standard.	0.3 to 28 (mm)
IC lead width tolerance	Set the tolerance of the measured value with respect to the reference value.	0 to 28 (mm)

After selecting the measurement mode, make the following settings.

### 1 Set the number of IC leads.

- / Change the selection.
- Confirm the selection.



### 2 Set the IC lead width to be used as the standard.

- / The sub-display flashes.
- / Move from one digit to another.
- / Change the current value.
- Confirm the selection.



### 3 Set the IC lead width tolerance value.

- / The sub-display flashes.
- / Move from one digit to another.
- / Change the current value.
- Confirm the selection.

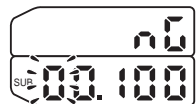

## Specified Edge Measurement Mode [EDGE]

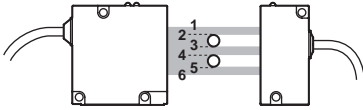

This mode is for measuring the width between two specified edges.



How to select the measurement mode p.44



	Description	Range
Edge No.	Set the edge of the measurement target.	1 to 30, 49, 50 For details, see "How to count edge Nos." p.57

After selecting the measurement mode, make the following settings.

### 1 Set the 1st edge.

- / Change the selection.
- Confirm the selection.



### 2 Set the 2nd edge.

- / Change the selection.
- Confirm the selection.



**Note****How to count edge Nos.****General measurement**

Edge Nos. are assigned from 1 to 30.

In the specified edge measurement mode, the top edge of the beam is always 1, and the bottom edge is always the last edge.

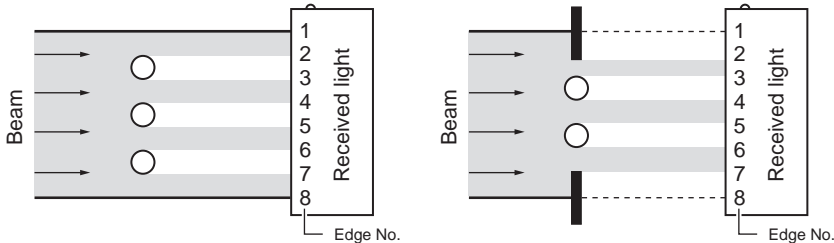
**Special measurement**

How the edge No. is counted differs according to measurement of (a) to (c) in the figure below.

- (a) Width from top edge of beam to last interrupted beam section (distance from edge 1 to 50)
- (b) Width from first interrupted beam section to last interrupted beam section (distance from edge 2 to 50)
- (c) Width of last interrupted beam section (distance from edge 49 to 50)

Though edge Nos. are generally assigned within the range 1 to 30, 49 is set when setting the top edge of the last interrupted beam section, and 50 is set when setting the bottom edge of the last interrupted beam section.

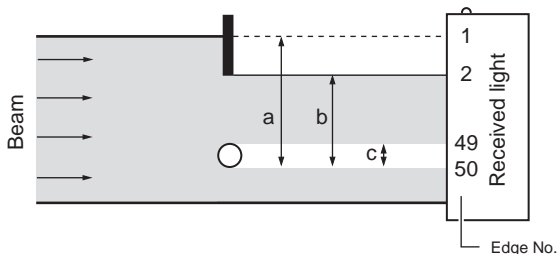
**Important**

- Set different edges for the 1st and 2nd edges.
- The 1st and 2nd edges can also be set and measured in the reverse order. Note, however, that the following restrictions apply:
  - The same edge No. cannot be set twice.
  - When "49" is set to one edge, be sure to set "50" to the other edge.
  - When "50" is set to one edge, be sure to set "1", "2" or "49" to the other edge.

## Wire Position Measurement Mode [THIN]

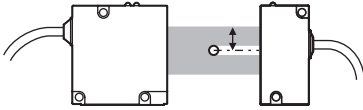

This mode is for measuring thin wire of up to 0.1 mm in diameter. Measurement details are the same as those for the "center position measurement mode."

 How to select the measurement mode p.44

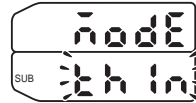

## Glass Edge Measurement Mode [GLASS]

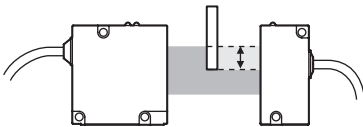

This mode is for measuring the edge position of glass sheets. In this mode, the distance from the beam top edge to the edge of the glass sheets is measured.

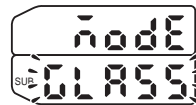

 How to select the measurement mode p.44

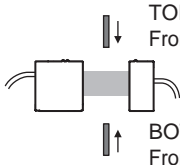

Setting value	Description
TOP	Set from which direction the measurement object will be inserted.
BOTTM	 <p>TOP (default value) From side of Sensor on which LED indicator is located</p> <p>BOTTOM From side of Sensor on which LED indicator is not located</p>

After selecting the measurement mode, make the following settings.

### 1 Set the edge detection direction.

-  /  Change the selection.
-  Confirm the selection.



## Calculating the Measurement Result [CALC]

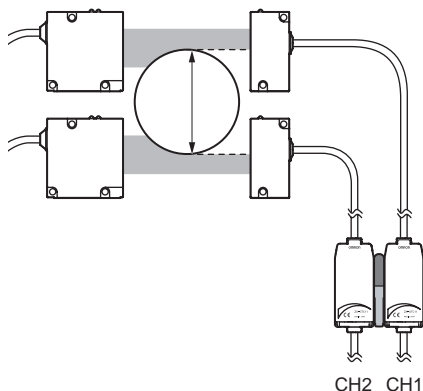

Measurement results can be calculated between two Controllers. Set the expression on the Controller having the larger CH No. The calculation result also is output from the Controller having the larger CH No.

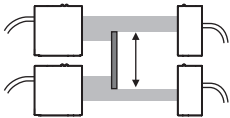
Setting value	Description
OFF	The measurement result is not calculated. (default value)
A+B	Calculates the sum of the measurement results for two Controllers.
A-B	Calculates the difference between the measurement results for two Controllers.
WIDTH	<p>Measures the width of a large measurement object exceeding 28 mm.</p>  <p>After selecting this value, set a measurement target of known width to the measured state and enter the width. Range: 0.00 to 599.99 (mm)</p>

### Important

When [WIDTH] is set, the range of the measured value becomes 0.00 to 599.99 mm.

### Note

#### When three Controllers are connected to each other

Set the expression on the Controller having the larger CH No.  
The calculation result also is output from the Controller having the larger CH No.  
One of the calculation targets is always CH1.

 Output Data List p.90



RUN T FUN

# 1 Select the type of calculation.

- / Select [CALC].
- / Change the selection.
- Confirm the selection.

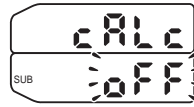

## When [WIDTH] is set

# 2 Set the width of the standard object.

- / The sub-display flashes.
- / Move from one digit to another.
- / Change the current value.
- Confirm the selection.



### Note Flow of measurement during calculation

The value after averaging of each CH is calculated.

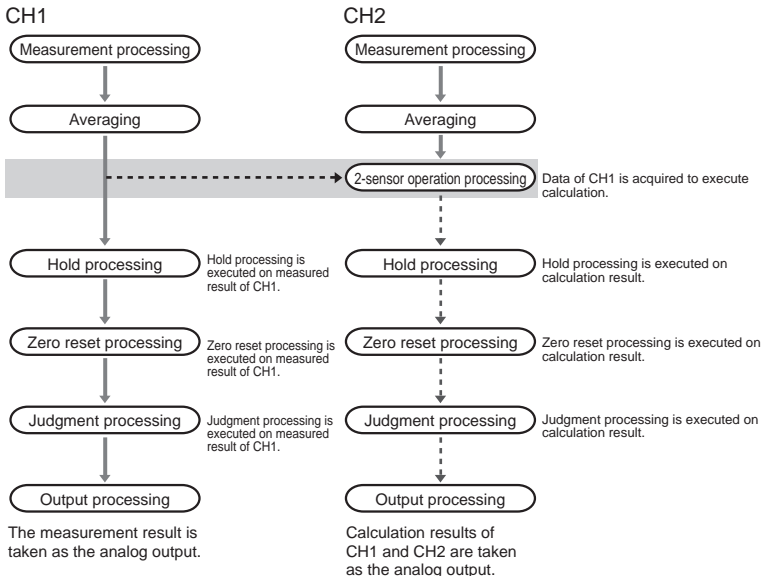

# Adjusting Detection Conditions

## Measurement Cycle

Normally, set the measurement cycle to the standard mode [NORM].





If the high-speed mode [FAST] is set, the measurement cycle speeds up but the Controller becomes more susceptible to the influence of ambient light.

Setting value	Description
NORM (Standard mode)	This mode is for performing measurement with laser emission from the emitter synchronized with the measurement timing of the receiver. However, the Controller becomes more resistive to the influence of ambient light. (default value)  <b>Important</b> Make sure that the Controller and Sensor sync wires are connected.
FAST (High-speed mode)	This mode is for performing measurement at high speed. Note, however, that the Controller becomes more susceptible to the influence of ambient light.



RUN T FUN

### 1 Select the measurement cycle.

-  /  Select [SPEED].
-  /  Change the selection.
-  Confirm the selection.



# Number of Samples to Average

The average of the set number of samples can be output as the measured value. Set this function to disregard sudden changes in the waveform.

Setting value	Description
1, 2, 4, 8, 16, 32, 64, 128, 256, 512, 1024, 2048, 4096	Setting the number of samples to average. (default value: 16)



## 1 Setting the number of samples to average.

- / Select [AVE].
- / Change the selection.
- Confirm the selection.



### Note

Average processing depends on the measurement mode, so the measurement cycle also changes. For IC lead pitch or pin diameter judgement, a simple average is used. For other measurement modes, a moving average is used.

### Measurement Cycle p.133

#### Moving Average

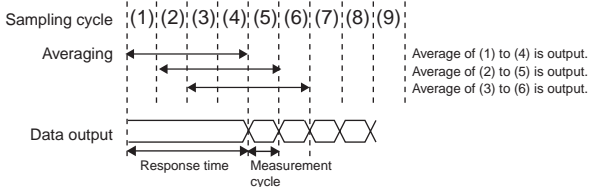

#### Simple Average

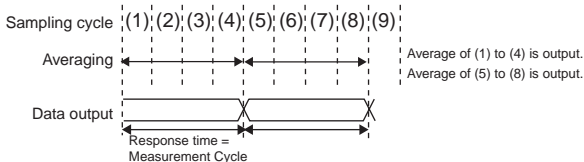



# Binary Level

Adjust the binary level to suit the optical transmittance of the measurement object.

Reference settings are as follows:

- Non-transparent object: 25% (default value)
- Transparent object/non-transparent object: 50% or more

## Note

When the measurement mode is the wire position measurement mode or the glass edge measurement mode, the binary level is automatically set to 50%.

## Important

The edge detection state changes when the binary level is changed.  
The edge detection state can be verified by the EDGEPOS command.





 p.123

Setting value	Description
25 to 90 (%)	Set the binary level. (default value: 25)











RUN T FUN

## 1 Select the special setting.

-  /  Select [SPCL].
-  /  Select [M-LV] or [ALL].
-  Confirm the selection.



## 2 Set the binary level.

-  /  Select [BIN.LV].
-  /  The sub-display flashes.
-  /  Move from one digit to another.
-  /  Change the current value.
-  Confirm the selection.



# Edge Filter

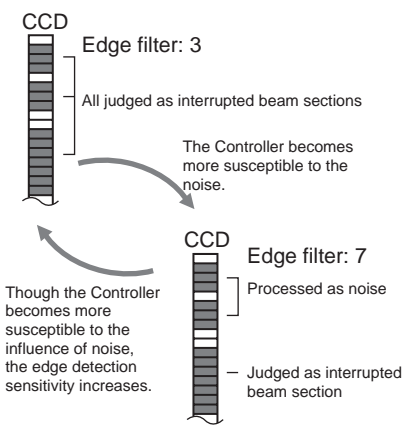

The edge filter for judging the interrupted beam section can be adjusted to suit your specific measurement requirements and the measurement object.

On the ZX-GT, the interrupted beam section is judged according to how many continuous pixels of the CCD's 2000 pixels in the receiver are blocked. These continuous pixels act as the edge filter. By adjusting this number of edge pixels, you can prevent noise and increase detection sensitivity.

Setting value	Description
3 to 7 (pixels)	Set the number of pixels to function as the edge filter. The setting differs according to the measurement mode. <ul style="list-style-type: none"> <li>When the wire position measurement mode or glass edge measurement mode is selected 3 to 7 (default value: 4)</li> <li>When another measurement mode is selected 7 (fixed)</li> </ul>



## 1 Select the special setting.

- / Select [SPCL].
- / Select [M-LV] or [ALL].
- Confirm the selection.

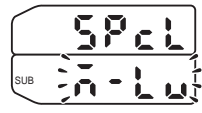

## 2 Set the edge filter.

- / Select [EG.FLT].
- / Change the current value.
- Confirm the selection.

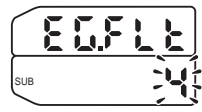

# Setting Output Conditions

## Judgment output timing (timer)

The timing for judgment outputs can be adjusted to match the operation of external devices.

Setting value	Description
OFF	<p>Outputs the judgment as soon as the judgment result has been confirmed. (default value)</p>
OFF-D (OFF delay)	<p>After the judgment result has been confirmed, delays the time required for the PASS output to turn OFF by the time set to timer. (Also delays turning OFF the HIGH and LOW outputs.)</p>
ON-D (ON delay)	<p>After the judgment result has been confirmed, delays the time required for the PASS output to turn ON by the time set to timer. (Also delays turning ON the HIGH and LOW outputs.)</p>

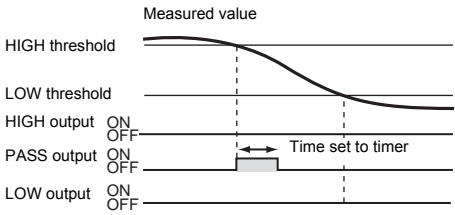
Setting value	Description
1-SHT (One-shot)	<p>When the measured value changes from HIGH to PASS or from LOW to PASS, turns ON the PASS output with a pulse width equivalent to the time set to the timer. Neither the HIGH nor the LOW output are output. Range: 0 to 5999 ms</p> 



## 1 Select the judgment output timing.

- / Select [TIMER].
- / Change the selection.
- Confirm the selection.

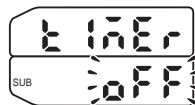

When other than [OFF] is set

## 2 Set the timer setting.

- Select [T-TIM].
- / The sub-display flashes.
- / Move from one digit to another.
- / Change the current value.
- Confirm the selection.



# Hysteresis

Set the hysteresis width (difference between operation point and return point) for the upper and lower limits of the judgments if the HIGH, PASS, or LOW judgment is unstable near the threshold values.

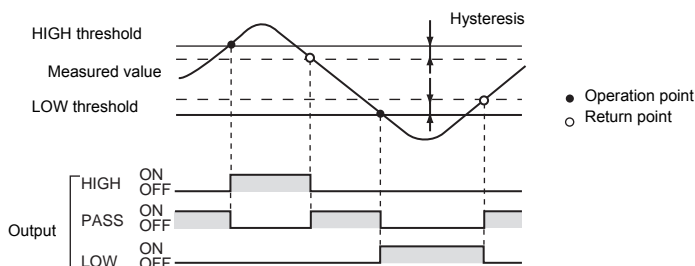

Setting value	Description
00.000 to 59.999 (mm)	Sets the hysteresis width. (default value: 00.100)



## 1 Select the hysteresis setting.

- / Select [HYS].
- Confirm the selection.

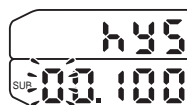

## 2 Change the current value.

- / The sub-display flashes.
- / Move from one digit to another.
- / Change the current value.
- Confirm the selection.

# Analog Output Conditions

## Setting Output Scaling

With analog output, the relationship between the displayed measured value and output value can be freely set as the measurement result is converted to a current of 4 to 20 mA or a voltage of -5 to +5 V, and is then output. Match the settings to suit the connected external device.

Enter the output values for any two current values or voltage values to set the output range.

Example: Set 10 mm to 4 mA, and 28 mm to 20 mA. (for current output)

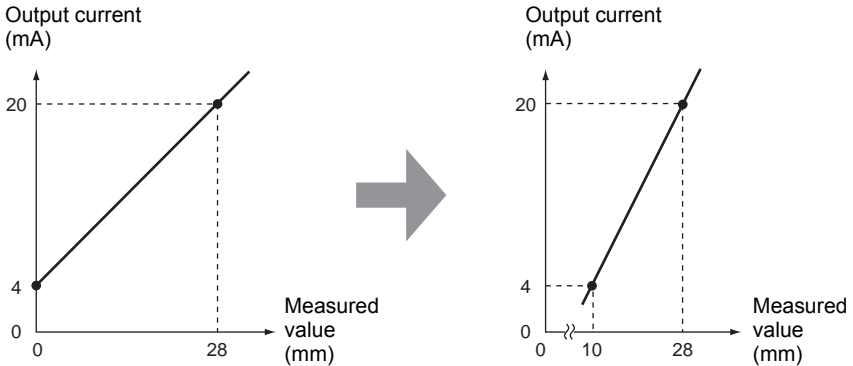

### Note

In the IC lead pitch and IC lead width judgment modes, there are no measured value outputs. Analog outputs are as follows:

- Voltage output: 0 V
- Current output: 4 mA

This section uses a current output as an example. Change the values in this example for voltage output as necessary.



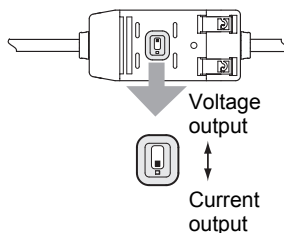

# 1 Switch the voltage/current switch to current output.

## Important

Be sure to perform the following with the Controller turned OFF.







# 2 Select the special setting.

-  /  Select [SPCL].
-  /  Select [OUT] or [ALL].
-  Confirm the selection.



# 3 Set output scaling.



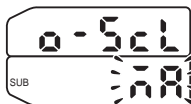

-  /  Select [O-SCL].
-  /  Change the selection.
-  Confirm the selection.



## Important



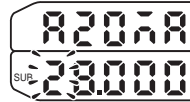

Be sure to set the same selections as the setting made on the current/voltage switch on the rear of the Controller.

#### 4 Set the scale of the 1st point.

-  /  Move from one digit to another.
-  /  Change the current value.
-  Confirm the selection.



#### 5 Set the scale of the 2nd point.

-  /  Move from one digit to another.
-  /  Change the current value.
-  Confirm the selection.



#### 6 Check that setting of output scaling is completed.

If output scaling has been set correctly



If output scaling has not been set correctly



#### Note

If output scaling has not been set correctly, check the following points:

- Is the measured value on the sub-display set to a value within the measuring range?  
(The content of zero reset or calculation is also reflected if set.)
- Are the first and second points separated by at least 1% of the rated measurement distance?
- Are the current (or voltage) values for the first and second points the same?



## Correcting Analog Output Values

Discrepancies may occur between the analog output current (or voltage) values set on the Controller and the actual measured current (or voltage) values due to the conditions for the connected external device or other factors. The analog output correction function can be used to correct this discrepancy. The output values are corrected by entering the correction value for the current (or voltage) values for any two points.

### Important

Set scaling beforehand, and select current output or voltage output. Also, connect the analog output wire to an external ammeter or voltmeter.

This section uses a current output as an example. Change the values in this example for voltage output as necessary.



### 1 Select the special setting.

- / Select [SPCL].
- / Select [OUT] or [ALL].
- Confirm the selection.



### 2 Switch to correction of analog output.

- / Select [A-ADJ].
- Confirm the selection.



### 3 Set the correction value for the first point.

- / Move from one digit to another.
- / Change the current value.
- Confirm the selection.



### 4 Set the correction value for the second point.

- / Move from one digit to another.
- / Change the current value.
- Confirm the selection.



- 5** Check that setting of correction values is completed.



# Setting Hold Functions

Set hold conditions for measured values. The hold functions hold data for specific points, such as the minimum or maximum value, during the sampling period (sampling time), and output those values at the end of the sampling period.



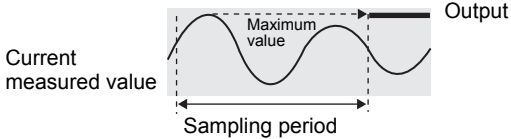
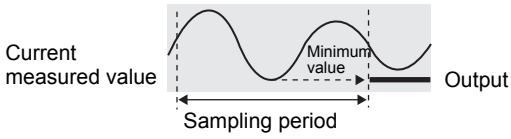
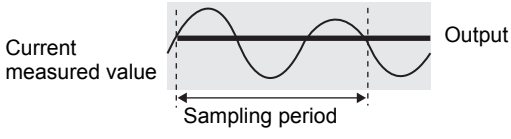

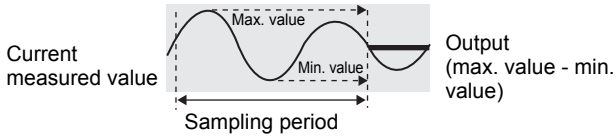
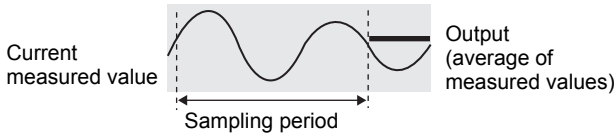
## Hold

Setting value	Description
OFF	Hold measurement is not performed. The measured value is output at all times. (default value)
P-H (Peak hold)	<p>The maximum value is held during the sampling period. The output changes at the end of the sampling period, and is held until the end of the next sampling period.</p>  <p>Current measured value</p> <p>Maximum value</p> <p>Output</p> <p>Sampling period</p>
B-H (Bottom hold)	<p>The minimum value is held during the sampling period. The output changes at the end of the sampling period, and is held until the end of the next sampling period.</p>  <p>Current measured value</p> <p>Minimum value</p> <p>Output</p> <p>Sampling period</p>
SMPLE (Sample hold)	<p>The measured value is held at the start of the sampling period. The output changes at the start of the sampling period and is held until the start of the next sampling period.</p>  <p>Current measured value</p> <p>Output</p> <p>Sampling period</p>

Setting value	Description
PP-H (Peak-to-peak hold)	<p>The difference between the minimum and maximum values is held. This option is selected mainly when detecting vibration. The output changes at the end of the sampling period, and is held until the end of the next sampling period.</p> 
AVE-H (Average hold)	<p>The average measured value during the sampling period is held. The output changes at the end of the sampling period, and is held until the end of the next sampling period.</p> 



## 1 Select the hold conditions.

-  /  Select [HOLD].
-  /  Change the selection.
-  Confirm the selection.



## 2 Enter the trigger for measurement in the hold mode.

Connect the Controller's timing input signal wire, or enter the trigger for starting sampling using the ↑ UP key.

# Delay Hold

The delay time is set to ignore measured values immediately after the timing input. This is useful for avoiding bounding during device startup and the influence of machine vibration. The delay time (the delay between timing input and start of sampling) and the sampling period can be set.

Setting value	Description
OFF	The delay time is not set. (default value)
ON	<p>The delay time is set.</p> <p>After selecting this value, set the following items:</p> <ul style="list-style-type: none"> <li>• Delay Time Set the delay time. Range: 0 to 5999 (ms)</li> <li>• Sampling Time Set the sampling time (or sampling period). Range: 0 to 5999 (ms)</li> </ul> <p><b>Important</b></p> <p>Set so that the sum of the delay time and sampling time is less than the timing input ON interval. If the next timing input for measurement is received before the "sum of delay time and sampling time" has elapsed, that timing input will be ignored and will not be reflected in the sampling.</p>



RUN T FUN

# 1 Select the hold conditions.

Set the hold conditions. p.73



# 2 Set the delay hold.

- / Set the delay hold.
- / Change the selection.
- Confirm the selection.



# 3 Set the delay time.

- / Select [H-D-T].
- / The sub-display flashes.
- / Move from one digit to another.
- / Change the current value.
- Confirm the selection.

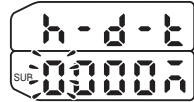

# 4 Set the sampling time.

- / Select [H-S-T].
- / The sub-display flashes.
- / Move from one digit to another.
- / Change the current value.
- Confirm the selection.

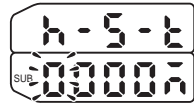

# Changing Display Conditions

## Reversing the Display

The main display and sub-display can be reversed, i.e., be turned upside down. Cursor key operations also will be reversed. This function is useful when the Controller is mounted upside down on a device.

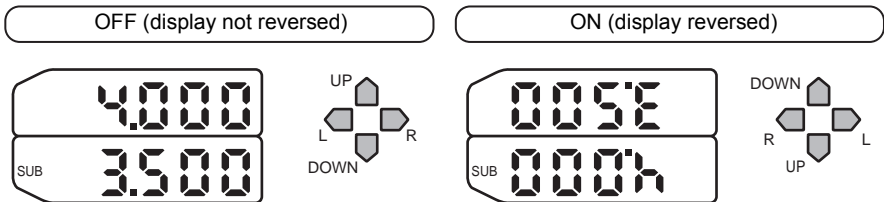

Setting value	Description
OFF	The display is not reversed. (default value)
ON	The display is reversed.



### 1 Select the special setting.

- / Select [SPCL].
- / Select [DISP] or [ALL].
- Confirm the selection.

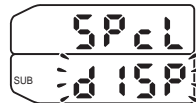

### 2 Set display reverse.

- / Select [DREV].
- / Change the selection.
- Confirm the selection.

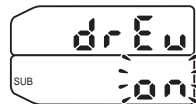

# Changing the Number of Display Digits

Set the number of digits displayed on the main display and sub-display in the RUN mode. When four or less digits are set, the digits are disabled from the rightmost digit first. If 0 digits are set, all of the digital displays will go out.

Setting value	Description
0-DIG, 1-DIG, 2-DIG, 3-DIG, 4-DIG, 5-DIG	Set the number of display digits. (default value: 5-DIG)



## 1 Select the special setting.

- / Select [SPCL].
- / Select [DISP] or [ALL].
- Confirm the selection.

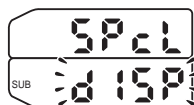

## 2 Set the number of display digits.

- / Select [DIGIT].
- / Change the selection.
- Confirm the selection.

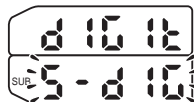



# Adjusting the Display Brightness (ECO mode)

When the ECO mode display function is used, the main display and sub-display are not lit, reducing current consumption.

Setting value	Description
OFF	The main display and sub-display are lit at their regular brightness. (default value)
ON	The displays are not lit.



## 1 Select the special setting.

- / Select [SPCL].
- / Select [DISP] or [ALL].
- Confirm the selection.



## 2 Set the ECO mode.

- / Select [ECO].
- / Change the selection.
- Confirm the selection.

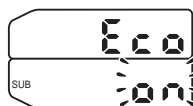

# Setting Communication Conditions

## RS-232C Communications Specifications

Set the communication specifications for the Controller matched to the communications specifications of external devices. After setting the communications specifications, the Controller must be turned OFF then back ON again to enable the settings.

Setting value	Range
BPS (baud rate)	1200, 2400, 4800, 9600, 19200, 38400 (default value: 38400)
LEN (data length)	7, 8 (default value: 8)
S.BIT (stop bit)	1, 2 (default value: 1)
PRTY (parity)	NONE (none), ODD (odd), EVEN (even) (default value: NONE)
HD.FT (header/footer selection)	ST.ET (STX+ETX), CR, CR.LF (CR+LF) (default value: CR)



RUN T FUN

### 1 Select the special setting.

- /  Select [SPCL].
- /  Select [IFU] or [ALL].
- Confirm the selection.



### 2 Set the baud rate.

- /  Select [BPS].
- /  Change the selection.
- Confirm the selection.



### 3 Set other items by the same procedure.

# Setting the Binary Output Cycle

Set the cycle at which binary output is performed. After setting the binary output cycle, the Controller must be turned OFF then back ON again to enable the settings.

Setting value	Description
1 to 500 (ms)	Set the output cycle. (default value: 1) The measurement result is output at the output cycle you set here.



RUN T FUN

## 1 Select the special setting.

- / Select [SPCL].
- / Select [IFU] or [ALL].
- Confirm the selection.

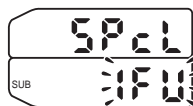

## 2 Set the output cycle.

- / Select [CYCLE].
- / Change the selection.
- Confirm the selection.



# Special Functions

## Zero Reset Memory

Select whether or not to hold the measured value after the zero reset was performed (zero reset level) when the power is turned OFF.

Setting value	Range
OFF	Zero reset is canceled when the power is turned OFF. (default value)
ON	The zero reset level is saved when the power is turned OFF.





### Important

If zero reset memory is set to [ON], the zero reset level will be written in the Controller's non-volatile memory (EEPROM) each time a zero reset is performed. The EEPROM can be written a maximum of 100,000 times. Setting the zero reset memory to [ON] can, therefore, use up the life of the memory and lead to malfunctions.

 Executing and Canceling a Zero Reset p.47







### 1 Select the special setting.

-  /  Select [SPCL].
-  /  Select [ETC] or [ALL].
-  Confirm the selection.



### 2 Set zero reset memory.

-  /  Select [ZRMEM].
-  /  Change the selection.
-  Confirm the selection.



# Display during a Zero Reset

Set the zero reset memory function to set the reference value to a value other than 0 (zero).

Setting value	Range
00.000 to 59.999 (mm)	Set the reference value. (default value: 00.000)



RUN T FUN

## 1 Select the special setting.

- / Select [SPCL].
- / Select [ETC] or [ALL].
- Confirm the selection.



## 2 Set the reference value.

- / Select [ZRDSP].
- / The sub-display flashes.
- / Move from one digit to another.
- / Change the current value.
- Confirm the selection.



# Key Lock

The key lock function disables all Controller keys. Once the keys have been disabled, no key input will be accepted until the lock is canceled. This function is useful for preventing inadvertent changes to settings. The mode and threshold switches are still enabled even when the key lock function is ON.

## Setting the Key Lock



### 1 Apply the key lock.



Hold down these keys until [OK] is displayed, and then release the keys.

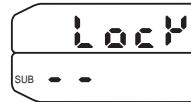

## Canceling the Key Lock



### 1 Cancel the key lock.



Hold down these keys until [OK] is displayed, and then release the keys.

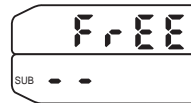

# Switching Banks

The ZX-GT can hold up to two sets of settings, which are called a "bank". Banks can be switched from an external device when changing the device setup.

## Important

The following data can be saved in memory as settings of banks.

- HIGH and LOW thresholds
- Hysteresis width
- Number of IC leads, IC lead pitch, IC lead pitch tolerance (IC lead pitch judgment mode)
- Number of IC leads, IC lead width, IC lead width tolerance (IC lead width judgment mode)
- The first and second specified edges (Specified edge measurement mode)

## Setting the Bank Switching Source

Set from where switching of banks is to be instructed.

Setting value	Description
KEY	Bank switching is performed by operating the control keys. (default value)
I-O	Bank switching is performed from an external device on the bank switching input wire on the Controller.



RUN T FUN

### 1 Select the special setting.

- / Select [SPCL].
- / Select [BANK] or [ALL].
- Confirm the selection.



### 2 Set the I/O conditions.

- / Select [BK.IN].
- / Change the selection.
- Confirm the selection.

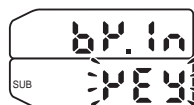

## Bank Switching (change of device setup)

The currently selected bank can be switched to the other bank.

### Switching banks by operating the control keys





When [KEY] is set as the source from where banks are to be switched, the banks can be switched by operating the control keys on the Controller.

 Setting the Bank Switching Source p.85

Setting value	Description
1, 2	Selects the target bank. (default value: 1)







#### 1 Select the special setting.

-  /  Select [SPcL].
-  /  Select [BANK] or [ALL].
-  Confirm the selection.



#### 2 Set the bank.

-  /  Select [S.BANK].
-  /  Change the selection.
-  Confirm the selection.



### Switching banks by external signal input

When [I-O] is set as the source from where banks are to be switched, the banks can be switched from an external device on the bank switching input wire on the Controller.

-  • Setting the Bank Switching Source p.85
- Assignments and Functions of I/O Signal Wires p.91



# Displaying the System Version

Display the system (Controller and Sensor) version.

Setting value	Range
CONT	Displays the Controller version. (default value)
HEAD	Displays the Sensor version.



RUN T FUN

## 1 Select the version display.

- / Select [INFO].
- / Change the selection.
- Confirm the selection.

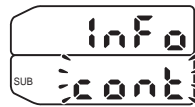

## 2 Check the version information.

The version information for the selected item is displayed.

- / Exit the version display.



MEMO

# COMMUNICATIONS WITH EXTERNAL DEVICES

<b>Output Data List</b>	<b>90</b>
<b>Communications Using the Controller I/O Cable</b>	<b>91</b>
Using the Controller I/O Cable	91
<b>Binary Output</b>	<b>93</b>
Assignments and Functions of Output Signal Wires	93
Output Format	94
<b>I/O Timing Charts</b>	<b>95</b>
<b>RS-232C</b>	<b>100</b>
Communications on the RS-232C Interface	100
Connecting External Devices	101
About Communications Commands	102
Setting Acquisition/Change Commands	107
Measurement Control/Measured Value Acquisition Commands	123
Bank Control Command	127
Utility Command	128

# Output Data List

ZX-GT can output three types of data (measured values, judgment results and results of calculation performed on multiple Controllers) to external devices. Also, by connecting an Interface Unit, measured data can be output in binary or by RS-232C communications in addition to analog output on the Controller I/O cable.

Output path		Outputs
Controller		<ul style="list-style-type: none"> <li>• Judgment output by HIGH/PASS/LOW</li> <li>• Output of voltage or current as analog values in accordance with the measured value</li> </ul>
Interface Unit	Binary	Output of measured values as binary values
	RS-232C	Output of measured values/judgments according to command input

## When Three Controllers are Connected to Each Other

Calculations can be performed on up to two channels. One of the channels in the calculation is always CH1. One of the channels in the calculation is always fixed to CH1. Set the expression on the Controller having the larger CH No.

Output path		Outputs	
		With calculation	Without calculation
Controller	CH1	Output of measured value/judgment of CH1	
	CH2	Output of calculation result of CH1 and CH2	Output of measured value/judgment of CH2
	CH3	Output of calculation result of CH1 and CH3	Output of measured value/judgment of CH3
Interface Unit	Binary	Output of measured value of largest CH	
	RS-232C	Output of measured value/judgment of CHx or all CHs	



# Communications Using the Controller I/O Cable

## Using the Controller I/O Cable

By using the Controller's I/O cable, you can output the measured value or judgment result to external devices, or input a control signal, such as zero reset or LD-OFF, from external devices. A predetermined I/O signal is assigned to each signal wire of the I/O cable.

### Assignments and Functions of I/O Signal Wires

#### Assignment of output signal wires

Cable color	Function	Signal	Description
White	Judgment output <sup>(*1)</sup>	HIGH	Turns ON when measured value > HIGH threshold.
Green		PASS	Turns ON when LOW threshold ≤ measured value ≤ HIGH threshold.
Gray		LOW	Turns ON when measured value < LOW threshold.
Co-axial (black)	Analog output <sup>(*2)</sup>		Outputs the analog value corresponding to the measured value. 4 to 20 mA current or -5 to +5 V voltage can be selected. (Select this by the current/voltage switch on the rear of the Controller.)  Part Names and Functions p.22  <b>Note</b>  With analog output, output values can be scaled or corrected to suit the conditions of the connected external device.   Setting analog output conditions p.68

\*1: In the IC lead pitch and IC lead width judgment modes, both the HIGH and LOW outputs turn ON when the judgment result is NG.

\*2: In the IC lead pitch and IC lead width judgment modes, 0 V or 4 mA is output at all times.

## Assignment of input signal wires

Cable color	Signal	Function
Pink	Bank switching input	<p>Bank 1 is selected when this input is OFF, and bank 2 is selected when this input is ON. Bank switching is enabled only when the bank switching source is set to "I-O".</p> <p> Switching Banks p.85</p>
Orange	Zero reset input	<p>Sets the measured value to zero.</p> <ul style="list-style-type: none"> <li>• At zero reset execution Turn the zero reset signal ON for 0.2 to 0.8 seconds. After the zero reset signal turns OFF, the zero reset is executed within one measurement cycle.</li> <li>• At zero reset cancellation Turn the zero reset signal ON for at least 1 second. The zero reset is cancelled within one measurement cycle after 1 second elapses.</li> </ul>
Purple	Timing input	<p>Use this input for hold function timing. The sub-display will show "TIMIG" while the hold function timing is input.</p>
Red	Reset input	<p>This input resets all outputs. When this input is ON, internal calculations are discontinued, all judgment outputs are turned OFF, and the maximum value (approx. 5.5 V at voltage output or 23 mA at current output) is output as the analog output. The sub-display will show "RESET" while the reset is input.</p>

# Binary Output

## Assignments and Functions of Output Signal Wires

Measured values can be converted to 12-bit binary data and output on the Interface Unit output cables.

Cable color	Signal name	Bit assignment	Description
Purple	D0	b0	Binary data output signal wires
Red	D1	b1	
Orange	D2	b2	
White	D3	b3	
Green	D4	b4	
Gray	D5	b5	
Pink	D6	b6	
Blue	D7	b7	
Brown	D8	b8	
Yellow	D9	b9	
Black	D10	b10	
Red/ white	D11	b11	
Light blue	GATE	-	GATE signal output wire (sync signal for data acquisition from external device) Data is acquired when this signal is ON.

# Output Format

Measured values and calculation values are converted to a 12-bit binary number (in the case of minus values, 2's complement) before they are output. Bit expressions are output using minus logic ("1" when open output is ON).

The output cycle of binary output can be set on the Controller.



Binary output cycle p.81

## < Output Format >

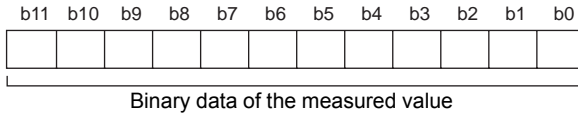

## < Output of Measured Values (example) >

Output of measurement standby

b11	b10	b9	b8	b7	b6	b5	b4	b3	b2	b1	b0
0	0	0	0	0	0	0	0	0	0	0	0

When measured value is "+12.34"

b11	b10	b9	b8	b7	b6	b5	b4	b3	b2	b1	b0
0	1	0	0	1	1	0	1	0	0	1	0

When measured value is "-12.34"

b11	b10	b9	b8	b7	b6	b5	b4	b3	b2	b1	b0
1	0	1	1	0	0	1	0	1	1	1	0

### Note

When a measurement result error occurs, the previous output status is held.



# I/O Timing Charts

This section explains the I/O signals that are exchanged between the Controller and external devices, and the timing charts for data output.

## Measurement cycle: Standard mode (NORM)

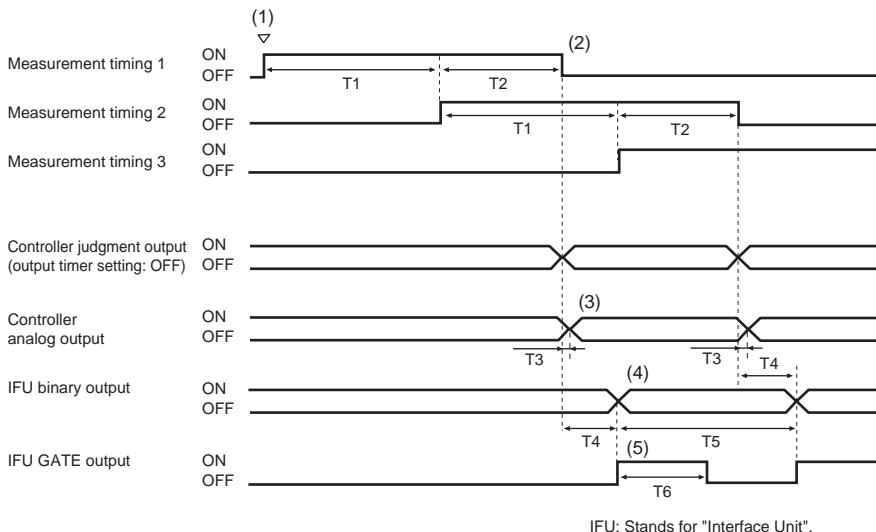

T1: Measurement cycle	The measurement cycle is 1.5 ms.
T2: Measurement processing time	This is the time required until the measured data is applied. (max. 1 ms)
T3: Analog output response time	This is the time until the Controller starts analog output after completion of measurement. (100 $\mu$ s)
T4: IFU binary output response time	This is the time until the Interface Unit starts binary output after completion of measurement. This time differs according to the number of Controllers connected to each other. (0.5 ms x number of connected Controllers + 0.5 ms)
T5: Binary output cycle	This is the time in which the Interface Unit outputs the binary data. This time can be changed. (1 to 500 ms (default value: 1 ms))
T6: GATE ON time	This is the time that the GATE signal is ON. This time differs according to the currently set binary output cycle. (binary output cycle setting x 0.5) This is the time that is required to capture data output (measured values/judgment results) on external devices.

## Explanation of Operation

- (1) Continuous measurement is started the moment that the mode changes to the RUN mode.
- (2) When measurement ends and the measurement processing time elapses, the measured data is applied and output.
- (3) Analog output is started after the measured data is applied and the analog output response time (T3) elapses.
- (4) Output is executed for the time specified as the binary output cycle after the IFU binary output response time (T4) elapses and the measured data is applied.
- (5) The GATE signal turns ON for the predetermined time and measured data is captured on the external device after measured data is applied and the IFU binary output response time (T4) elapses.

### Measurement cycle: High-speed mode (FAST)

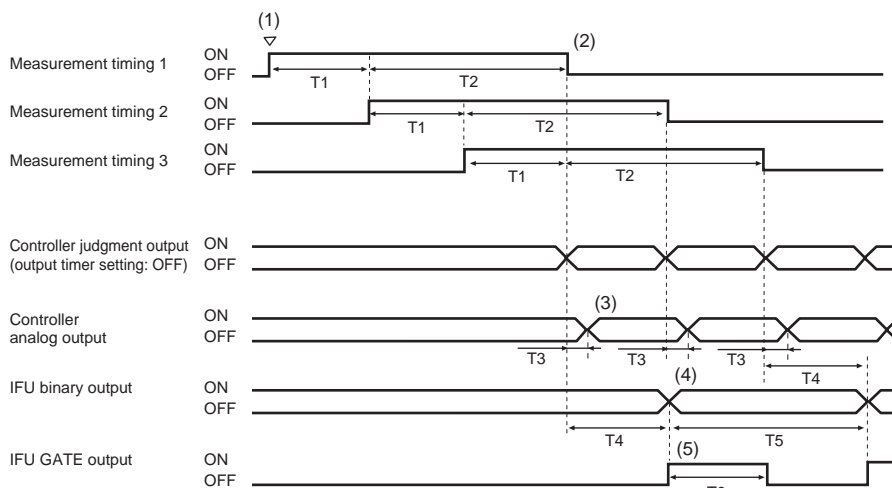

IFU: Stands for "Interface Unit".

T1: Measurement cycle	The measurement cycle is 0.5 ms. Note, however, that the response time is 1 ms in the IC lead pitch and IC lead width judgment modes.
T2: Measurement processing time	This is the time required until the measured data is applied. (max. 1 ms) Note, however, that the response time is 1.5 ms in the IC lead pitch and IC lead width judgment modes.
T3: Analog output response time	This is the time until the Controller starts analog output after completion of measurement. (100 μs)

T4: IFU binary output response time	This is the time until the Interface Unit starts binary output after completion of measurement. This time differs according to the number of Controllers connected to each other. (0.5 ms x number of connected Controllers + 0.5 ms)
T5: Binary output cycle	This is the time in which the Interface Unit outputs the binary data. This time can be changed. (1 to 500 ms (default value: 1 ms))
T6: GATE ON time	This is the time that the GATE signal is ON. This time differs according to the currently set binary output cycle. (binary output cycle setting x 0.5) This is the time that is required to capture data output (measured values/judgment results) on external devices.

### Explanation of Operation

- (1) Continuous measurement is started the moment that the mode changes to the RUN mode.
- (2) When measurement ends and the measurement processing time elapses, the measured data is applied and output.
- (3) Analog output is started after the measured data is applied and the analog output response time (T3) elapses.
- (4) Output is executed for the time specified as the binary output cycle after the IFU binary output response time (T4) elapses and the measured data is applied.

#### Important

The minimum binary output cycle is 1 ms. Because the measurement cycle in the high-speed mode (FAST) is 0.5 ms, binary output from the Interface Unit is executed once every two measurements.

- (5) The GATE signal turns ON for the predetermined time and measured data is captured on the external device after measured data is applied and the IFU binary output response time (T4) elapses.

## Trigger input

When delay hold setting is OFF



When delay hold setting is ON

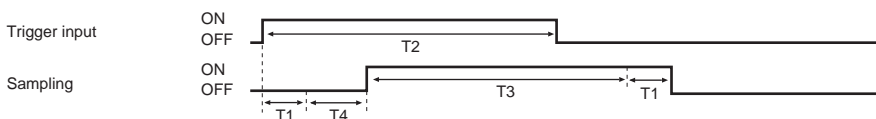

T1: Trigger input response time	This is the time until the change in the ON/OFF state of the hold trigger is recognized as the trigger. Standard mode (NORM): max. 2.0 ms High-speed mode (FAST): max. 1.0 ms
T2: Trigger input time	This is the time that the trigger input is held until hold processing is completed. This time must be set to at least 1 ms.
T3: Sampling time	This is the time for ensuring hold processing. This time can be changed. Range: 0 to 5999 ms
T4: Delay time	This is the time until hold processing is started after trigger input. Range: 0 to 5999 ms

## Laser OFF input (Sensor)

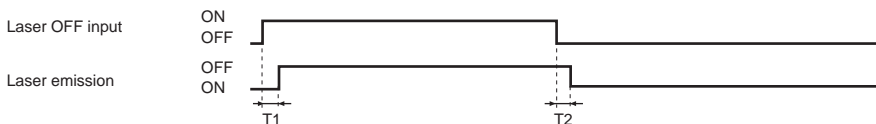

T1: Laser OFF input response time	This is the time after the laser OFF signal is input until laser emission is stopped. 5 $\mu$ s or less
T2: Laser restore response time	This is the time after the laser OFF signal is canceled until laser emission is started. 40 $\mu$ s or less

## Bank switching time

The time after execution of bank switching until output of measurement results is started is "50 ms + output response time x averaging number". The output response time differs as follows according to the output destination and settings. Also, the trigger cannot be input during bank switching. Bank switching is enabled only when the bank switching setting is set to "external input wire."

### Output response time (maximum)

	Standard mode (NORM)	High-speed mode (FAST)
Judgment output	2.5 ms	1.5 ms
Analog output	2.5 ms	1.5 ms
IFU binary output	Number of connected Controllers x 0.3 ms + 2.8 ms	Number of connected Controllers x 0.3 ms + 1.8 ms

## Reset input

Input the reset signal for at least 1 ms. After a reset input, output turns OFF "within the output response time x averaging number." (analog output maximum value: approx. 5 V/ approx. 23 mA)

# RS-232C

## Communications on the RS-232C Interface

You can use the RS-232C connector of the Interface Unit to perform serial communication with external devices such as a PC or PLC.

### Communications Interface Specifications

This interface allows data communications compliant with the EIA RS-232C standard up to a maximum speed of 38400 bps.

Communication method	Full duplex
Synchronization method	Start-stop
Transmission code	ASCII
Baud rate	1200, 2400, 4800, 9600, 19200, 38400 (bps)
Data length	7, 8 (bits)
Stop bit	1, 2 (bits)
Parity	NONE (none), ODD (odd), EVEN (even)
Header/footer	ST.ET (STX+ETX), CR, CR.LF (CR+LF)



Communications on the RS-232C interface p.80

### Communication Method

The ZX-GT uses the "command response method."

By this method, command processing is executed when a command is sent to the Controller from an external device, and a response is returned to the external device from the Controller, when command processing ends. An error response is returned when the command sent from the external device is in error or when an error occurs during command processing on the Controller.

When commands are issued continuously, issue the next command after the response is received.

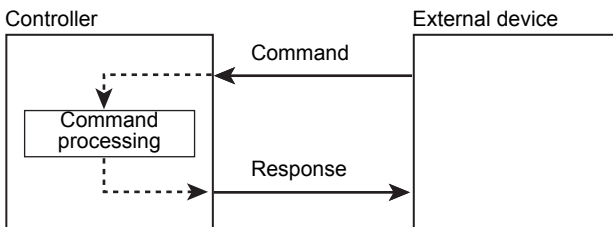

# Connecting External Devices

## Important

First, connect the Interface Unit to the Controller.

 Connecting Interface Units p.38

## Connecting a PC/PLC

You can use the RS-232C connector of the Interface Unit to perform serial communication with a PC or PLC.

## Important

When connecting to a PC or PLC, refer to the respective instruction manual.

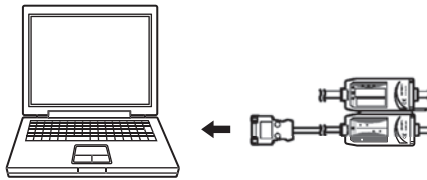

### Connector Pin Arrangement and Connection Example with a PC

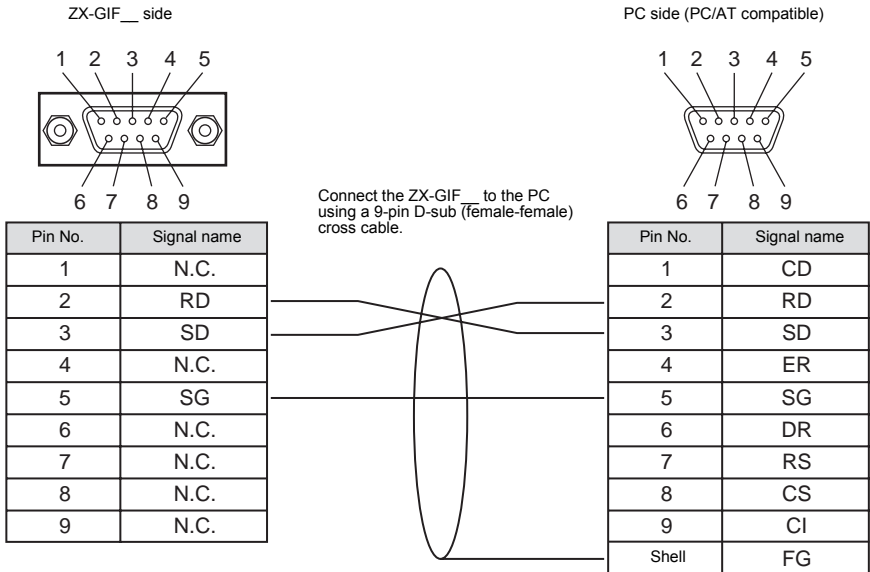

\* Pin Nos. may vary with the type and model of the external device to be connected. For details, refer to the instruction manual of your PC or PLC.

# About Communications Commands

## Command/Response Format

### Important

The command/response format differs according to the RS-232C communications specifications. [CR] has been selected prior to shipment from the factory.

## When [CR] or [CR.LF(CR+LF)] is selected

### < Command >

When there is only one Controller connected

Command data	Delimiter
--------------	-----------

When multiple Controllers are connected to each other

#	Channel No.	Space	Command data	Delimiter
---	-------------	-------	--------------	-----------

### < Response >

When processing ends successfully

Response data	Delimiter
---------------	-----------

O	K	Delimiter
---	---	-----------

When processing fails

E	R	Delimiter
---	---	-----------

Command data	Specifies the command and parameters.	
Channel No.	When multiple Controllers are connected to each other, the channel No. is specified in front of the command. (01 to 03) The default channel No. is channel "01". <table border="1"><tr><td>Note</td></tr></table> "99" can be specified to target all channels only when the MEASURE command is issued.	Note
Note		
Response data	Stores the acquired data.	
Delimiter	This control code indicates the end of the data. Either CR or CR+LF is used.	



## When [ST.ET (STX+ETX)] is selected

### < Command >

When there is only one Controller connected

Header	Command data	Footer
--------	--------------	--------

When multiple Controllers are connected to each other

Header	#	Channel No.	Space	Command data	Footer
--------	---	-------------	-------	--------------	--------

### < Response >

When processing ends successfully

Header	Response data	Footer
--------	---------------	--------

Header	O	K	Footer
--------	---	---	--------

When processing fails

Header	E	R	Footer
--------	---	---	--------

Header	This control code indicates the end of the data. Use STX.
Channel No.	When multiple Controllers are connected to each other, the channel No. is specified in front of the command. (01 to 03) The default channel No. is channel "01".  <b>Note</b>  "99" can be specified to target all channels only when the MEASURE command is issued.
Command data	Specifies the command and parameters.
Response data	Stores the acquired data.
Footer	This control code indicates the end of the data. Use ETX.

## Configuration of measured value data

Acquired measured values are output as a data structure of variable length of up to 6 characters including the sign but excluding the delimiter.

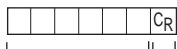

Delimiter

Sign + integer: 6 digits

(The measured value is prefixed with spaces for the number of insufficient data.)

Sign	"-" is stored when the sign of the measured value is a minus value.																																
Integer	<p>When the measured value is less than 6 characters, it is prefixed with spaces for the number of insufficient data. (without digits past the decimal point)</p> <p>&lt; Measured value &gt; &lt; Data configuration &gt;</p> <p>+12.345      <table border="1"><tr><td> </td><td>1</td><td>2</td><td>3</td><td>4</td><td>5</td><td>CR</td></tr></table></p> <p>+1.234      <table border="1"><tr><td> </td><td> </td><td>1</td><td>2</td><td>3</td><td>4</td><td>CR</td></tr></table></p> <p>-12.345      <table border="1"><tr><td>-</td><td>1</td><td>2</td><td>3</td><td>4</td><td>5</td><td>CR</td></tr></table></p> <p>At measurement error      <table border="1"><tr><td> </td><td>6</td><td>5</td><td>5</td><td>3</td><td>4</td><td>CR</td></tr></table> (same after a reset)</p> <p>&lt; Judgment result &gt; &lt; Data configuration &gt;</p> <p>PASS      <table border="1"><tr><td>P</td><td>CR</td></tr></table></p> <p>NG      <table border="1"><tr><td>N</td><td>CR</td></tr></table></p>		1	2	3	4	5	CR			1	2	3	4	CR	-	1	2	3	4	5	CR		6	5	5	3	4	CR	P	CR	N	CR
	1	2	3	4	5	CR																											
		1	2	3	4	CR																											
-	1	2	3	4	5	CR																											
	6	5	5	3	4	CR																											
P	CR																																
N	CR																																

## Available Commands

### Setting Acquisition/Change Commands

Command name	Description	Reference
AVERAGE	Sets the number of samples to average.	p.107
	Acquires the current number of samples to average.	p.107
BINLV	Sets the binary level.	p.108
	Acquires the current binary level.	p.108
EDGENUM	Sets two edges whose width is to be obtained.	p.109
	Acquires the setting of current specified edges 1/2.	p.110
HOLDMODE	Sets the hold conditions.	p.111
	Acquires the current hold conditions.	p.112
HYS	Sets the hysteresis width.	p.113
	Acquires the current hysteresis.	p.113
JUDPARA	Sets the judgment thresholds.	p.114
	Acquires the current HIGH/LOW thresholds.	p.115
MEASMODE	Switches the current measurement mode.	p.116
	Acquires the current measurement mode.	p.117
PINNO	Sets the number of IC leads.	p.118
	Acquires the current number of IC leads setting.	p.119
REF	Sets the IC lead pitch/IC lead width standard values.	p.120
	Acquires the current IC lead pitch/IC lead width standard values.	p.121
TEACH	Registers the all incident light state as the standard received light intensity.	p.121
TOL	Sets the IC lead pitch/IC lead width tolerance values.	p.122
	Acquires the current IC lead pitch/IC lead width tolerance values.	p.122

## Measurement Control/Measured Value Acquisition Commands

Command name	Description	Reference
EDGEPOS (or E)	Acquires the current number of edges/edge positions.	p.123
MEASURE (or M)	Acquires measured values/judgment results.	p.124
ZERO	Executes a zero reset.	p.126
	Cancels a zero reset.	p.126

## Bank Control Command

Command name	Description	Reference
BANK	Switches the current bank.	p.127
	Acquires the current bank No.	p.127

## Utility Command

Command name	Description	Reference
DATAINIT	Returns all Controller setup data to their defaults.	p.128



## Set/Acquire Binary Level < BINLV command >

### Setting the binary level

Sets the binary level.

#### < Command format >

B I N L V   C<sub>R</sub>

Binary level (max. 2 digits)

#### < Response format >

When processing ends successfully

O K C<sub>R</sub>

When processing fails

E R C<sub>R</sub>

#### < Explanation of parameters >

Binary level	Specifies the binary level. (25 to 90%)
--------------	---

### Acquiring the binary level

Acquires the current binary level.

#### < Command format >

B I N L V C<sub>R</sub>

#### < Response format >

When processing ends successfully

C<sub>R</sub>

Binary level (max. 2 digits)

When processing fails

E R C<sub>R</sub>

#### < Explanation of parameters >

Binary level	The acquired binary level is returned. (25 to 90%)
--------------	--



## Acquiring specified edge 1/2

Acquires the setting of current specified edges 1/2.

### < Command format >

- Specified edge 1

E D G E N U M 0 C<sub>R</sub>

- Specified edge 2

E D G E N U M 1 C<sub>R</sub>

### < Response format >

When processing ends successfully

□ □ C<sub>R</sub>

└──┬──┘  
Edge No. (max. 2 digits)

When processing fails

E R C<sub>R</sub>

### < Explanation of parameters >

Edge No.	The edge No. of the acquired specified edge 1/2 is returned. (1 to 30, 49, 50)
----------	---



## Set/Acquire Hold Conditions < HOLDMODE command >

### Setting hold conditions

Sets the hold conditions.

#### < Command format >

H O L D M O D E    C R

└──┬──┘ Hold conditions

#### < Response format >

When processing ends successfully

O K C R

When processing fails

E R C R

#### < Explanation of parameters >

Hold conditions	Specifies the hold conditions. 0: OFF 1: P-H (Peak hold) 2: B-H (Bottom hold) 3: S-H (Sample hold) 4: PP-H (Peak-to-peak hold) 5: AVE-H (Average hold)
-----------------	--

## Acquiring hold conditions

Acquires the current hold conditions.

### < Command format >

H O L D M O D E C<sub>R</sub>

### < Response format >

When processing ends successfully

C<sub>R</sub>

└── Hold conditions

When processing fails

E R C<sub>R</sub>

### < Explanation of parameters >

Hold conditions	The acquired hold conditions are returned. 0: OFF 1: P-H (Peak hold) 2: B-H (Bottom hold) 3: S-H (Sample hold) 4: PP-H (Peak-to-peak hold) 5: AVE-H (Average hold)
-----------------	--

## Set/Acquire Hysteresis < HYS command >

### Setting hysteresis

Sets the hysteresis width.

#### < Command format >

H Y S       C<sub>R</sub>

Hysteresis (max. 5 digits)

#### < Response format >

When processing ends successfully

O K C<sub>R</sub>

When processing fails

E R C<sub>R</sub>

#### < Explanation of parameters >

Hysteresis	Specifies the hysteresis width. (0 to 59999) Note, however, that hysteresis can be set only by the value "HIGH threshold - LOW threshold" or less.
------------	---

### Acquiring hysteresis

Acquires the current hysteresis.

#### < Command format >

H Y S C<sub>R</sub>

#### < Response format >

When processing ends successfully

C<sub>R</sub>

Hysteresis (max. 5 digits)

When processing fails

E R C<sub>R</sub>

#### < Explanation of parameters >

Hysteresis	The acquired hysteresis is returned. (0 to 59999)
------------	---



## Acquiring HIGH/LOW thresholds

Acquires the current HIGH/LOW thresholds.

### < Command format >

- HIGH threshold

J U D P A R A 0 C<sub>R</sub>

- LOW threshold

J U D P A R A 1 C<sub>R</sub>

### < Response format >

When processing ends successfully

□ □ □ □ □ C<sub>R</sub>

Threshold (max. 6 digits)

When processing fails

E R C<sub>R</sub>

### < Explanation of parameters >

Threshold	The acquired HIGH/LOW thresholds are returned. (-19999 to 59999)
-----------	---

## Switch/Acquire Measurement Mode < MEASMODE command >

### Switching the measurement mode

Switches the current measurement mode.

#### < Command format >

MEASMODE   CR

└──┬──┘ Measurement mode

#### < Response format >

When processing ends successfully

OK CR

When processing fails

ER CR

#### < Explanation of parameters >

Measurement mode	Specifies the new measurement mode after measurement mode switching. 0: Interrupted beam width measurement mode 1: Incident beam width measurement mode 2: Outer diameter measurement mode 3: Center position measurement mode 4: IC lead pitch judgment mode 5: IC lead width judgment mode 6: Specified edge measurement mode 7: Wire position measurement mode 8: Glass edge measurement mode
------------------	---

## Acquiring the measurement mode

Acquires the current measurement mode.

### < Command format >

```
M|E|A|S|M|O|D|E|C|R
```

### < Response format >

When processing ends successfully

```
 C|R
```

└─── Measurement mode

When processing fails

```
E|R C|R
```

### < Explanation of parameters >

Measurement mode	The acquired measurement mode is returned. 0: Interrupted beam width measurement mode 1: Incident beam width measurement mode 2: Outer diameter measurement mode 3: Center position measurement mode 4: IC lead pitch judgment mode 5: IC lead width judgment mode 6: Specified edge measurement mode 7: Wire position measurement mode 8: Glass edge measurement mode
------------------	---





## Acquiring the number of IC leads

Acquires the current number of IC leads.

### < Command format >

P I N N O C<sub>R</sub>

### < Response format >

When processing ends successfully

□ □ C<sub>R</sub>

└───┘  
Number of IC leads (max. 2 digits)

When processing fails

E R C<sub>R</sub>

### < Explanation of parameters >

Number of IC leads	The acquired number of IC leads is returned. <ul style="list-style-type: none"><li>• IC lead pitch judgment mode (2 to 14)</li><li>• IC lead width judgment mode (1 to 14)</li></ul>
--------------------	--

## Set/Acquire IC Lead Pitch/IC Lead Width Standard Values < REF command >

This command is active only when the measurement mode is the IC lead pitch or IC lead width judgment mode.

### Setting standard values

Sets the IC lead pitch/IC lead width standard values.

#### < Command format >

REF         CR

Standard values (max. 6 digits)

#### < Response format >

When processing ends successfully

OK CR

When processing fails

ER CR

#### < Explanation of parameters >

Standard values	Specifies the IC lead pitch/IC lead width standard values. <ul style="list-style-type: none"><li>• IC lead pitch judgment mode (600 to 28000)</li><li>• IC lead width judgment mode (300 to 28000)</li></ul>
-----------------	--

## Acquiring the standard values

Acquires the current IC lead pitch/IC lead width standard values.

### < Command format >

R|E|F|C<sub>R</sub>

### < Response format >

When processing ends successfully

□□□□□□C<sub>R</sub>

Standard values (max. 6 digits)

When processing fails

E|R|C<sub>R</sub>

### < Explanation of parameters >

Standard values	The acquired IC lead pitch/IC lead width standard values are returned. <ul style="list-style-type: none"><li>• IC lead pitch judgment mode (600 to 28000)</li><li>• IC lead width judgment mode (300 to 28000)</li></ul>
-----------------	--

## Register Standard Received Light Intensity < TEACH command >

Registers the all incident light state as the standard received light intensity.  
No parameters are provided for this command.

### < Command format >

T|E|A|C|H|C<sub>R</sub>

### < Response format >

When processing ends successfully

O|K|C<sub>R</sub>

When processing fails

E|R|C<sub>R</sub>

## Set/Acquire IC Lead Pitch/IC Lead Width Tolerance Values < TOL command >

This command is active only when the measurement mode is the IC lead pitch or IC lead width judgment mode.

### Setting tolerance Values

Sets the IC lead pitch/IC lead width tolerance values.

#### < Command format >

T O L      C<sub>R</sub>

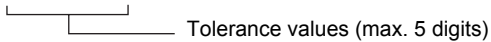
 Tolerance values (max. 5 digits)

#### < Response format >

When processing ends successfully

O K C<sub>R</sub>

When processing fails

E R C<sub>R</sub>

#### < Explanation of parameters >

Tolerance value	Specifies the IC lead pitch/IC lead width tolerance values. (0 to 28000)
-----------------	--

### Acquiring tolerance values

Acquires the current IC lead pitch/IC lead width tolerance values.

#### < Command format >

T O L C<sub>R</sub>

#### < Response format >

When processing ends successfully

C<sub>R</sub>

 Tolerance values (max. 5 digits)

When processing fails

E R C<sub>R</sub>

#### < Explanation of parameters >

Tolerance values	The acquired IC lead pitch/IC lead width tolerance values are returned. (0 to 28000)
------------------	--

# Measurement Control/Measured Value Acquisition Commands

## Acquire Number of Edges and Edge Positions < EDGEPOS command >

Acquires the current number of edges and edge positions.

### < Command format >

EDGEPOS<sup>CR</sup> or E<sup>CR</sup>

### < Response format >

When processing ends successfully

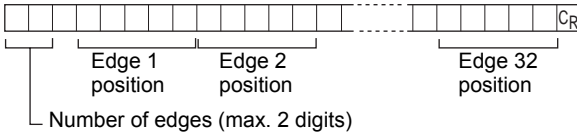

When processing fails

ER<sup>CR</sup>

### < Explanation of parameters >

Number of edges	<p>The acquired number of edges is returned as 2 bytes. (1 to 32)</p> <div style="border: 1px solid black; padding: 5px; margin: 10px 0;"> <span style="border: 1px solid black; padding: 2px;">10's digit</span>    <span style="border: 1px solid black; padding: 2px;">1's digit</span> </div> <ul style="list-style-type: none"> <li>The maximum number of edges that can be detected is 32. When this limit is exceeded, the "ER" response is returned.</li> <li>When the number of detected edges is 0, number of edges "00" is returned.</li> </ul>
Edge position	<p>The acquired edge position is returned as 5 bytes.</p> <div style="border: 1px solid black; padding: 5px; margin: 10px 0;"> <span style="border: 1px solid black; padding: 2px;">10 mm's digit</span>    <span style="border: 1px solid black; padding: 2px;">1 mm's digit</span>    <span style="border: 1px solid black; padding: 2px;">0.1 mm's digit</span>    <span style="border: 1px solid black; padding: 2px;">0.01 mm's digit</span>    <span style="border: 1px solid black; padding: 2px;">0.001 mm's digit</span> </div>

**Note****How to count edges**

Note that the edge count method differs from that in the specified edge measurement mode.



Edge count method in the specified edge measurement mode p.57

The boundary between incident light and interrupted beam sections is counted as an edge.

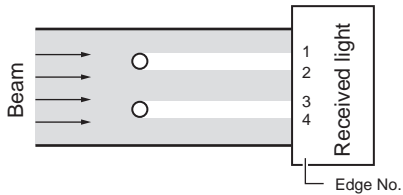

Note, however, that when the lower edge or upper edge of the beam is cut off, the lower edge or bottom edge also is counted as an edge.

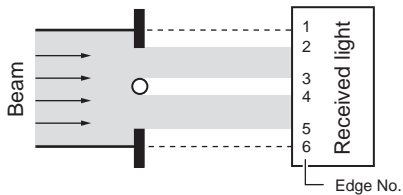

### Set/Acquire Measured Value/Judgment Result < MEASURE command >

Acquires the measured value. Judgment results are acquired by this command only when the measurement mode is the IC lead pitch or IC lead width judgment mode.

#### < Command format >

- When there is only one Controller connected

MEASURE<sup>CR</sup>

or

M<sup>CR</sup>

- When multiple Controllers are connected to each other

# [ ] [ ] MEASURE<sup>CR</sup>

or

# [ ] [ ] M<sup>CR</sup>

[ ] [ ] Channel No. (fixed at 2 digits)

[ ] [ ] Channel No. (fixed at 2 digits)



## Execute/Cancel a Zero Reset < ZERO command >

### Executing a zero reset

Executes a zero reset. No parameters are provided for this command.

#### < Command format >

Z E R O 0 C<sub>R</sub>

#### < Response format >

When processing ends successfully

O K C<sub>R</sub>

When processing fails

E R C<sub>R</sub>

### Canceling a zero reset

Cancel a zero reset. No parameters are provided for this command.

#### < Command format >

Z E R O 1 C<sub>R</sub>

#### < Response format >

When processing ends successfully

O K C<sub>R</sub>

When processing fails

E R C<sub>R</sub>



# Bank Control Command

## Switch/Acquire Bank No. < BANK command >

### Switching the bank No.

Switches the current bank No.

#### < Command format >

B A N K   C<sub>R</sub>

Bank No.

#### < Response format >

When processing ends successfully

O K C<sub>R</sub>

When processing fails

E R C<sub>R</sub>

#### < Explanation of parameters >

Bank No.	Specifies the bank No. after the bank is switched. (1, 2)
----------	---

### Acquiring the bank No.

Acquires the current bank No.

#### < Command format >

B A N K C<sub>R</sub>

#### < Response format >

When processing ends successfully

C<sub>R</sub>

Bank No.

When processing fails

E R C<sub>R</sub>

#### < Explanation of parameters >

Bank No.	The acquired bank No. is returned. (1, 2)
----------	---

# Utility Command

## Initialize Controller < DATAINIT command >

Returns all Controller setup data to their defaults. No parameters are provided for this command.

### < Command format >

```
D A T A I N I T C R
```

### < Response format >

When processing ends successfully

```
O K C R
```

When processing fails

```
E R C R
```

# APPENDICES

---

<b>Specifications and External Dimensions</b>	<b>130</b>
Sensor	130
Controller	133
Calculating Unit	135
Interface Unit	136
Extension Cable	138
<b>Error Messages and Corrective Actions</b>	<b>140</b>
Setup Errors	140
Measurement Errors	140
Standard Received Light Intensity Registration Errors	141
<b>Default Values</b>	<b>142</b>
<b>Basic Knowledge for Operation</b>	<b>143</b>
Reading Displays	143
List of Key Operations	143
<b>Laser Safety</b>	<b>144</b>
Label Replacement	144
<b>Requirements from Regulations and Standards</b>	<b>146</b>
Summary of Requirements to Manufactures	146
Summary of Requirements to User	150
Definitions of Laser Classification	153
<b>Compliance with EC Directives</b>	<b>154</b>
<b>Quick Reference for Displays</b>	<b>156</b>
<b>INDEX</b>	<b>161</b>

# Specifications and External Dimensions

## Sensor

### Specifications

Item	ZX-GT28S11	ZX-GT2840S11	ZX-GT28S41	ZX-GT2840S41
Output type	NPN type		PNP type	
Appearance	Separate type	Integrated type	Separate type	Integrated type
Emitter model	ZX-GT28E11		ZX-GT28E41	
Receiver model	ZX-GT28R			
Light source	Visible semiconductor laser diode (wavelength 650 nm, CLASS 1 of EN60825-1/IEC60825-1, CLASS II of FDA (21 CFR 1040.10 and 1040.11))			
Measuring width	28 mm			
Sensing distance	0 to 500 mm	40 mm	0 to 500 mm	40 mm
Minimum sensing object	0.5 mm dia. <sup>(*)1</sup>	0.2 mm dia.	0.5 mm dia. <sup>(*)1</sup>	0.2 mm dia.
Linearity	±0.1% F.S. <sup>(*)2</sup>			
Resolution	10 μm (number of process values to average: 16) <sup>(*)3</sup>			
Temperature characteristic	±0.01% F.S./°C <sup>(*)4</sup>			
Indicators (emitter)	Laser ON indicator (green), laser deterioration alarm indicator (red)			
Indicator (receiver)	Optical axis setting indicator (green)			
Laser OFF input/sync input	ON: Short-circuited with 0 V or 1.5 V max. OFF: Open (leakage current: 0.1 mA max.)		ON: Short-circuited with power supply voltage or power supply voltage -1.5 V max. OFF: Open (leakage current: 0.1 mA max.)	
Laser deterioration alarm output	NPN open-collector output 30 VDC 20 mA max. Residual voltage 1.2 V max.		PNP open-collector output 30 VDC 20 mA max. Residual voltage 2 V max.	
Power consumption (emitter)	30 mA max.			
Power supply voltage (emitter)	24 VDC +10%, -15% ripple (p-p) 10% max.			
Dielectric strength	1,000 VAC, 50/60 Hz for 1 min			
Insulation resistance	20 MΩ (at 500 VDC megger)			
Operating ambient illumination (emitter)	3000 lx (incandescent light)			
Operating ambient illumination (receiver)	1000 lx (incandescent light) <sup>(*)5</sup>			
Ambient temperature	Operating: 0 to +40°C Storage: -15 to +50°C (with no icing or condensation)			
Ambient humidity	Operating and storage: 35% to 85% (with no condensation)			
Vibration resistance (durability)	10 to 150 Hz Single-amplitude: 0.75 mm for 80 min each in X, Y and Z directions			
Degree of protection	IEC60529 IP40			
Cable length	2 m			
Material	Case: aluminum die-cast, Lens: glass			
Weight (packed state)	Approx. 550 g	Approx. 570 g	Approx. 550 g	Approx. 570 g
Accessories	Laser warning labels, Instruction Sheet			

F.S.: 28 mm measuring range of receiver

- \*1: Distance between emitter and receiver: 500 mm, measurement object at 250 mm from receiver  
Glass ends of chamfer 0.1 mm or more can be detected in glass edge measurement mode. (at binary level 70%)
- \*2: Linearity is given to be a typical error with respect to an ideal straight line when the distance between the emitter and receiver is 100 mm and light is blocked at a distance of 50 mm from the receiver.  
(On the ZX-GT2840\_\_, the measurement object is measured at a distance of 20 mm from the receiver.)
- \*3: The amount of fluctuation ( $\pm 3\sigma$ ) in the analog output when the distance between the emitter and receiver is 100 mm and a ZX-GTC\_\_ is connected
- \*4: Change in the light cutoff value on one side when the distance between the emitter and receiver is 100 mm and the light is half-cutoff at a distance of 50 mm from the receiver  
(On the ZX-GT2840\_\_, the measurement object is measured at a distance of 20 mm from the receiver.)
- \*5: Standard mode (NORM) used

## External Dimensions

### Separate type (emitter and receiver): ZX-GT28S11/GT28S41

#### ZX-GT28E11/GT28E41 (emitter), ZX-GT28R (receiver)

(Unit: mm)

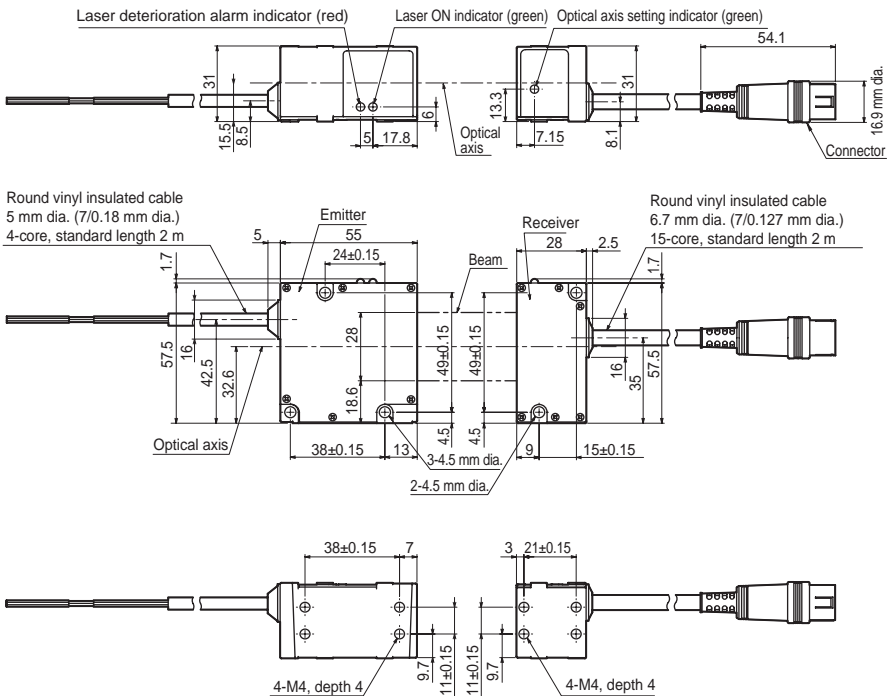

# Integrated type: ZX-GT28S11/GT28S41

(Unit: mm)

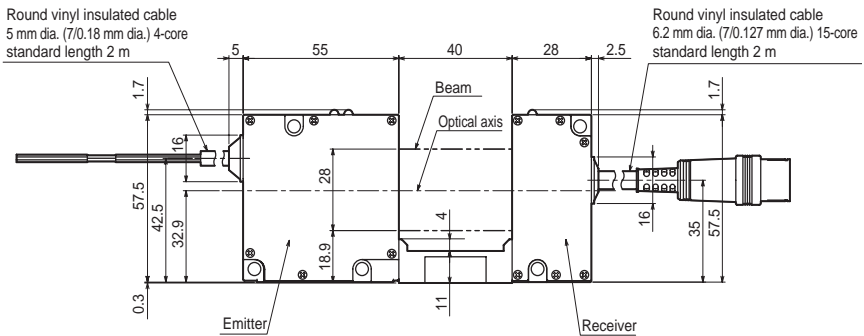
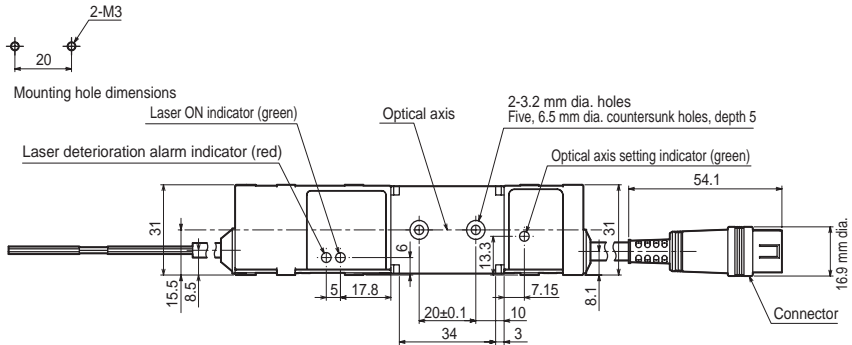

# Controller

## Specifications

Item	ZX-GTC11	ZX-GTC41
Output type	NPN type	PNP type
Compatible receiver	ZX-GT28R	
Compatible emitter	ZX-GT28E11	ZX-GT28E41
Measurement cycle <sup>(*)1</sup>	1.5ms (Standard mode (NORM)) 0.5ms (High-speed mode (FAST)) <sup>(*)2</sup>	
Number of samples to average	1/2/4/8/16/32/64/128/256/512/1024/2048/4096	
Analog output <sup>(*)3</sup>	For current output: 4 to 20mA/F.S., max. load resistance 300 Ω For voltage output: ±4V, (±5 V, 1 to 5 V <sup>(*)4</sup> ), output impedance 100 Ω	
Timing input, bank switching input, zero reset input, reset input	ON: short-circuited with 0V or 1.5V max. OFF: Open (leakage current: 0.1 mA max.)	ON: short-circuited with power supply voltage or power supply voltage -1.5V max. OFF: Open (leakage current: 0.1 mA max.)
HIGH/PASS/LOW Judgment output <sup>(*)5</sup> Sync output <sup>(*)6</sup>	NPN open-collector output 30 VDC 50 mA max. Residual voltage 1.2 V max.	PNP open-collector output 30 VDC 50 mA max. Residual voltage 2V max.
Indicator	Judgment output indicator: HIGH (orange), PASS (green), LOW (orange) Main display (red) Sub-display (yellow) Bank 1/2 (orange), zero reset (green)	
Main functions	Number of registered setups	2 banks
	Measurement Mode	Interrupted beam width measurement, incident beam width measurement, outer diameter measurement, center position measurement, IC lead pitch judgment, IC lead width judgment, specified edge measurement, wire position measurement, glass edge measurement
	Display during measurement	Measured value, resolution, threshold, voltage output value, current output value (number of display digits can be changed)
	Zero reset functions	Offset setting of zero reset value, zero reset value memory
	Hold	Sample hold, peak hold, bottom hold, peak-to-peak hold, average hold, delay hold
	Timer functions	ON delay, OFF delay, one-shot
	Adjustment functions	Optical axis adjust mode/light intensity writing mode, variable binary level, variable edge filter, analog output scaling
	Calculation	2Possible on up to two Controllers (Calculation Unit ZX-CAL2 is required for connecting Controllers to each other.) A-B, A+B, width
Other	Measurement cycle setting, threshold setting, hysteresis setting, initialization, key lock	
Temperature characteristic	±0.005%F.S./°C	
Current consumption	150 mA max. (including receiver)	
Power supply voltage	24 VDC +10%, -15% ripple (p-p) 10% max.	
Dielectric strength	1,000 VAC, 50/60 Hz for 1 min	
Insulation resistance	20 MΩ (at 500 VDC megger)	

Item	ZX-GTC11	ZX-GTC41
Ambient temperature	Operating: 0 to +50°C Storage: -15 to +60°C (with no icing or condensation)	
Ambient humidity	Operating and storage: 35% to 85% (with no condensation)	
Vibration resistance (durability)	10 to 150 Hz Single-amplitude: 0.35 mm for 80 min each in X, Y and Z directions	
Degree of protection	IEC60529 IP20	
Cable length	2 m	
Material	Case: PBT (polybutylene terephthalate), Cover: Polycarbonate	
Weight (packed state)	Approx. 330 g	
Accessories	Instruction Sheet	

- \*1: A simple average is used in IC lead pitch judgment mode or IC lead width judgment mode. The measurement cycle time can be calculated as follows: Specified measurement cycle time x (Number of samples to average + 1) + 1 ms max. In other measurement modes, a moving average is used. The first measurement cycle time can be calculated as follows: Specified measurement cycle time x (Number of samples to average + 1) + 1 ms max. The second and later measurement cycle times will be equal to the specified measurement cycle time.
- \*2: The response time in the high-speed mode (FAST) for the IC lead pitch and IC lead width judgment modes is 1 ms.
- \*3: Current/voltage can be switched using the switch provided on the rear of the Controller.
- \*4: Can be set by the analog output scaling function.
- \*5: The error (ERR) state is displayed when all HIGH/PASS/LOW outputs turn OFF.
- \*6: Normally, wire the sync output wire directly to the emitter's sync input wire and run the Controller in the standard mode.  
On an NPN type Controller, use an NPN type emitter, and on a PNP type Controller, use a PNP type emitter. Wiring of the sync wires is not required when the Controller is run in the high-speed mode. (Note, however, that the Controller becomes more susceptible to the influence of ambient light in this case.)

## External Dimensions

### ZX-GTC11/GTC41

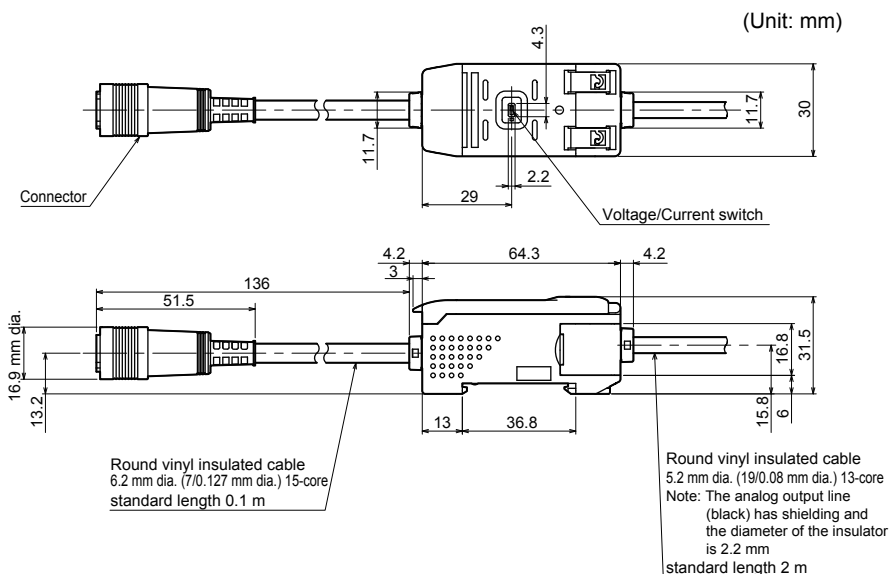



# Calculating Unit

## Specifications

Item	ZX-CAL2
Compatible Controller	ZX series
Current consumption	12 mA max. (supplied from the Controller)
Connection method	Connector
Dielectric strength	1,000 VAC, 50/60 Hz for 1 min
Insulation resistance	100 M $\Omega$ (at 500 VDC megger)
Ambient temperature	Operating: 0 to +50°C Storage: -15 to +60°C (with no icing or condensation)
Ambient humidity	Operating and storage: 35% to 85% (with no condensation)
Vibration resistance (durability)	10 to 150 Hz Double-amplitude: 0.7 mm for 80 min each in X, Y and Z directions
Shock resistance (destructive)	300 m/s <sup>2</sup> 3 times each in 6 directions (up/down, left/right, forward/backward)
Material	Display: Acrylic, Case: ABS resin
Weight (packed state)	Approx. 50 g

## External Dimensions

### ZX-CAL2

(Unit: mm)

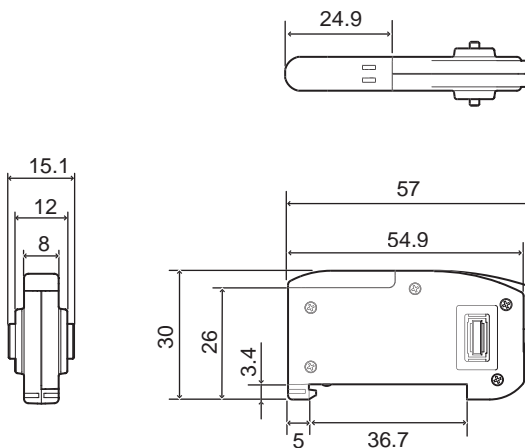

# Interface Unit

## Specifications

Item	ZX-GIF11A	ZX-GIF11	ZX-GIF41A	ZX-GIF41
Compatible Controller	ZX-GTC11		ZX-GTC41	
Indicator	Power ON (green), Controller communications (orange), Controller communications error (red), RS-232C communications (orange), RS-232C communications error (red), binary output (orange)			
Communications port	RS-232C (9-pin D-sub connector)			
12-bit binary output (D11 to D0, GATE)	NPN open-collector output 30 VDC 20mA max. Residual voltage 1.2 V max.		PNP open-collector output 30 VDC 20 mA max. Residual voltage 2 V max.	
Power supply voltage	Supplied from Controller (power consumption: 60 mA max.)			
Dielectric strength	1,000 VAC, 50/60 Hz for 1 min			
Insulation resistance	20 M $\Omega$ (at 500 VDC megger)			
Ambient temperature	Operating: 0 to +50°C Storage: -15 to +60°C (with no icing or condensation)			
Ambient humidity	Operating and storage: 35 to 85% (with no condensation)			
Vibration resistance (durability)	10 to 150 Hz Single-amplitude: 0.35 mm for 80 min each in X, Y and Z directions			
Degree of protection	IEC60529 IP20			
Cable length	RS-232C 0.5 m, binary output 2 m			
Material	Case: PBT (polybutylene terephthalate), Cover: Polycarbonate			
Weight (packed state)	Approx. 550 g	Approx. 330 g	Approx. 550 g	Approx. 330 g
Accessories	ZX-GIF_1 A : Setup Software (CD-ROM), 2 clamps, Instruction Sheet ZX-GIF_1 : 2 clamps, Instruction Sheet			

## External Dimensions

### ZX-GIF11/GIF41

(Unit: mm)

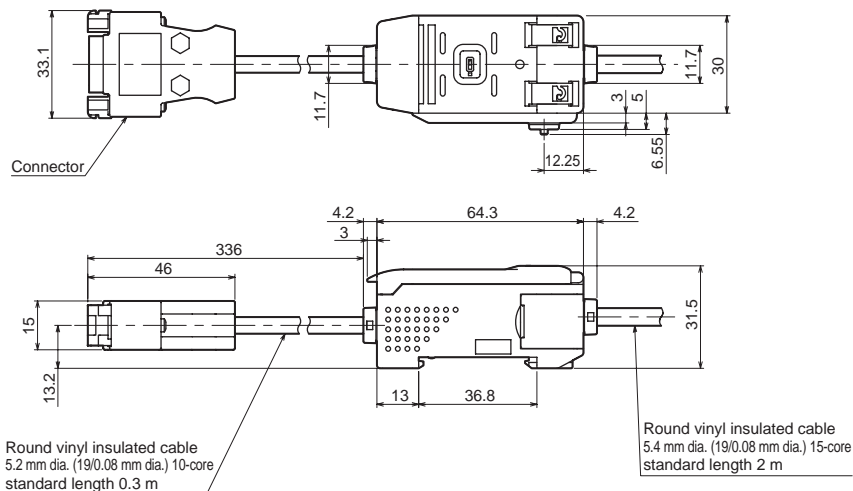

# Extension Cable

## Specifications

Item	Standard cable	ZX-XGC1A	ZX-XGC2A	ZX-XGC5A	ZX-XGC8A	ZX-XGC20A
	Flexible cable	ZX-XGC1R	ZX-XGC2R	ZX-XGC5R	ZX-XGC8R	ZX-XGC20R
Cable length		1 m	2 m	5 m	8 m	20 m
Applicable Sensor	ZX-GT series					
Applicable Controller	ZX-GT series					

## External Dimensions

ZX-XGC\_A/XGC\_R

(Unit: mm)

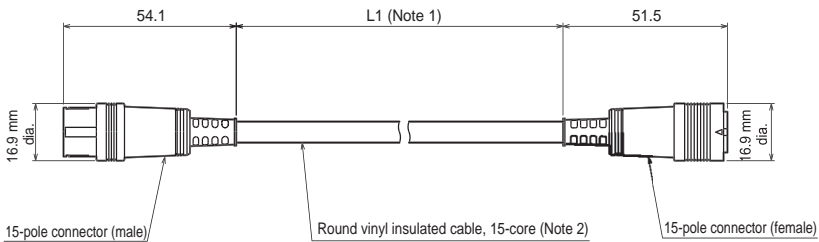

Note 1: ZX-XGC1A/R: 1M  
 ZX-XGC2A/R: 2M  
 ZX-XGC5A/R: 5M  
 ZX-XGC8A/R: 8M  
 ZX-XGC20A/R: 20M

Note 2: Standard cable: 6.2 mm dia.  
 Flexible cable: 6.1 mm dia.

## Signal I/O States

### Input specifications

Input specifications	RUN mode	T mode	FUN mode
Bank switching input	Enabled	Enabled	Disabled
Zero reset input	Enabled	Disabled	Disabled
Timing input	Enabled	Enabled (↑ UP key disabled)	Disabled
Reset Input	Enabled	Enabled (↓ DOWN key disabled)	Disabled
Laser OFF input (emitter signal)	Enabled	Enabled	Enabled

### Output specifications

	RUN mode		T mode	FUN mode
	Regular	After a reset		
Analog output	Measured value (*1)	Max. value (*2)	KEEP (The output in the RUN mode is kept. The max. value is used when the power supply is started up.)	KEEP (The output in the RUN mode is kept. The max. value is used when the power supply is started up.)
HIGH/PASS/LOW output	Judgment	OFF	KEEP (The output in the RUN mode is kept.)	KEEP (The output in the RUN mode is kept.)
Binary output (IFU)	Measured value	OFF	KEEP (The output in the RUN mode is kept.)	KEEP (The output in the RUN mode is kept.)
GATE (IFU)	ON/OFF	OFF	OFF	OFF

\*1: These are not measured values in the IC lead pitch and IC lead width judgment modes. Voltage output: 0 V, current output: 4 mA

\*2: Max. value: at voltage output, approx. 5.5 V, at current output, approx. 23 mA

# Error Messages and Corrective Actions

The following shows error messages that are displayed on the main display and their corrective actions.

## Setup Errors

Error message	Probable cause and possible countermeasure	Reference
ERRLH	The setting is "LOW threshold > HIGH threshold - hysteresis". <ul style="list-style-type: none"><li>• Enter the LOW threshold so that "LOW threshold &lt; HIGH threshold - hysteresis".</li></ul>	p.45
ERRHL	The setting is "HIGH threshold < LOW threshold + hysteresis". <ul style="list-style-type: none"><li>• Enter the HIGH threshold so that "HIGH threshold &gt; LOW threshold - hysteresis".</li></ul>	p.45
ERROV	The set numeric value is too large. <ul style="list-style-type: none"><li>• Enter an appropriate numeric value.</li></ul>	-
	The setting is "hysteresis > HIGH threshold - LOW threshold". <ul style="list-style-type: none"><li>• Enter the hysteresis so that "hysteresis &lt; HIGH threshold - LOW threshold".</li></ul>	p.67
ERRUD	The set numeric value is too small. <ul style="list-style-type: none"><li>• Enter an appropriate numeric value.</li></ul>	-

## Measurement Errors

Error message	Probable cause and possible countermeasure	Reference
E-CHL	There are two Sensors but only one Controller connected. <ul style="list-style-type: none"><li>• If two or more Controllers are connected to each other, turn OFF the power supply and check that the Controllers and Calculating Units are connected correctly.</li><li>• If only one Controller is being used, connect two or more Controllers temporarily and turn OFF two-Sensor operation, or initialize the settings data.</li></ul>	p.37 p.39 p.59
E-DAT	Two-Sensor operation communications data error <ul style="list-style-type: none"><li>• Change the mode for the CH1 Controller to RUN.</li><li>• Turn OFF the power supply and check that the Controller and Calculating Units are connected correctly. Replace the Controller or the Calculating Unit if the above countermeasures do not solve the problem.</li><li>• When the SmartMonitor GT is in use, the two-Sensor operation error occurs while the CH1 graph is displayed or during logging.</li></ul>	p.22 p.37
E-HED	The Sensor is disconnected. <ul style="list-style-type: none"><li>• Turn OFF the power supply, check the connection for the Sensor, and then turn ON the power supply again. Replace the Sensor if the above countermeasure does not solve the problem.</li></ul>	p.28

Error message	Probable cause and possible countermeasure	Reference
E-SHT	One or all of the judgment outputs are short-circuited. <ul style="list-style-type: none"> <li>• Turn OFF the power supply, check that the HIGH, PASS, and LOW output lines are not short-circuited, then turn ON the power supply again.</li> </ul>	p.30
E-WID	The numerical value width of the width setting is not set. <ul style="list-style-type: none"> <li>• Enter an appropriate width.</li> </ul>	p.59
E-EEP	Setting data is in error. <ul style="list-style-type: none"> <li>• Hold the ENT key down for at least 3 seconds to initialize the settings data.</li> <li>• Replace the Controller if the above countermeasure does not solve the problem.</li> </ul>	p.39

## Standard Received Light Intensity Registration Errors

The following messages are displayed if correct received light intensity data cannot be obtained. Remedy the error and register the standard received light intensity again.

Error message	Probable cause and possible countermeasure	Reference
ERR1	Excessive ambient light error <ul style="list-style-type: none"> <li>• Prevent ambient light from entering the receiver, for example, by repositioning the receiver or by installing a light baffle.</li> </ul>	p.25
ERR2	Dirty emitter surface/object blocking light path <ul style="list-style-type: none"> <li>• Wipe the optical filter of the emitter and receiver with a soft cloth (for cleaning lenses). Also, remove the object blocking the light path.</li> </ul>	-
DRK1	Insufficient received light intensity <ul style="list-style-type: none"> <li>• Re-adjust the optical axis.</li> </ul>	p.42
DRK2	Dirty emitter surface/object blocking light path <ul style="list-style-type: none"> <li>• Wipe the optical filter of the emitter and receiver with a soft cloth (for cleaning lenses). Also, remove the object blocking the light path.</li> </ul>	-
HIER	Receiver mount shifting upwards <ul style="list-style-type: none"> <li>• Install the emitter at a higher position.</li> </ul>	p.25
LOER	Receiver mount shifting downwards <ul style="list-style-type: none"> <li>• Install the emitter at a lower position.</li> </ul>	p.25

# Default Values

The following table summarizes the default values of this Controller.

Function	Default Value
Measurement cycle	Standard mode (NORM)
Measurement mode	Interrupted beam width measurement
Averaging number	16
Hysteresis	00.100
Hold	OFF
Judgment output timing (timer)	OFF
Special functions	CLOSE
Zero reset memory	OFF
Zero reset	00.000
Display reverse	OFF
ECO mode	OFF
Number of display digits	5 digits
Output scaling	Voltage Measured value 0 mm: -4 V Measured value 28 mm: 4 V
Baud rate	38400
Data length	8
Stop bit	1
Parity	None
Header/footer selection	CR
Binary output cycle (ms)	1
Binary level (%)	25
Edge filter	7
Bank switching setting	Control key operation
Bank	1
HIGH threshold	20.000
LOW threshold	10.000



# Basic Knowledge for Operation

## Reading Displays





The data displayed on the main and sub-displays differs according to the currently selected mode.

Alphabet Display Format

A	B	C	D	E	F	G	H	I	J	K	L	M
ᠠ	ᠡ	ᠢ	ᠣ	ᠤ	ᠥ	ᠦ	ᠨ	ᠬ	ᠵ	ᠶ	ᠷ	ᠮ
N	O	P	Q	R	S	T	U	V	W	X	Y	Z
ᠨ	ᠣ	ᠮ	ᠵ	ᠷ	ᠶ	ᠬ	ᠵ	ᠶ	ᠷ	ᠮ	ᠵ	ᠷ

## List of Key Operations

The functions of keys differ according to the currently selected mode.

Key		Description		
		FUN mode	TEACH mode	RUN mode
←LEFT key		The function changes depending on the settings.	Selects the digit of numerical values.	Changes the sub-display content.
→RIGHT key		<ul style="list-style-type: none"> <li>Switches the function display.</li> <li>Selects the digit of numerical values.</li> <li>Stops setting.</li> </ul>		
↑UP key		The function changes depending on the settings.	Changes numerical values.	Timing input
↓DOWN key		<ul style="list-style-type: none"> <li>Switches between selections.</li> <li>Changes numerical values.</li> </ul>		Hold down for at least 3 seconds for reset input.
ENT key		Applies the item you are setting up.		Executes a zero reset. When held down together with the → right key for at least three seconds, cancels a zero reset.

# Laser Safety

Various safety standards regarding laser products are stipulated depending on the country of use.

Take safety measures according to each standard.

## Classification

Standards and classification (*1)		Maximum output of laser beam
JIS C 6802 2011 (Japan) EN60825/IEC60825-1 (Europe)	FDA (the United States)	
Class 1	Class 2	Max. output 0.2 mW

\*1 For products exported to the countries other than Japan and Europe, different safety standards are applied according to the countries. Check the LED safety regulations and standards of the relevant country.

## Label Replacement

The warning label written in Japanese is affixed to the Sensor unit. For countries other than Japan, warning labels must be replaced by English ones (supplied with the Sensor).

### ● Use in the United States

When exporting devices in which this product is installed to the U.S., the devices are subjected to the U.S. FDA (Food and Drug Administration) laser regulations, and is classified as Class II specified by the U.S. FDA.

This product has already been registered with the CDRH (Center for Devices and Radiological Health).

Labels in compliance with FDA laser regulations are attached to devices subjected to these regulations. When exporting devices to the U.S., replace the labels on the Sensor body referring to the figure below. Attach the labels at the correct positions marked in the following figure.

These labels also show that the device will be installed in the end system. Follow the following technical standards when installing the device in the end system.

\* FDA standards: 21 CFR 1040.10 and 1040.11

Technical standards relating to "Laser products" and "Specific purpose laser products"

For details, consult us separately.

FDA/certification label

This Laser Product complies with  
21 CFR 1040.10 and 1040.11.  
OMRON Corporation  
Shiohaji Horikawa, Shimogyo-ku,  
Kyoto 600-8530 JAPAN  
Place of manufacture:  
AYABE Factory, OMRON Corp.  
Manufactured in

FDA/laser emission port label

**AVOID  
EXPOSURE**  
Laser radiation  
is emitted from  
this aperture

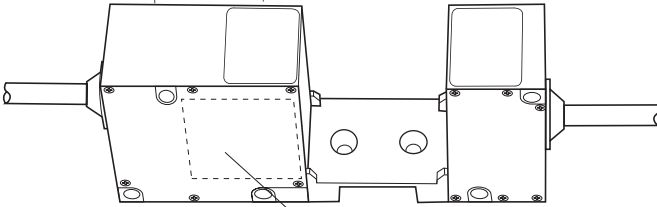

FDA/Caution label

**CAUTION**

LASER RADIATION  
DO NOT STARE INTO BEAM

PEAK POWER 200 μW  
PULSE DURATION 10 μs  
WAVE LENGTH 650 nm  
CLASS II LASER PRODUCT

● Use in Countries Other than the U.S.

For countries other than Japan and U.S., explanatory labels must be replaced by English ones (supplied with the product). When exporting to Europe, regulations differ as they must comply with EN60825.



# Requirements from Regulations and Standards

## Summary of Requirements to Manufactures

### For Europe

EN 60825-1 “Safety of Laser Products, Equipment Classification, Requirements and User’s Guide”  
Summary of Manufacturer’s Requirements

Requirements subclause	Classification						
	Class 1	Class 1M	Class 2	Class 2M	Class 3R	Class 3B	Class 4
Description of hazard class	Safe under reasonably foreseeable conditions	As for Class 1 except may be hazardous if user employs optics	Low power; eye protection normally afforded by aversion responses	As for Class 2 except may be more hazardous if user employs optics	Direct intrabeam viewing may be hazardous	Direct intrabeam viewing normally hazardous	High power; diffuse reflections may be hazardous
Protective housing		Required for each laser product; limits access necessary for performance of functions of the products					
Safety interlock in protective housing	Designed to prevent removal of the panel until accessible emission values are below that for Class 3R				Designed to prevent removal of the panel until accessible emission values are below that for Class 3B		
Remote control	Not required					Permits easy addition of external interlock in laser installation	
Key control	Not required					Laser inoperative when key is removed	
Emission warning device	Not required				Give audible or visible warning when laser is switched on or if capacitor bank of pulsed laser is being charged. For Class 3R only, applies invisible radiation is emitted		
Attenuator	Not required					Give means beside the On/Off switch to temporarily to block beam	
Location controls	Not required				Controls so located that there is no danger of exposure to AEL above Classes 1 or 2 when adjustments are made		
Viewing optics	Not required	Emission from all viewing systems must be below Class 1M AEL					
Scanning	Scan failure shall not cause product to exceed its classification						
Class label	Required wording		Figures A required wording				
Aperture label	Not required				Specified wording required		
Service entry label	Required as appropriate to the class of accessible radiation						
Override interlock label	Required under certain conditions as appropriate to the class of laser used						
Wavelength range label	Required for certain wavelength ranges						
LED label	Make required word substitutions for LED products						
User information	Operation manuals must contain instructions for safe use. Additional requirement apply for Class 1M and Class 2M						
Purchasing and service information	Promotion brochures must specify product classification; service manuals must contain safety information						

- Note:**
1. This table is intended to provide a convenient summary of requirements. See text of this standard for complete requirements.
  2. For the safety medical laser products, IEC 60601-2-22 applies
  3. AEL: Accessible Emission Limit  
The maximum accessible emission level permitted within a particular class. For your reference, see ANSI Z136.1-1993, Section 2.

Symbol and border: black  
Background: yellow

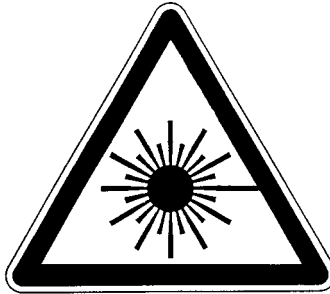

**Figure A Warning label - Hazard symbol**

Legend and border: black  
Background: yellow



**Figure B Explanatory label**

## For U. S. A

FDA (Compliance Guide for Laser Products, 1985, according to 21 CFR1040.10)

Requirements	Class (see note 1)					
	I	Ila	II	IIla	IIlb	IV
Performance (all laser products)						
Protective housing	R (see note 2)	R (see note 2)	R (see note 2)	R (see note 2)	R (see note 2)	R (see note 2)
Safety interlock	R (see notes 3,4)	R (see notes 3,4)	R (see notes 3,4)	R (see notes 3,4)	R (see notes 3,4)	R (see notes 3,4)
Location of controls	N/A	R	R		R	R
Viewing optics	R	R	R	R	R	R
Scanning safeguard	R	R	R	R	R	R
Performance (laser systems)						
Remote control connector	N/A	N/A	N/A	N/A	R	R
Key control	N/A	N/A	N/A	N/A	R	R
Emission indicator	N/A	N/A	R	R	R (see note 10)	R (see note 10)
Beam attenuator	N/A	N/A	R	R	R	R
Reset	N/A	N/A	N/A	N/A	N/A	R (see note 13)
Performance (specific purpose products)						
Medical	S	S	S	S (see note 8)	S (see note 8)	S (see note 8)
Surveying, leveling, alignment	S	S	S	S	NP	NP
Demonstration	S	S	S	S	S (see note 11)	S (see note 11)
Labeling (all laser products)						
Certification & identification	R	R	R	R	R	R
Protective housing	D (see note 5)	D (see note 5)	D (see note 5)	D (see note 5)	D (see note 5)	D (see note 5)
Aperture	N/A	N/A	R	R	R	R
Class warning	N/A	R (see note 6)	R (see note 7)	R (see note 9)	R (see note 12)	R (see note 12)
Information (all laser products)						
User information	R	R	R	R	R	R
Product literature	N/A	R	R	R	R	R
Service information	R	R	R	R	R	R

**Abbreviations:**

- R:** Required.  
**N/A:** Not applicable.  
**S:** Requirements: Same as for other products of that Class. Also see footnotes.  
**NP:** Not permitted.  
**D:** Depends on level of interior radiation.

**Footnotes:**

- Note 1:** Based on highest level accessible during operation.  
**Note 2:** Required wherever & whenever human access to laser radiation above Class I limits is not needed for product to perform its function.  
**Note 3:** Required for protective housings opened during operation or maintenance, if human access thus gained is not always necessary when housing is open.  
**Note 4:** Interlock requirements vary according to Class of internal radiation.  
**Note 5:** Wording depends on level & wavelength of laser radiation within protective housing.  
**Note 6:** Warning statement label.  
**Note 7:** CAUTION logotype.  
**Note 8:** Requires means to measure level of laser radiation intended to irradiate the body.  
**Note 9:** CAUTION if  $2.5 \text{ mW cm}^{-2}$  or less, DANGER if greater than  $2.5 \text{ mW cm}^{-2}$ .  
**Note 10:** Delay required between indication & emission.  
**Note 11:** Variance required for Class IIb or IV demonstration laser products and light shows.  
**Note 12:** DANGER logotype.  
**Note 13:** Required after August 20, 1986.

# Summary of Requirements to User

## For Europe

EN 60825-1

Requirements subclause	Classification						
	Class 1	Class 1M	Class 2	Class 2M	Class 3R	Class 3B	Class 4
Laser safety officer	Not required but recommended for applications that involve direct viewing of the laser beam				Not required for visible emission Required for non-visible emission	Required	
Remote interlock	Not required					Connect to room or door circuits	
Key control	Not required					Remove key when not in use	
Beam attenuator	Not required					When in use prevents inadvertent exposure	
Emission indicator device	Not required				Indicates laser is energized for non-visible wavelengths	Indicates laser is energized	
Warning signs	Not required					Follow precautions on warning signs	
Beam path	Not required	Class 1M as for Class 3B (see note 2)	Not required	Class 2M as for Class 3B (see note 3)	Terminate beam at end of useful length		
Specular reflection	No requirements	Class 1M as for Class 3B (see note 2)	No requirements	Class 2M as for Class 3B (see note 3)	Prevent unintentional reflections		
Eye protection	No requirements				Not required for visible emission Required for non-visible emission	Required if engineering and administrative procedures not practicable and MPE exceeded	
Protective clothing	No requirements					Sometimes required	Specific requirements
Training	No requirements	Class 1M as for Class 3R (see note 2)	No requirements	Class 2M as for Class 3R (see note 3)	Required for all operator and maintenance personnel		

- Note:**
1. This table is intended to provide a convenient summary of requirements. See text of this standard for complete precautions.
  2. Class 1M laser products that failed condition 1 of table 10 of the standard. Not required for Class 1M laser products that failed condition 2 of table 10 of the standard. See the text for details.
  3. Class 2M laser products that failed condition 1 of table 10 of the standard. Not required for Class 2M laser products that failed condition 2 of table 10 of the standard. See the text for details.



## For U. S. A

### ANSI Z136.1:1993 “American National Standard for the Safe Use of Lasers” Control Measures for the Four Laser Classes

Control measures	Classification					
	1	2a	2	3a	3b	4
Engineering Controls	1	2a	2	3a	3b	4
Protective Housing (4.3.1)	X	X	X	X	X	X
Without Protective Housing (4.3.1.1)	LSO (see note 2) shall establish Alternate Controls					
Interlocks on Protective Housing (4.3.2)	☆	☆	☆	☆	X	X
Service Access Panel (4.3.3)	☆	☆	☆	☆	X	X
Key Control (4.3.4)	---	---	---	---	•	X
Viewing Portals (4.3.5.1)	---	---	MPE	MPE	MPE	MPE
Collecting Optics (4.3.5.2)	MPE	MPE	MPE	MPE	MPE	MPE
Totally Open Beam Path (4.3.6.1)	---	---	---	---	X NHZ	X NHZ
Limited Open Beam Path (4.3.6.2)	---	---	---	---	X NHZ	X NHZ
Enclosed Beam Path (4.3.6.3)	None is required if 4.3.1 and 4.3.2 fulfilled					
Remote Interlock Connector (4.3.7)	---	---	---	---	•	X
Beam Stop or Attenuator (4.3.8)	---	---	---	---	•	X
Activation Warning Systems (4.3.9)	---	---	---	---	•	X
Emission Delay (4.3.9.1)	---	---	---	---	---	X
Indoor Laser Controlled Area (4.3.10)	---	---	---	---	X NHZ	X NHZ
Class 3b Laser Controlled Area (4.3.10.1)	---	---	---	---	X	---
Class 4 Laser Controlled Area (4.3.10.2)	---	---	---	---	---	X
Laser Outdoor Controls (4.3.11)	---	---	---	---	X NHZ	X NHZ
Laser in Navigable Airspace (4.3.11.2)	---	---	---	•	•	•
Temporary Laser Controlled Area (4.3.12)	☆ MPE	☆ MPE	☆ MPE	☆ MPE	---	---
Remote Firing & Monitoring (4.3.13)	---	---	---	---	---	•
Labels (4.3.14 and 4.7)	X	X	X	X	X	X
Area Posting (4.3.15)	---	---	---	•	X NHZ	X NHZ
Administrative & Procedural Controls	1	2a	2	3a	3b	4

Control measures	Classification					
Standard Operating Procedures (4.4.1)	---	---	---	---	•	X
Output Emission Limitations (4.4.2)	---	---	---	LSO Determination		
Education and Training (4.4.3)	---	---	•	•	X	X
Authorized Personnel (4.4.4)	---	---	---	---	X	X
Alignment Procedures (4.4.5)	---	---	X	X	X	X
Protective Equipment (4.4.6)	---	---	---	---	•	X
Spectator (4.4.7)	---	---	---	---	•	X
Service Personnel (4.4.8)	☆ MPE	☆ MPE	☆ MPE	☆ MPE	X	X
Demonstration with General Public (4.5.1)	MPE+	---	X	X	X	X
Laser Optical Fiber Systems (4.5.2)	MPE	MPE	MPE	MPE	X	X
Laser Robotic Installations (4.5.3)	---	---	---	---	X NHZ	X NHZ
Eye Protection (4.6.2)	---	---	---	---	• MPE	X MPE
Protective Windows (4.6.3)	---	---	---	---	X NHZ	X NHZ
Protective Barriers and Curtains (4.6.4)	---	---	---	---	•	•
Skin Protection (4.6.5)	---	---	---	---	X MPE	X MPE
Other Protective Equipment (4.6.5)	Use may be required					
Warning Signs and Labels (4.7) (Design Requirements)	---	---	•	•	X NHZ	X NHZ
Service and Repairs (4.8)	LSO Determination					
Modification of Laser Systems (4.9)	LSO Determination					

**Note:** 1. LEGEND

- X: Shall
- : Should
- : No requirement
- ☆: Shall if enclosed Class 3b or Class 4
- MPE: Shall if MPE is exceeded
- NHZ: Nominal Hazard Zone analysis required
- +: Applicable only to UV and IR Lasers (4.5.1.2)

2. LSO: Laser Safety Officer

An individual shall be designated the Laser Safety Officer with the authority and responsibility to monitor and enforce the control of laser hazards, and to effect the knowledgeable evaluation and control of laser hazards.

For your reference, see ANSI Z136.1993, Section 1.3.

# Definitions of Laser Classification

## For Europe

### Laser Product Classifications

EN

Class	Description
Class 1	Safe under reasonably foreseeable conditions
Class 1M	As for Class 1 except may be hazardous if user employs optics
Class 2	Low power; eye protection normally afforded by aversion responses
Class 2M	As for Class 2 except may be more hazardous if user employs optics
Class 3R	Direct intrabeam viewing may be hazardous
Class 3B	Direct intrabeam viewing normally hazardous
Class 4	High power; diffuse reflections may be hazardous

**Note:** Conditions for safe viewing of diffuse reflections for Class 3B visible lasers are: minimum viewing distance of 13 cm between screen and cornea and a maximum viewing time of 10 s. Other viewing conditions require a comparison of the diffuse reflection exposure with the MPE.

## For U. S. A

### Comparison of Classifications between FDA and ANSI

Class	FDA definition	ANSI description
Class I/1	Limits applicable to devices that have emissions in the ultraviolet, visible, and infrared spectra, and limits below which biological hazards have not been established.	A Class 1 laser is considered to be incapable of producing damaging radiation levels during operation and maintenance and is, therefore, exempt from any control measures or other forms of surveillance.
Class IIa/2a	Limits applicable to products whose visible emission does not exceed Class I limits for emission durations of 1,000 seconds or less and are not intended for viewing.	Class 2 lasers are divided into two subclasses, 2 and 2a. A Class 2 laser emits in the visible portion of the spectrum (0.4 to 0.7 $\mu\text{m}$ ) and eye protection is normally afforded by the aversion response including the blink reflex.
Class II/2	Limits applicable to products that have emissions in the visible spectrum (400 to 710 nm) for emission durations in excess of 0.25 second, providing that emissions for other durations and/or wavelengths do not exceed the Class I limits. Class II products are considered hazardous for direct long-term ocular exposure.	
Class IIIa/3a	Limits to products that have emissions in the visible spectrum and that have beams where the total collectable radiant power does not exceed 5 milliwatts.	Class 3 lasers are divided into two subclasses, 3a and 3b. A Class 3 laser may be hazardous under direct and specular reflection viewing conditions, but the diffuse reflection is usually not a hazard.
Class IIIb/3b	Limits applicable to devices that emit in the ultraviolet, visible, and infrared spectra. Class IIIb products include laser systems ranging from 5 to 500 milliwatts in the visible spectrum. Class IIIb emission levels are ocular hazards for direct exposure throughout the range of the Class, and skin hazards at the higher levels of the Class.	
Class IV/4	Exceeding the limits of Class IIIb and are a hazard for scattered reflection as well as for direct exposure.	A Class 4 laser is a hazard to the eye or skin from the direct beam and sometimes from a diffuse reflection and also can be a fire hazard. Class 4 lasers may also produce laser-generated air contaminants and hazardous plasma radiation.

# Compliance with EC Directives

CE marking	Applicable directive		Safety category
	Low-Voltage directive	EMC directive	
Compliance	Exception	Compliance	B

MEMO

# Quick Reference for Displays

## FUN mode

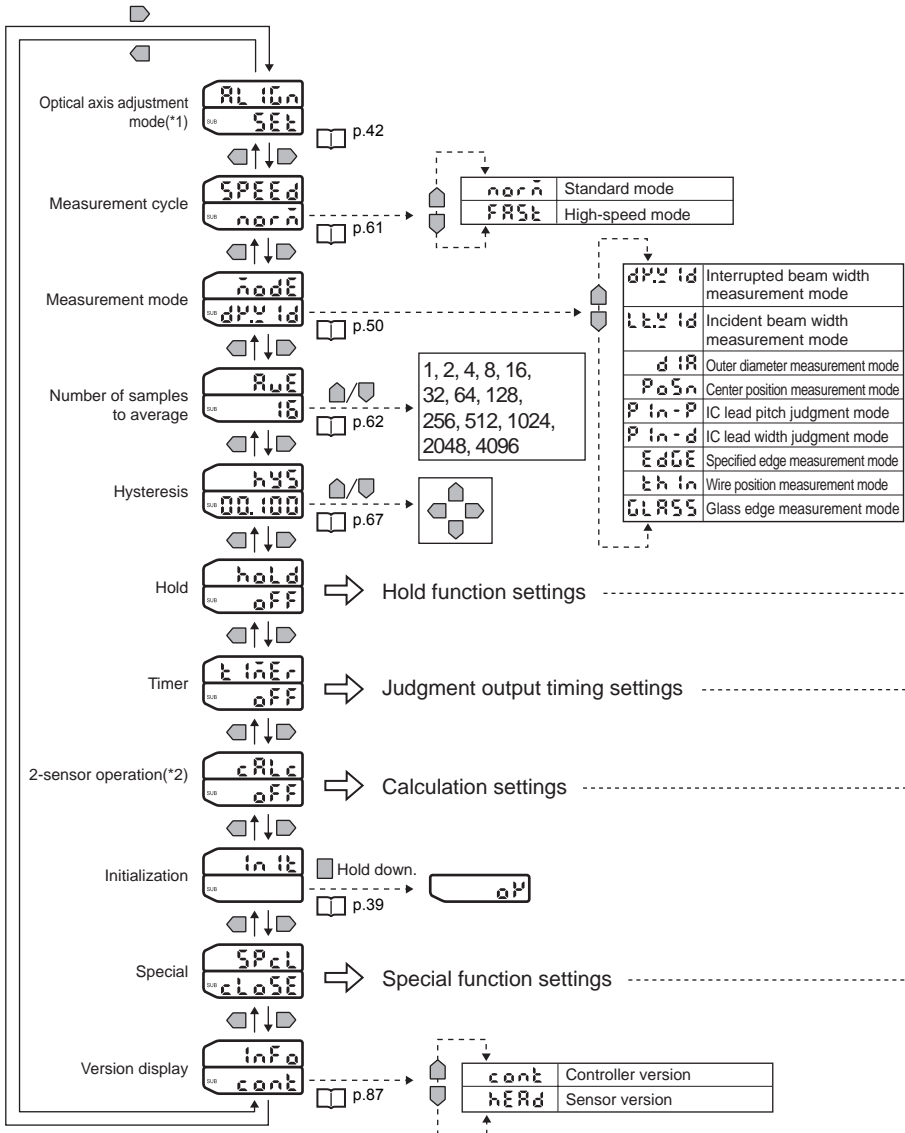

■ Hold function settings p.73

OFF	Hold OFF
Ave-h	Average hold
PP-h	Peak-to-peak hold
SAMPLE	Sample hold
b-h	Bottom hold
P-h	Peak hold

Delay hold

Delay time

Sampling period

■ Judgment output timing settings p.65

OFF	Timer OFF
1-Shot	One-shot
ON-d	ON delay
OFF-d	OFF delay

Timer setting

■ Calculation settings p.59

OFF	Calculation OFF
Width	Width calculation mode
A+B	A+B mode
A-B	A-B mode

Width calculation mode

■ Special function settings

CLoSE	Function OFF
RLL	Display all
Exc	Zero reset
dISP	Display settings
IFW	Communications settings
ScL	Scaling settings
n-Lw	Filter settings
BRoP	Bank settings

- \*1: When the mode is switched to the FUN mode, the optical axis adjustment mode will be displayed first.
- \*2: When two or more Controllers are connected to each other, this is displayed on the Controller whose channel No. is not CH1.

This symbol requests you to move to another menu using the ← LEFT key or → RIGHT key after pressing the ENT Key to confirm the selections.

These symbols indicate changes to numerical values using the ← LEFT key or → RIGHT key, and movement between the digits by the ↑ UP key or ↓ DOWN key.

● When [ETC] is selected:

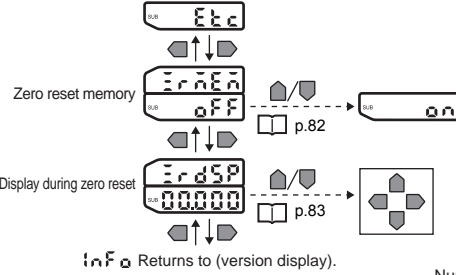

● When [DISP] is selected:

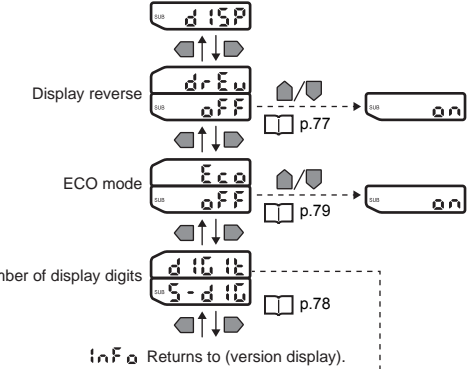

● When [IFU] is selected:

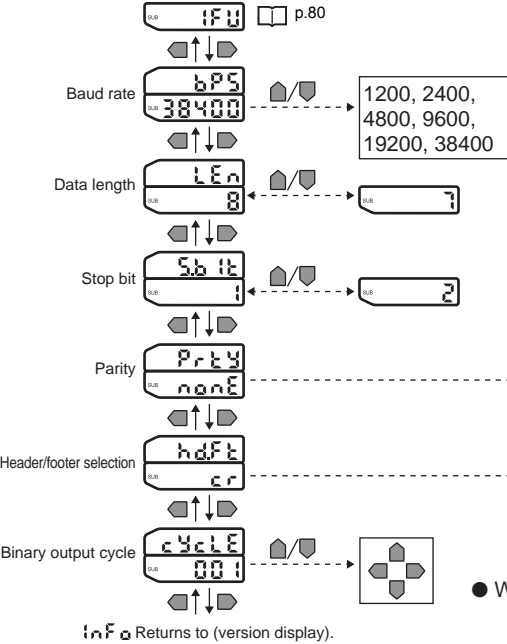

5-d 10	5-digit display
4-d 10	4-digit display
3-d 10	3-digit display
2-d 10	2-digit display
1-d 10	1-digit display
0-d 10	Display OFF

  

none	None
odd	Odd
even	Even

cr	CR
stx+etx	STX+ETX
cr+lf	CR+LF

● When [OUT] is selected:



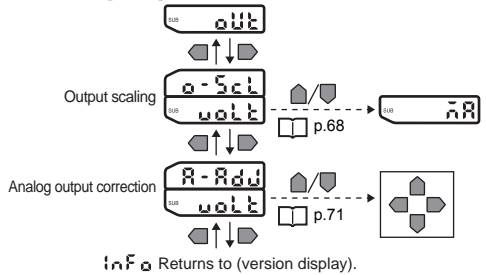

● When [M-LV] is selected:

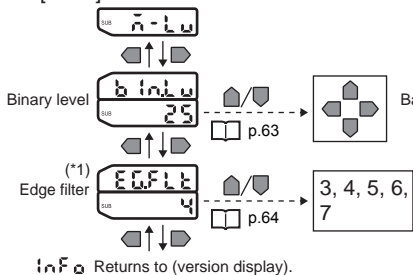

● When [BANK] is selected:

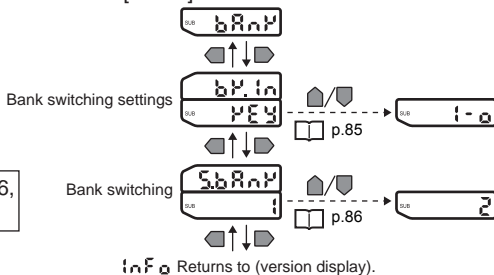

\*1: Displayed only in the wire position measurement mode or glass edge measurement mode. Otherwise, the numerical value is fixed (7).

## T mode

☐ p.45

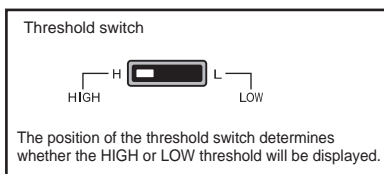
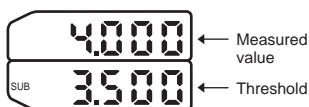

## RUN mode

☐ p.46

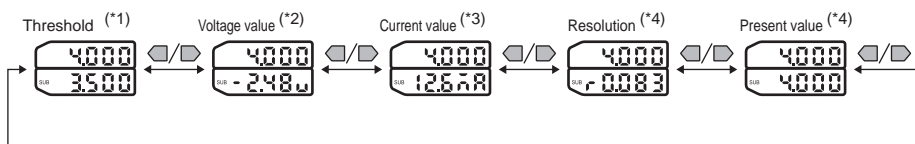

\*1: In the IC lead pitch and IC lead width judgment modes, standard values and tolerances are displayed according to the threshold switch setting.

\*2: In the IC lead pitch and IC lead width judgment modes, "0V" is displayed at all times.

\*3: In the IC lead pitch and IC lead width judgment modes, "4mA" is displayed at all times.

\*4: In the IC lead pitch and IC lead width judgment modes, "0-----" is displayed at all times.

MEMO

# INDEX

## A

---

Adjusting the Display	
Brightness (ECO mode)	79
Adjusting the Optical Axis	42
Assignments and Functions of Signal Wires	
Controller	91
Interface Unit	93
Average	62
AVERAGE command	107
Average hold	74

## B

---

Bank 1 indicator	23
Bank 2 indicator	23
BANK command	127
Bank Control Command	106
Bank Switching	
Change of device setup	86
Binary Level	63
Binary output cable	24
Binary Output Cycle	81
Binary output indicator	24
BINLV command	108
Bottom hold	73

## C

---

Calculating the Measurement Result	59
Calculating Unit	
External dimensions	135
Specifications	135
Center Position Measurement Mode	53
Changing the Number of Display Digits	78
Channel Nos.	38
Command Format	102
Communications Commands	102
Configuration of Measured Value Data	104
Connecting Devices	28
Connecting External Devices	101
Control keys	23
Controller	

Assignments and Functions of I/O Signal Wires	91
Connecting to each other	37
External dimensions	134
I/O Circuit Diagrams	33
Mounting	27
Parts Names and Functions	
Controller	22
Specifications	133
Wiring	30
Controller communications indicator	24
Controller connector	
Controller	22
Interface Unit	24
Correcting Analog Output Values	71

## D

---

DATAINIT command	128
Default Values	142
Delay Hold	75
Delay Time	75
Display during a Zero Reset	83
Displaying the System	
Version	87

## E

---

Edge Filter	64
EDGENUM command	109
EDGEPOS command	123
Emitter	21
Error Messages	
Measurement	140
Setup	140
Standard Received Light Intensity Registration	141
Extension Cable	
External dimensions	138
Specifications	138
Extension cable	
To extend the connection between the receiver and the Controller	29

**F**

FUN Mode	42, 156
----------	---------

**G**

Glass Edge Measurement Mode	58
-----------------------------	----

**H**

High-speed mode (FAST)	61
HOLDMODE command	111
How to count edge Nos.	
EDGEPOS command	124
Specified Edge Measurement Mode	57
How to select the measurement mode	44
HYS Command	113
Hysteresis	67

**I**

IC Lead Pitch Judgment Mode	54
IC Lead Width Judgment Mode	55
Incident Beam Width Measurement Mode	52
Initializing Controller Settings	39
Input cable	22
Interface Unit	
Assignments and Functions of Output Signal Wires	93
Connecting	38
External dimensions	137
I/O Circuit Diagrams	35
Parts Names and Functions	24
Specifications	136
Wiring (output cables)	31
Interrupted Beam Width Measurement Mode	52

**J**

Judgment output indicator	23
Judgment output timing	65
JUDPARA command	114

**K**

Key Functions	143
Key Lock	84

**L**

Laser indicators	21
------------------	----

**M**

Main display indicator	23
MEASMODE command	116
MEASURE command	124
Measurement Control/Measured Value Acquisition Commands	106
Measurement cycle	61
Measurement Mode	50
Mode switch	23

**O**

OFF delay	65
ON delay	65
One-shot	66
Operation Step Guide	16
Optical axis adjustment	42
Optical axis setting indicator	21
Outer Diameter Measurement Mode	53
Output cable	22
Output Data	90
Output Format	94
Output Scaling	68

**P**

Peak hold	73
Peak-to-peak hold	74
PINNO command	118
Power ON indicator	24

**R**

Reading Displays	143
Received light balance display	42
Receiver	21
REF command	120
Registering the Standard	
Received Light Intensity	43
Response Format	102
Reversing the Display	77
RS-232C	
Communication Method	100
Communications indicator	24
Communications Specifications	80

Connector	24
Specifications	100
RUN Mode	46, 159

Indicator	23
Zero Reset Memory	82

## S

Sample hold	73
Sampling Time	75
Sensor	
External dimensions	131
I/O Circuit Diagrams	32
Mounting	25
Parts Names and Functions	21
Specifications	130
Wiring (emitter)	29
Setting Acquisition/Change Commands	105
Setting hold conditions	73
Setting the Bank	
Switching Source	85
Specified Edge Measurement Mode	56
Standard mode (NORM)	61
Sub-display indicator	23
System Configuration	20

## T

T Mode	45, 159
TEACH command	121
Threshold switch	23
Timer Setting	65
Timing Charts	95
TOL command	122

## U

Utility Command	106
-----------------	-----

## V

Voltage/Current switch	22
------------------------	----

## W

Wire Position Measurement Mode	58
--------------------------------	----

## Z

ZERO command	126
Zero reset	
Canceling	47
Executing	47

# Revision History

A manual revision code appears as a suffix to the catalog number at the bottom of the front and back covers of this manual.

Cat. No. Z263-E1-03



Revision code

Revision code	Revision date	Revised content
01	June 2007	Original production
02	November 2013	Pages 2 to 4: Replaced "Warranty and Application Considerations" with "Terms and Conditions Agreement." Page 20: Removed "input triggers and" from callout. Page 30: Replaced paragraph before table. Page 47: Added paragraph at top of page. Page 62: Added information at bottom of page. Page 131: Changed two dimensions. Page 132: Changed two dimensions. Page 134: Changed note 1. Page 144: Change JIS year in table.
03	July 2015	Page 7: Added applicable standards. Page 134: Added callouts to figure. Corrected mistakes.



**OMRON Corporation Industrial Automation Company**  
Kyoto, JAPAN

Contact: [www.ia.omron.com](http://www.ia.omron.com)

*Regional Headquarters*

**OMRON EUROPE B.V.**

**Sensor Business Unit**

Carl-Benz-Str. 4, D-71154 Nufringen, Germany  
Tel: (49) 7032-811-0/Fax: (49) 7032-811-199

**OMRON ASIA PACIFIC PTE. LTD.**

No. 438A Alexandra Road # 05-05/08 (Lobby 2),  
Alexandra Technopark,  
Singapore 119967  
Tel: (65) 6835-3011/Fax: (65) 6835-2711

**OMRON ELECTRONICS LLC**

2895 Greenspoint Parkway, Suite 200  
Hoffman Estates, IL 60169 U.S.A.  
Tel: (1) 847-843-7900/Fax: (1) 847-843-7787

**OMRON (CHINA) CO., LTD.**

Room 2211, Bank of China Tower,  
200 Yin Cheng Zhong Road,  
PuDong New Area, Shanghai, 200120, China  
Tel: (86) 21-5037-2222/Fax: (86) 21-5037-2200

**Authorized Distributor:**

© OMRON Corporation 2007 All Rights Reserved.  
In the interest of product improvement,  
specifications are subject to change without notice.

**Cat. No. Z263-E1-03**

0715